



Superlight LED is a new range of exterior, high performance floodlights in 3 sizes of housing. Particularly high performance LED modules are combined with extremely efficient reflectors for various different light distributions. These floodlights can be used universally for manifold exterior lighting tasks.

Symmetrical or asymmetrical wide beam reflectors can be used for area lighting while the rotationally symmetrical narrow beam reflectors are useful for accent lighting on façades or on the ground. Optimal heat management ensures a high degree of efficiency and longevity of the LED modules. Their sleek and unobtrusive design allows these luminaires to be integrated into any style of architecture.



As pole mount luminaires the floodlights are supplied with a fixing bracket which allows the luminaires to be tilted and turned. A wide range of different light distributions and flexibility of positioning of the luminaires on the pole give the discerning lighting consultant many options for the illumination of exterior spaces.



DEPOT noise protection wall, Niedernberg/Germany
Lighting design: studiocandela, Herford



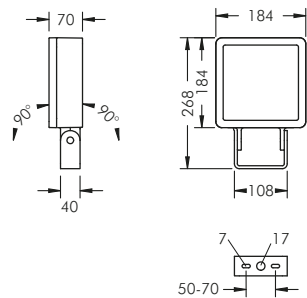

Superlight LED 1

With 1 high performance LED module (Zhaga), integral temperature monitoring device, CRI: > 80, Colour tolerance: max. 3 SDCM Service life: L80/B20 > 50 000 h protection class I, IP67 IK08 windage area AW 0.035 m² corrosion-resistant die cast aluminium housing AlSi12, polyester powder coated, high efficiency reflector, all exterior steel parts are stainless steel, tempered safety glass, silicon gasket, closure with 4 stainless steel screws, mounting bracket powder coated aluminium: 2 drilled holes Ø 7 mm, spacing 50-70 mm, 1 centre hole Ø 17 mm, tilt range 180°, M20 cable gland, integral driver (AC/DC)

Superlight LED 1, rotationally symmetrical narrow beam*

Part number	Colour	Light source	Luminous flux	Beam angle γ (FWHM)
8 885 046 019	black	1 x LED module 27 W	2512 lm	16°
8 885 066 019	white	warm white (3000 K)		
8 885 056 019	silver grey			

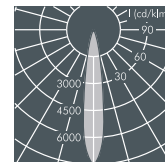
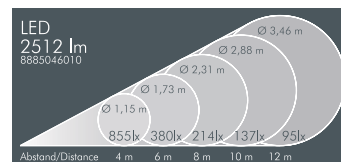

Part number	Colour	Light source	Luminous flux	Beam angle γ (FWHM)
8 885 045 019	black	1 x LED module 27 W	2674 lm	16°
8 885 065 019	white	neutral white (4000 K)		
8 885 055 019	silver grey			

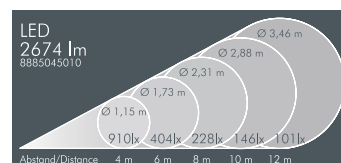

Superlight LED 1, asymmetrical beam*

Part number	Colour	Light source	Luminous flux	Main beam angle γ
8 885 046 049	black	1 x LED module 27 W	2167 lm	45°
8 885 066 049	white	warm white (3000 K)		
8 885 056 049	silver grey			

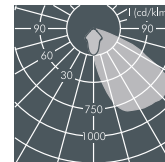
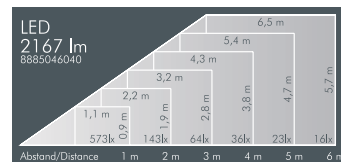

Part number	Colour	Light source	Luminous flux	Main beam angle γ
8 885 045 049	black	1 x LED module 27 W	2303 lm	45°
8 885 065 049	white	neutral white (4000 K)		
8 885 055 049	silver grey			

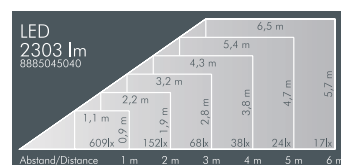

Superlight LED 1, wide beam*

Part number	Colour	Light source	Luminous flux	Beam angle γ (FWHM)	
				C 0 - 180	C 90 - 270
8 885 046 059	black	1 x LED module 27 W	2648 lm	92°	108°
8 885 066 059	white	warm white (3000 K)			
8 885 056 059	silver grey				

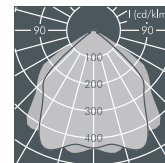
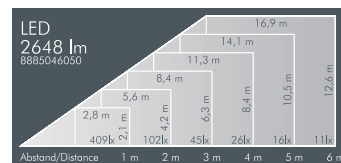

Part number	Colour	Light source	Luminous flux	Beam angle γ (FWHM)	
				C 0 - 180	C 90 - 270
8 885 045 059	black	1 x LED module 27 W	2819 lm	92°	108°
8 885 065 059	white	neutral white (4000 K)			
8 885 055 059	silver grey				

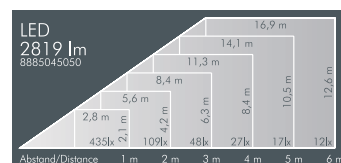

*Luminaires with 2 cable glands are available upon request.

Part number*	Description
... 1 ...	Luminaire with wall arm , internal cable run

*Available upon request in various lengths.

Part number	Description
... 1 ..	Dimmable version (DALI)

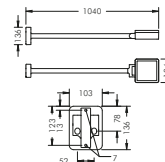

LED (see page 185)

Luminaires available in 2700 K or other colour temperatures on request



Superlight LED 2

With 1 high performance LED module (Zhaga), integral temperature monitoring device, CRI: > 80, Colour tolerance: max. 3 SDCM
 Service life: L80/B20 > 50 000 h
 protection class I, IP67 , IK08
 windage area AW 0.047 m²
 corrosion-resistant die cast aluminium housing AlSi12, polyester powder coated, high efficiency reflector, all exterior steel parts are stainless steel, tempered safety glass, silicon gasket, closure with 4 stainless steel screws, mounting bracket powder coated aluminium: 2 drilled holes Ø 7 mm, spacing 50-70 mm, 1 centre hole Ø 17 mm, tilt range 180°, M20 cable gland, integral driver (AC/DC)

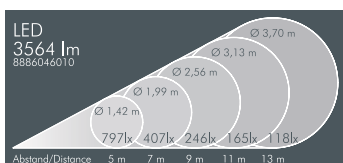
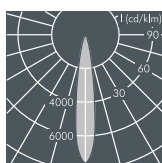
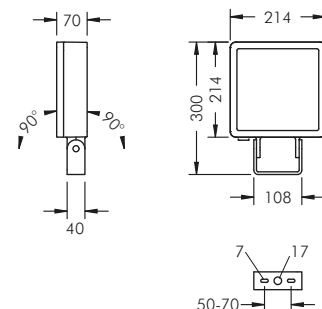

Superlight LED 2, rotationally symmetrical narrow beam*

Part number	Colour	Light source	Luminous flux	Beam angle γ (FWHM)
8 886 046 019	black	1 x LED module 40 W	3564 lm	16°
8 886 066 019	white	warm white (3000 K)		
8 886 056 019	silver grey			

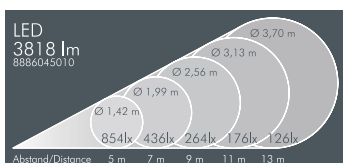

Part number	Colour	Light source	Luminous flux	Beam angle γ (FWHM)
8 886 045 019	black	1 x LED module 40 W	3818 lm	16°
8 886 065 019	white	neutral white (4000 K)		
8 886 055 019	silver grey			

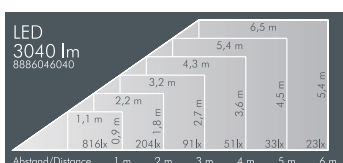
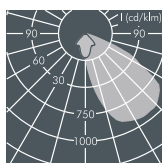

Superlight LED 2, asymmetrical beam*

Part number	Colour	Light source	Luminous flux	Main beam angle γ
8 886 046 049	black	1 x LED module 40 W	3040 lm	45°
8 886 066 049	white	warm white (3000 K)		
8 886 056 049	silver grey			

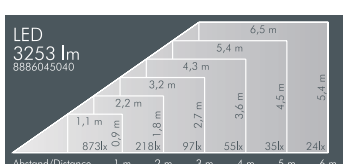

Part number	Colour	Light source	Luminous flux	Main beam angle γ
8 886 045 049	black	1 x LED module 40 W	3253 lm	45°
8 886 065 049	white	neutral white (4000 K)		
8 886 055 049	silver grey			

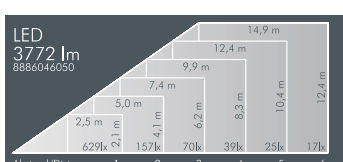
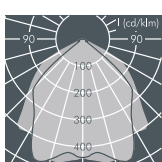

Superlight LED 2, wide beam*

Part number	Colour	Light source	Luminous flux	Beam angle γ (FWHM)
8 886 046 059	black	1 x LED module 40 W	3772 lm	C 0 – 180 C 90 – 270
8 886 066 059	white	warm white (3000 K)		92° 102°
8 886 056 059	silver grey			

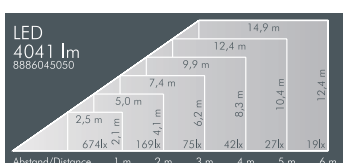

Part number	Colour	Light source	Luminous flux	Beam angle γ (FWHM)
8 886 045 059	black	1 x LED module 40 W	4041 lm	C 0 – 180 C 90 – 270
8 886 065 059	white	neutral white (4000 K)		92° 102°
8 886 055 059	silver grey			

*Luminaires with 2 cable glands are available upon request.

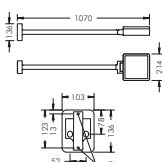

Part number*	Description
... 1... ..	Luminaire with wall arm , internal cable run

*Available upon request in various lengths.

Part number	Description
... .. 1..	Dimmable version (DALI)

LED (see page 185)

Luminaires available in 2700 K or other colour temperatures on request



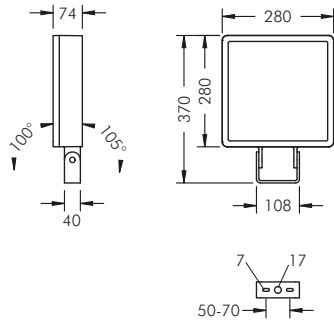

Superlight LED 3

With 2 high performance LED modules (Zhaga), integral temperature monitoring device, CRI: > 80, Colour tolerance: max. 3 SDCM
 Service life: L80/B20 > 50 000 h
 protection class I, IP67 IK08
 windage area AW 0.08 m²
 corrosion-resistant die cast aluminium housing AlSi12, polyester powder coated, high efficiency reflector, all exterior steel parts are stainless steel, tempered safety glass, silicon gasket, closure with 4 stainless steel screws, mounting bracket powder coated aluminium: 2 drilled holes Ø 7 mm, spacing 50-70 mm, 1 centre hole Ø 17 mm, tilt range 205°, M20 cable gland, integral driver (AC/DC)

Superlight LED 3, rotationally symmetrical narrow beam*

Part number	Colour	Light source	Luminous flux	Beam angle γ (FWHM)
8 887 046 019	black	2 x LED module 45 W	8212 lm	16°
8 887 066 019	white	warm white (3000 K)		
8 887 056 019	silver grey			

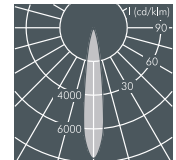
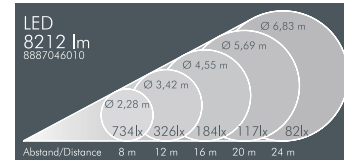

Part number	Colour	Light source	Luminous flux	Beam angle γ (FWHM)
8 887 045 019	black	2 x LED module 45 W	8786 lm	16°
8 887 065 019	white	neutral white (4000 K)		
8 887 055 019	silver grey			

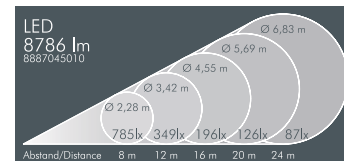

Superlight LED 3, asymmetrical beam*

Part number	Colour	Light source	Luminous flux	Main beam angle γ
8 887 046 049	black	2 x LED module 45 W	7082 lm	45°
8 887 066 049	white	warm white (3000 K)		
8 887 056 049	silver grey			

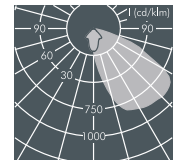
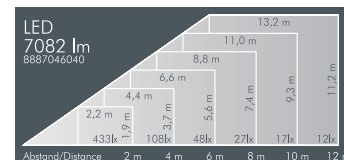

Part number	Colour	Light source	Luminous flux	Main beam angle γ
8 887 045 049	black	2 x LED module 45 W	7578 lm	45°
8 887 065 049	white	neutral white (4000 K)		
8 887 055 049	silver grey			

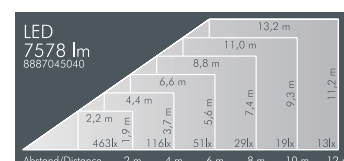

Superlight LED 3, wide beam*

Part number	Colour	Light source	Luminous flux	Beam angle γ (FWHM)	
				C 0 - 180	C 90 - 270
8 887 046 059	black	2 x LED module 45 W	9098 lm	92°	105°
8 887 066 059	white	warm white (3000 K)			
8 887 056 059	silver grey				

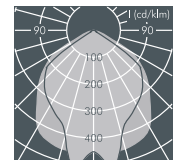
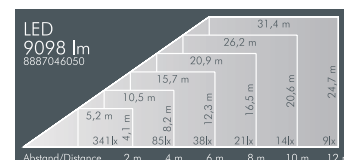

Part number	Colour	Light source	Luminous flux	Beam angle γ (FWHM)	
				C 0 - 180	C 90 - 270
8 887 045 059	black	2 x LED module 45 W	9747 lm	92°	105°
8 887 065 059	white	neutral white (4000 K)			
8 887 055 059	silver grey				

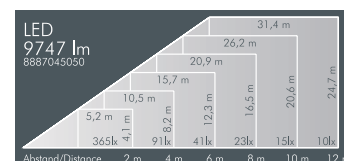

*Luminaires with 2 cable glands are available upon request.

Part number*	Description
... 1 ...	Luminaire with wall arm, internal cable run

*Available upon request in various lengths.

Part number	Description
... 1 ..	Dimmable version (DALI)





LED (see page 185)

Luminaires available in 2700 K or other colour temperatures on request



Superlight LED 3+

With 4 high performance LED modules (Zhaga),
 integral temperature monitoring device,
 CRI: > 80, Colour tolerance: max. 3 SDCM
 Service life: L80/B20 > 50 000 h
 protection class I, IP65   , IK08
 windage area AW 0.08 m²
 corrosion-resistant die cast aluminium housing AlSi12,
 polyester powder coated, high efficiency reflector,
 all exterior steel parts are stainless steel,
 tempered safety glass, silicon gasket,
 closure with 4 stainless steel screws,
 mounting bracket powder coated aluminium:
 2 drilled holes Ø 7 mm, spacing 50-70 mm,
 1 centre hole Ø 17 mm, tilt range 205°,
 M20 cable gland, integral programmable and
 DALI dimmable driver (AC/DC)

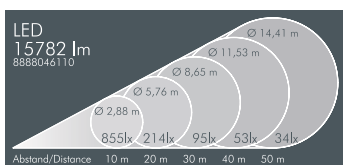
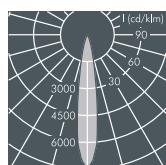
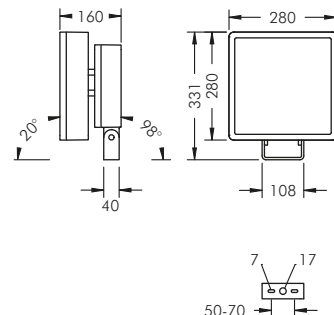

Superlight LED 3+, rotationally symmetrical narrow beam*

Part number	Colour	Light source	Luminous flux	Beam angle γ (FWHM)
8 888 046 119	black	4 x LED module 39 W	15782 lm	16°
8 888 066 119	white	warm white (3000 K)		
8 888 056 119	silver grey			

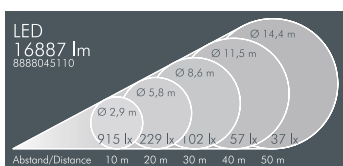

Part number	Colour	Light source	Luminous flux	Beam angle γ (FWHM)
8 888 045 119	black	4 x LED module 39 W	16887 lm	16°
8 888 065 119	white	neutral white (4000 K)		
8 888 055 119	silver grey			

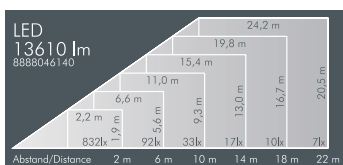
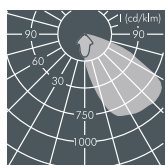

Superlight LED 3+, asymmetrical beam*

Part number	Colour	Light source	Luminous flux	Main beam angle γ
8 888 046 149	black	4 x LED module 39 W	13610 lm	45°
8 888 066 149	white	warm white (3000 K)		
8 888 056 149	silver grey			

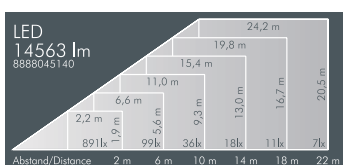

Part number	Colour	Light source	Luminous flux	Main beam angle γ
8 888 045 149	black	4 x LED module 39 W	14563 lm	45°
8 888 065 149	white	neutral white (4000 K)		
8 888 055 149	silver grey			

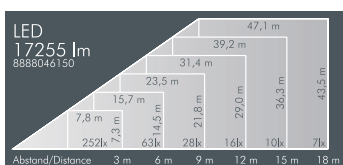
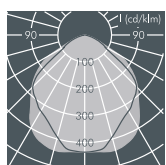

Superlight LED 3+, wide beam*

Part number	Colour	Light source	Luminous flux	Beam angle γ (FWHM)	
				C 0 - 180	C 90 - 270
8 888 046 149	black	4 x LED module 39 W	17255 lm	101°	105°
8 888 066 149	white	warm white (3000 K)			
8 888 056 149	silver grey				

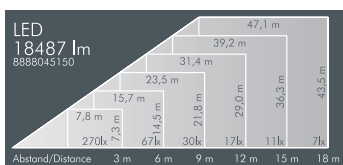

Part number	Colour	Light source	Luminous flux	Beam angle γ (FWHM)	
				C 0 - 180	C 90 - 270
8 888 045 149	black	4 x LED module 39 W	18487 lm	101°	105°
8 888 065 149	white	neutral white (4000 K)			
8 888 055 149	silver grey				

*Luminaires with 2 cable glands are available upon request.

LED (see page 185)

Luminaires available in 2700 K or other colour temperatures on request



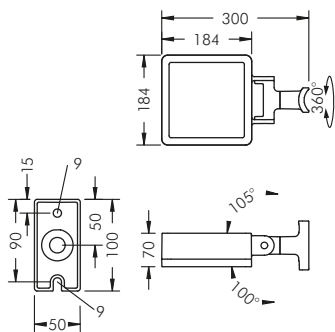

Superlight LED 1, pole luminaire

With 1 high performance LED module (Zhaga), integral temperature monitoring device, CRI: > 80, Colour tolerance: max. 3 SDCM
 Service life: L80/B20 > 50 000 h
 protection class I, IP67 , IK08
 windage area AW 0.035 m²
 corrosion-resistant die cast aluminium housing AlSi12, polyester powder coated, high efficiency reflector, all exterior steel parts are stainless steel, tempered safety glass, silicon gasket, closure with 4 stainless steel screws, for installation on poles Ø 60 - 100 mm, powder coated aluminium mounting base: 2 drilled holes Ø 9 mm, spacing 75 mm, 1 centre hole Ø 17 mm, tilt range 205°, swivel range 360°, M20 cable gland, integral driver (AC/DC)

Superlight LED 1, pole luminaire, rotationally symmetrical narrow beam

Part number	Colour	Light source	Luminous flux	Beam angle γ (FWHM)
8 885 246 019	black	1 x LED module 27 W	2512 lm	16°
8 885 266 019	white	warm white (3000 K)		
8 885 256 019	silver grey			

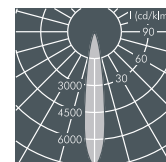
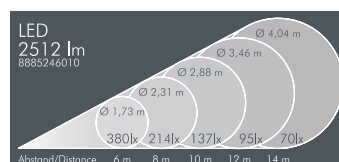

Part number	Colour	Light source	Luminous flux	Beam angle γ (FWHM)
8 885 245 019	black	1 x LED module 27 W	2674 lm	16°
8 885 265 019	white	neutral white (4000 K)		
8 885 255 019	silver grey			

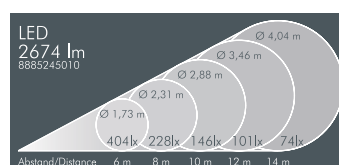

Superlight LED 1, pole luminaire, asymmetrical beam

Part number	Colour	Light source	Luminous flux	Main beam angle γ
8 885 246 049	black	1 x LED module 27 W	2167 lm	45°
8 885 266 049	white	warm white (3000 K)		
8 885 256 049	silver grey			

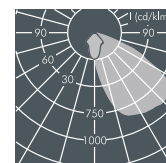
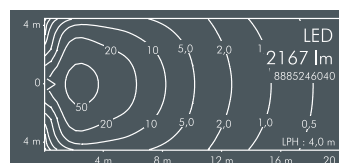

Part number	Colour	Light source	Luminous flux	Main beam angle γ
8 885 245 049	black	1 x LED module 27 W	2303 lm	45°
8 885 265 049	white	neutral white (4000 K)		
8 885 255 049	silver grey			

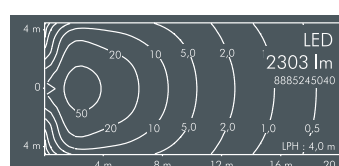

Superlight LED 1, pole luminaire, wide beam

Part number	Colour	Light source	Luminous flux	Beam angle γ (FWHM)	
				C 0 - 180	C 90 - 270
8 885 246 059	black	1 x LED module 27 W	2648 lm	92°	108°
8 885 266 059	white	warm white (3000 K)			
8 885 256 059	silver grey				

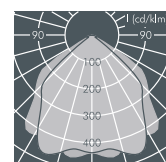
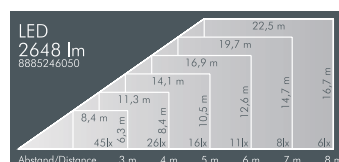

Part number	Colour	Light source	Luminous flux	Beam angle γ (FWHM)	
				C 0 - 180	C 90 - 270
8 885 245 059	black	1 x LED module 27 W	2819 lm	92°	108°
8 885 265 059	white	neutral white (4000 K)			
8 885 255 059	silver grey				

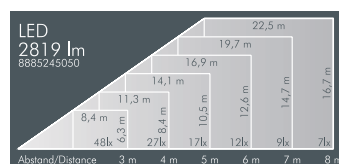

Part number	Description
. 1..	Dimmable version (DALI)

LED (see page 185)

Luminaires available in 2700 K or other colour temperatures on request



Superlight LED 2, pole luminaire

With 1 high performance LED module (Zhaga),
 integral temperature monitoring device,
 CRI: > 80, Colour tolerance: max. 3 SDCM
 Service life: L80/B20 > 50 000 h
 protection class I, IP67 , IK08
 windage area AW 0.047 m²
 corrosion-resistant die cast aluminium housing AlSi12,
 polyester powder coated, high efficiency reflector,
 all exterior steel parts are stainless steel,
 tempered safety glass, silicon gasket,
 closure with 4 stainless steel screws,
 for installation on poles Ø 60 - 100 mm,
 powder coated aluminium mounting base:
 2 drilled holes Ø 9 mm, spacing 75 mm,
 1 centre hole Ø 17 mm, tilt range 205°,
 swivel range 360°, M20 cable gland,
 integral driver (AC/DC)

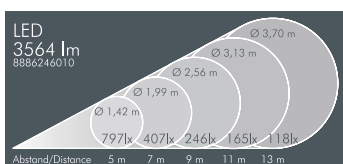
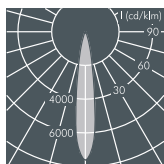
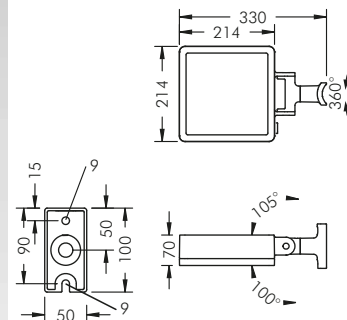

Superlight LED 2, pole luminaire, rotationally symmetrical narrow beam

Part number	Colour	Light source	Luminous flux	Beam angle γ (FWHM)
8 886 246 019	black	1 x LED module 40 W	3564 lm	16°
8 886 266 019	white	warm white (3000 K)		
8 886 256 019	silver grey			

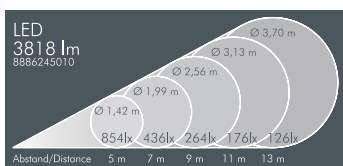

Part number	Colour	Light source	Luminous flux	Beam angle γ (FWHM)
8 886 245 019	black	1 x LED module 40 W	3818 lm	16°
8 886 265 019	white	neutral white (4000 K)		
8 886 255 019	silver grey			

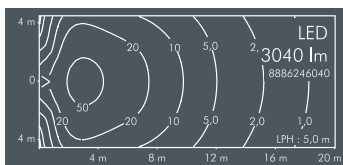
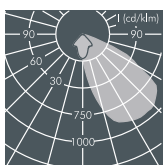

Superlight LED 2, pole luminaire, asymmetrical beam

Part number	Colour	Light source	Luminous flux	Main beam angle γ
8 886 246 049	black	1 x LED module 40 W	3040 lm	45°
8 886 266 049	white	warm white (3000 K)		
8 886 256 049	silver grey			

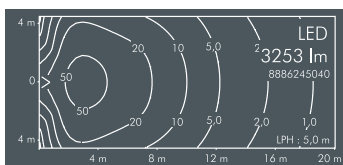
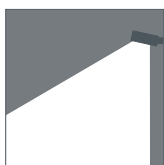

Part number	Colour	Light source	Luminous flux	Main beam angle γ
8 886 245 049	black	1 x LED module 40 W	3253 lm	45°
8 886 265 049	white	neutral white (4000 K)		
8 886 255 049	silver grey			

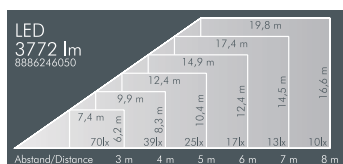
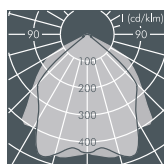

Superlight LED 2, pole luminaire, wide beam

Part number	Colour	Light source	Luminous flux	Beam angle γ (FWHM)	
				C 0 - 180	C 90 - 270
8 886 246 059	black	1 x LED module 40 W	3772 lm	92°	102°
8 886 266 059	white	warm white (3000 K)			
8 886 256 059	silver grey				

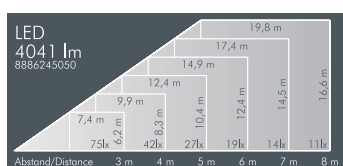

Part number	Colour	Light source	Luminous flux	Beam angle γ (FWHM)	
				C 0 - 180	C 90 - 270
8 886 245 059	black	1 x LED module 40 W	4041 lm	92°	102°
8 886 265 059	white	neutral white (4000 K)			
8 886 255 059	silver grey				

Part number	Description
... .. 1 ..	Dimmable version (DALI)

LED (see page 185)

Luminaires available in 2700 K or other colour temperatures on request



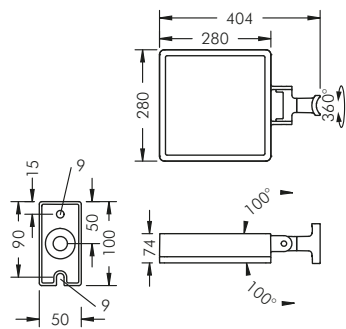

Superlight LED 3, pole luminaire

With 2 high performance LED modules (Zhaga), integral temperature monitoring device, CRI: > 80, Colour tolerance: max. 3 SDCM
 Service life: L80/B20 > 50 000 h
 protection class I, IP67, IK08
 windage area AW 0.08 m²
 corrosion-resistant die cast aluminium housing AlSi12, polyester powder coated, high efficiency reflector, all exterior steel parts are stainless steel, tempered safety glass, silicon gasket, closure with 4 stainless steel screws, for installation on poles Ø 60 - 100 mm, powder coated aluminium mounting base: 2 drilled holes Ø 9 mm, spacing 75 mm, 1 centre hole Ø 17 mm, tilt range 200°, swivel range 360°, M20 cable gland, integral driver (AC/DC)

Superlight LED 3, pole luminaire, rotationally symmetrical narrow beam

Part number	Colour	Light source	Luminous flux	Beam angle γ (FWHM)
8 887 246 019	black	2 x LED module 45 W	8212 lm	16°
8 887 266 019	white	warm white (3000 K)		
8 887 256 019	silver grey			

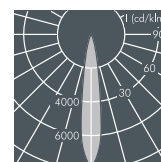
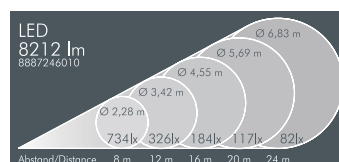

Part number	Colour	Light source	Luminous flux	Beam angle γ (FWHM)
8 887 245 019	black	2 x LED module 45 W	8786 lm	16°
8 887 265 019	white	neutral white (4000 K)		
8 887 255 019	silver grey			

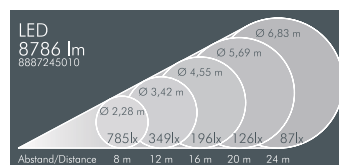

Superlight LED 3, pole luminaire, asymmetrical beam

Part number	Colour	Light source	Luminous flux	Main beam angle γ
8 887 246 049	black	2 x LED module 45 W	7082 lm	45°
8 887 266 049	white	warm white (3000 K)		
8 887 256 049	silver grey			

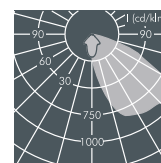
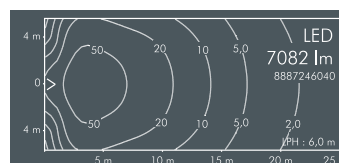

Part number	Colour	Light source	Luminous flux	Main beam angle γ
8 887 245 049	black	2 x LED module 45 W	7578 lm	45°
8 887 265 049	white	neutral white (4000 K)		
8 887 255 049	silver grey			

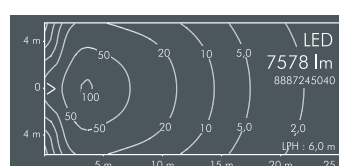

Superlight LED 3, pole luminaire, wide beam

Part number	Colour	Light source	Luminous flux	Beam angle γ (FWHM)	
				C 0 - 180	C 90 - 270
8 887 246 059	black	2 x LED module 45 W	9098 lm	92°	105°
8 887 266 059	white	warm white (3000 K)			
8 887 256 059	silver grey				

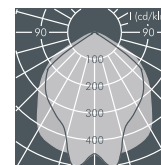
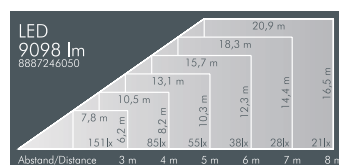

Part number	Colour	Light source	Luminous flux	Beam angle γ (FWHM)	
				C 0 - 180	C 90 - 270
8 887 245 059	black	2 x LED module 45 W	9747 lm	92°	105°
8 887 265 059	white	neutral white (4000 K)			
8 887 255 059	silver grey				

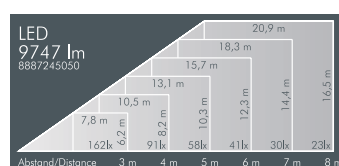

Part number	Description
... 1..	Dimmable version (DALI)

LED (see page 185)

Luminaires available in 2700 K or other colour temperatures on request



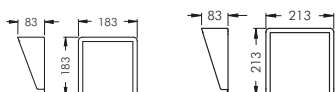

Accessories Superlight LED 1, LED 2

Part number LED 1	Part number LED 2	Colour	Description
128 0 792 940	128 0 793 940	black	Cowl , aluminium, to avoid glare from 3 directions, for mounting on front of floodlight
128 0 792 960	128 0 793 960	white	
128 0 792 950	128 0 793 950	silver grey	

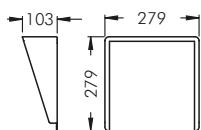

Accessories Superlight LED 3, LED 3+

Part number	Colour	Description
128 0 794 940	black	Cowl , aluminium, to avoid glare from 3 directions, for mounting on front of floodlight
128 0 794 960	white	
128 0 794 950	silver grey	

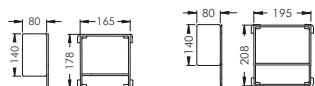

Accessories Superlight LED 1, LED 2

Part number LED 1	Part number LED 2	Colour	Description
128 0 797 940	128 0 798 940	black	Barn doors , aluminium, to avoid glare from 4 directions, variable control of light distribution
128 0 797 960	128 0 798 960	white	
128 0 797 950	128 0 798 950	silver grey	

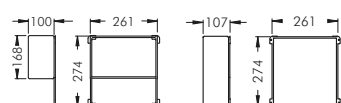

Accessories Superlight LED 3, LED 3+

Part number LED 3	Part number LED 3+	Colour	Description
128 0 799 940	128 0 909 940	black	Barn doors , aluminium, to avoid glare from 4 directions, variable control of light distribution
128 0 799 960	128 0 909 960	white	
128 0 799 950	128 0 909 950	silver grey	

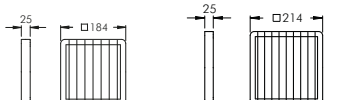

Accessories Superlight LED 1, LED 2

Part number LED 1	Part number LED 2	Colour	Description
128 0 802 940	128 0 803 940	black	Vertical/Horizontal louvre , stainless steel, to reduce lateral glare, for mounting on front of floodlight
128 0 802 960	128 0 803 960	white	
128 0 802 950	128 0 803 950	silver grey	

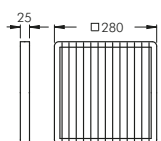

Accessories Superlight LED 3, LED 3+

Part number	Colour	Description
128 0 804 940	black	Vertical/Horizontal louvre , stainless steel, to reduce lateral glare, for mounting on front of floodlight
128 0 804 960	white	
128 0 804 950	silver grey	

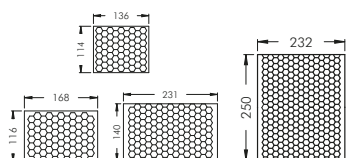

Accessories Superlight LED 1, LED 2, LED 3, LED 3+ rotationally symmetrical narrow beam and wide beam

Part number	Luminaire	Description
128 0 810 000	LED 1	Honeycomb louvre , internally fitted, to avoid glare
128 0 811 000	LED 2	
128 0 812 000	LED 3	
128 0 908 000	LED 3+	



Accessories Superlight LED 1, LED 2, LED 3, LED 3+ rotationally symmetrical narrow beam

Part number	Luminaire	Description	Half beam angle γ	
			C 0 - 180	C 90 - 270
128 0 807 000	LED 1	Ribbed glass , internally fitted, for linear beam control, continuously adjustable 360°	20°	29°
128 0 808 000	LED 2		20°	29°
128 0 809 000	LED 3		20°	29°
128 0 910 000	LED 3+		20°	29°

Colour filters*, to be installed inside luminaires, are available upon request.

*for rotationally symmetrical narrow beam and wide beam

