

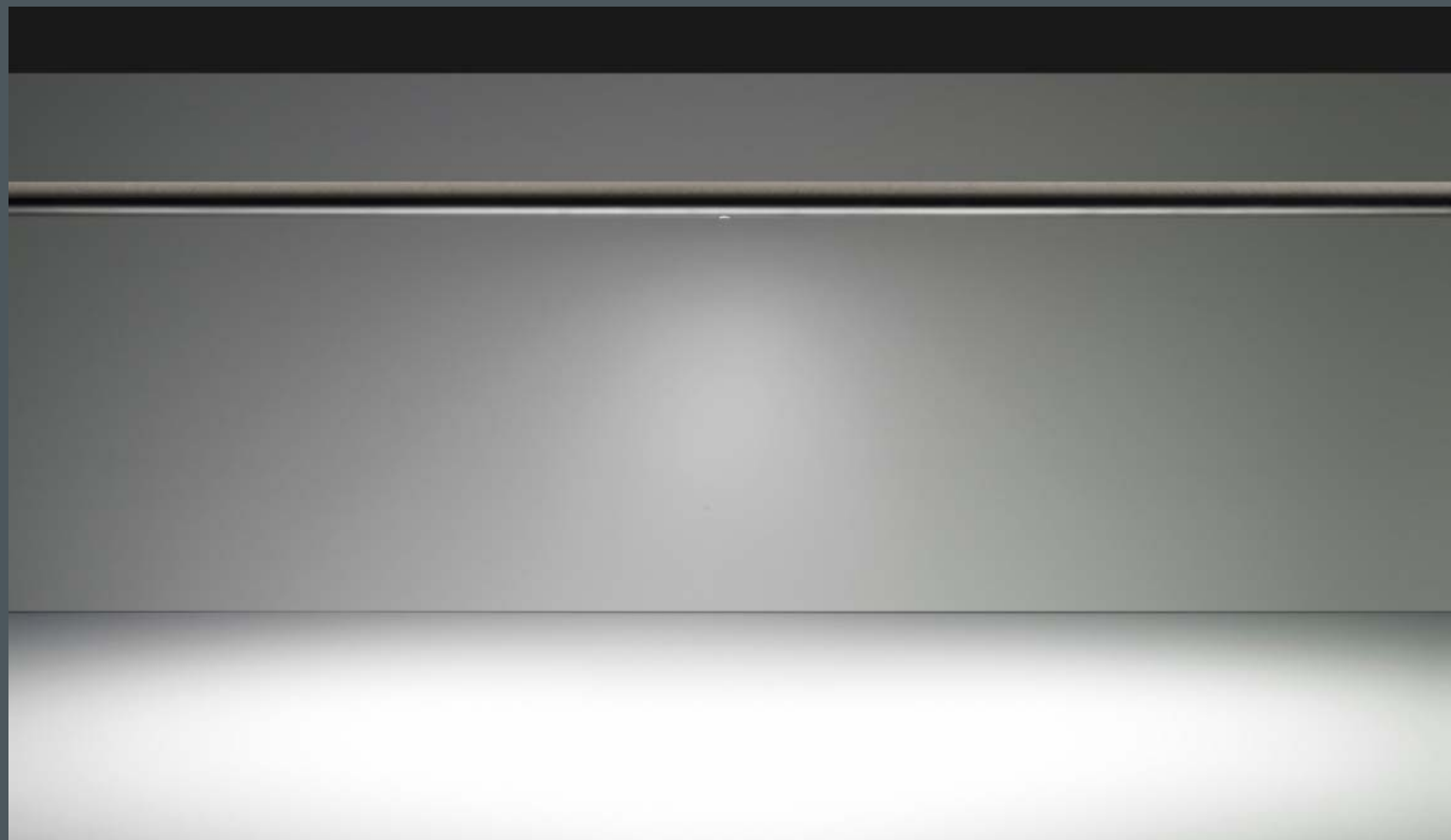

New Products 2021/2022



Nanodot are miniature luminaires for recess installation into round handrails made of metal. Discreet and completely glare-free, these luminaires achieve uniform illumination on paths and stairs next to railings. Precise optics create asymmetrical or wide beam light distributions and make large luminaire spacings possible. The luminaires can be retro-fitted into existing handrails on site.



The extremely small luminaires are recessed into handrails and built-in flush with the surface. For protection against theft, the use of a special tool is necessary to take out the luminaires.



Alternatively, the luminaires are available with asymmetrical or with wide beam light distribution.



Nanodot luminaires that are built into handrails, provide uniform and secure illumination on paths and stairs.



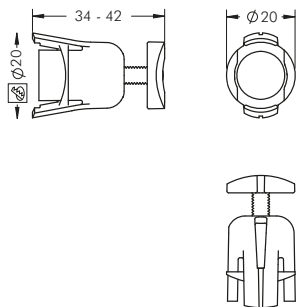

Nanodot handrail luminaire

With 1 x high performance LED,
 CRI: > 80, Colour tolerance: max. 2 SDCM
 Service life: L90/B10 > 50 000 h
 protection class III ⚡, IP65 ⚡⚡, IK10
 luminaire made of corrosion-resistant stainless steel (V4A),
 for flush mounting into round handrails,
 suitable for outer diameter 38 - 45 mm,
 precise light control with miniature polycarbonate optic,
 installation housing made of fibreglass reinforced plastic,
 2 x 130 mm FEP single wires and
 2 x IP67 silicone-potted pressure clamp connectors,
 suitable for connection to remote constant current
 power supply max. 500 mA

Nanodot, lateral wide beam

Part number	Handrail Ø*	Light source	Luminous flux	Beam angle γ (FWHM)	
8 400 016 089	38 - 45 mm	1 x LED 1.5 W warm white (3000 K)	162 lm	C 0 - 180 30°	C 90 - 270 105°

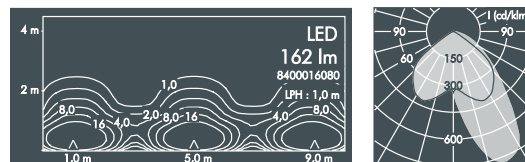

Part number	Handrail Ø*	Light source	Luminous flux	Beam angle γ (FWHM)	
8 400 015 089	38 - 45 mm	1 x LED 1.5 W neutral white (4000 K)	171 lm	C 0 - 180 30°	C 90 - 270 105°

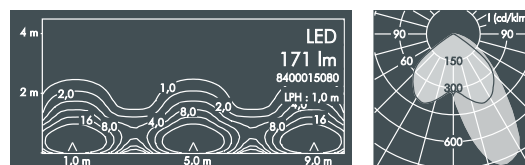

Nanodot, asymmetrical beam

Part number	Handrail Ø*	Light source	Luminous flux	Main beam angle γ
8 400 016 099	38 - 45 mm	1 x LED 1.5 W warm white (3000 K)	151 lm	43°

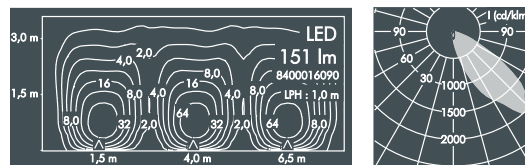

Part number	Handrail Ø*	Light source	Luminous flux	Main beam angle γ
8 400 015 099	38 - 45 mm	1 x LED 1.5 W neutral white (4000 K)	160 lm	43°

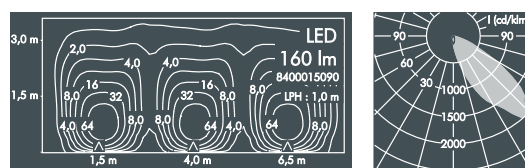

*Luminaires available for handrails with different outer diameters upon request.

LED

Luminaires available in 2700 K and other colour temperatures upon request



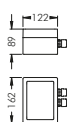

Accessories Nanodot

Part number	Description
	Power supply , grey, weather-resistant polycarbonate, IP67, IK08, integral constant current driver (AC/DC) preset to 500 mA, 2 x M20 cable glands for cable diameter 5 -14 mm
114 0 042 000	for 1 - 7 luminaires (max. 12 W)
114 0 042 100	for 1 - 7 luminaires dimmable (DALI) (max. 12 W)
114 0 052 100	for 4 - 13 luminaires dimmable (DALI) (max. 20 W)



Part number	Description
230 2 606 000	Screwdriver , with allen ball head 2.5 mm, tool for luminaire installation

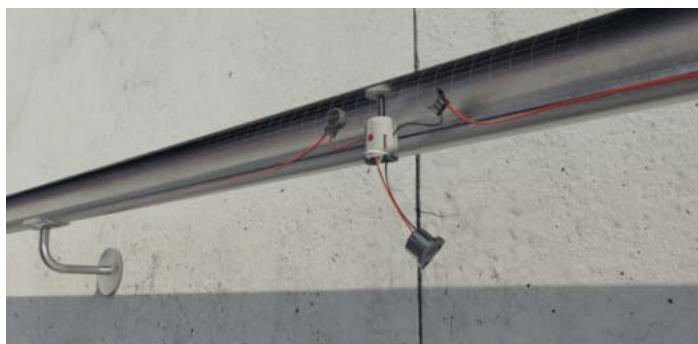

After completing the electrical connection, the plastic installation housing is inserted. The luminaires are mounted flush with the handrail. To explain this installation, there is a video on our website www.meyer-lighting.com.



Monoline are façade luminaires with minimalist design and very small dimensions. Innovative wall washer optics create a uniform light distribution with clearly defined contours. In addition, luminaires with narrow beam or asymmetrical light distributions are available for various different façade lighting applications. Mounting options include a bracket and a wall arm to extend over wall protrusions to optimise the uniformity of the illumination.

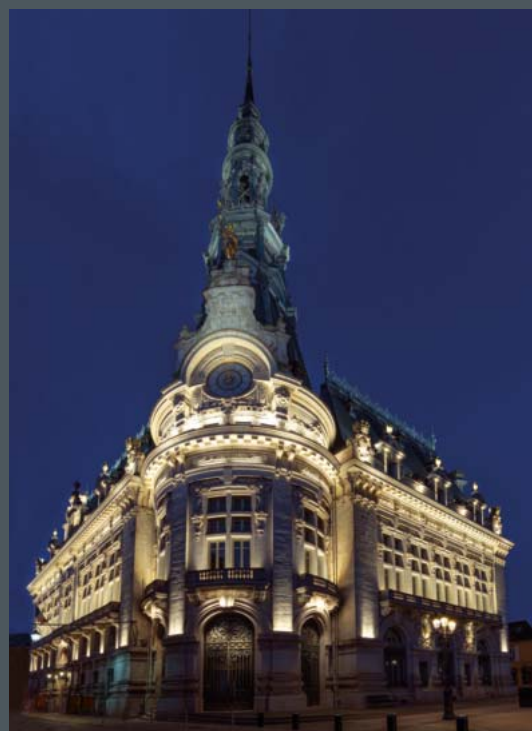

Hôtel de Ville, Sens
Lighting design:
Vittorio Sparta – Atelier Eclar
Photo: Michel Djaoui

For accent lighting applications, the luminaires feature narrow beam optics with minimal stray light.



Monoline is available in 2 sizes and wattages. Discrete installation and easy connection to mains voltage power supply is made possible by the small dimensions of the luminaires and by integral LED drivers.

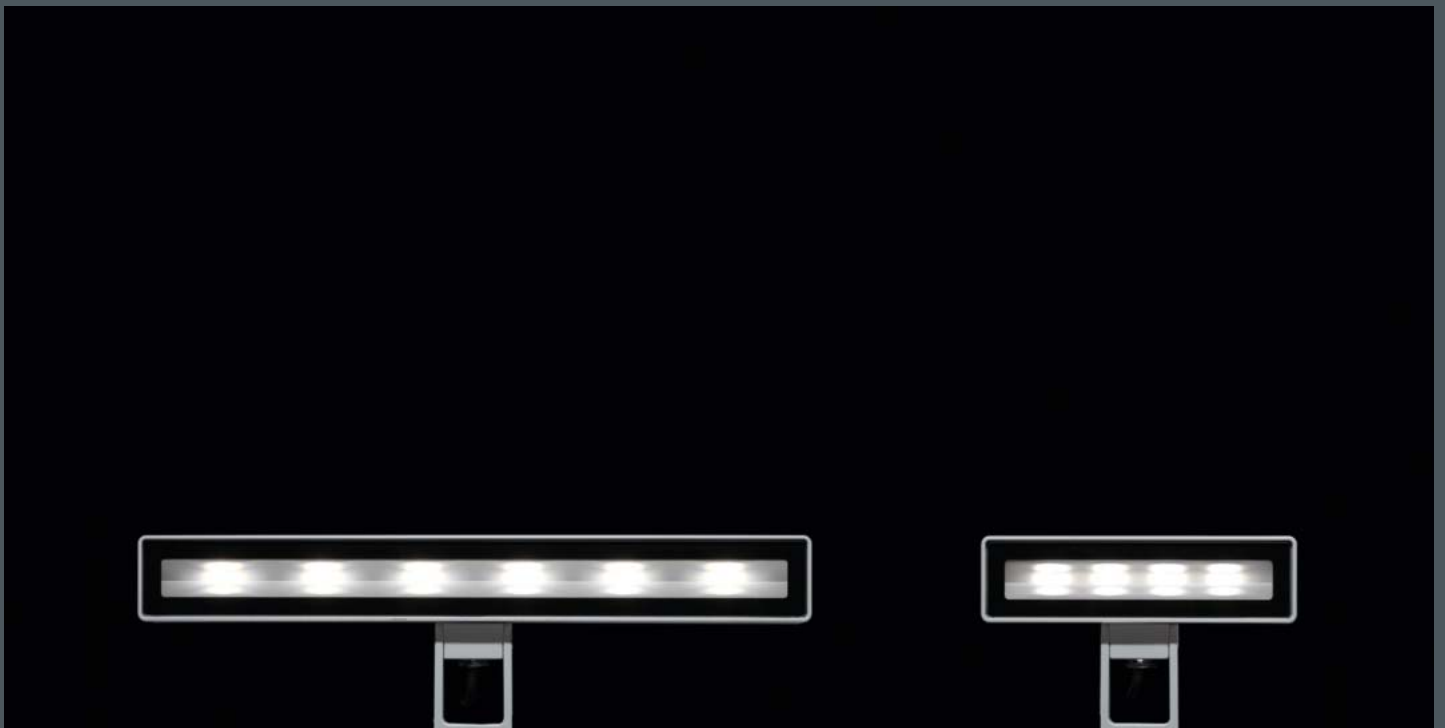

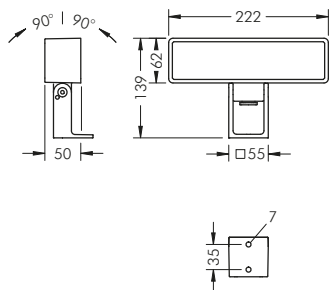

Monoline 1 with wall bracket

With high performance LEDs, integral temperature monitoring device, CRI: > 80, Colour tolerance: max. 3 SDCM
 Service life: L80/B10 > 50 000 h
 protection class I, IP65 \triangle \triangle \triangle , IK08
 windage area AW 0.016 m²
 corrosion-resistant die cast aluminium housing AlSi12, polyester powder coated, all exterior steel parts are stainless steel, tempered safety glass, silicon gasket, closure with 4 stainless steel screws, wall bracket: 2 drilled holes \varnothing 7 mm, spacing 35 mm, tilt range 180°, M20 cable gland, integral driver (AC/DC)

Monoline 1, narrow beam

Part number	Colour	Weight	Light source	Luminous flux	Beam angle γ (FWHM)
8 780 146 019	black	1.2 kg	4 x LED 2.5 W	907 lm	12°
8 780 166 019	white		(10 W)		
8 780 156 019	silver grey		warm white (3000 K)		

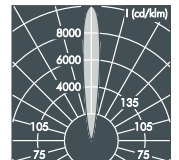
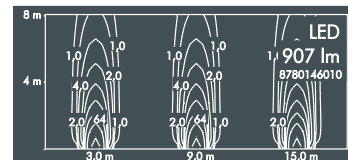

Part number	Colour	Weight	Light source	Luminous flux	Beam angle γ (FWHM)
8 780 145 019	black	1.2 kg	4 x LED 2.5 W	979 lm	12°
8 780 165 019	white		(10 W)		
8 780 155 019	silver grey		neutral white (4000 K)		

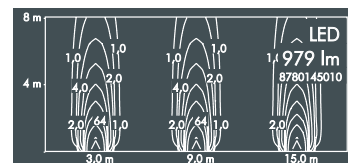

Monoline 1, wall washer

Part number	Colour	Weight	Light source	Luminous flux	Beam angle γ (FWHM)
8 780 146 009	black	1.2 kg	4 x LED 2.5 W	597 lm	C 0 – 180
8 780 166 009	white		(10 W)		C 90 – 270
8 780 156 009	silver grey		warm white (3000 K)		34°

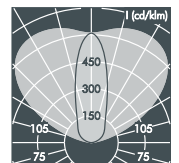
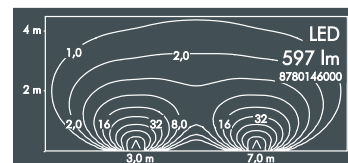

Part number	Colour	Weight	Light source	Luminous flux	Beam angle γ (FWHM)
8 780 145 009	black	1.2 kg	4 x LED 2.5 W	644 lm	C 0 – 180
8 780 165 009	white		(10 W)		C 90 – 270
8 780 155 009	silver grey		neutral white (4000 K)		34°

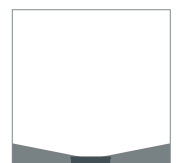
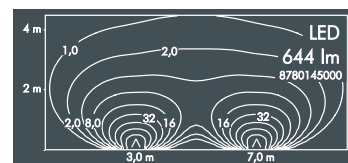

Monoline 1, asymmetrical beam

Part number	Colour	Weight	Light source	Luminous flux	Main beam angle γ
8 780 146 089	black	1.2 kg	4 x LED 2.5 W	701 lm	35°
8 780 166 089	white		(10 W)		
8 780 156 089	silver grey		warm white (3000 K)		

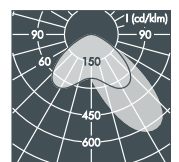
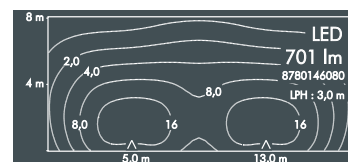

Part number	Colour	Weight	Light source	Luminous flux	Main beam angle γ
8 780 145 089	black	1.2 kg	4 x LED 2.5 W	758 lm	35°
8 780 165 089	white		(10 W)		
8 780 155 089	silver grey		neutral white (4000 K)		

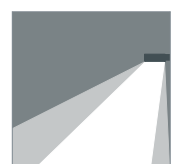
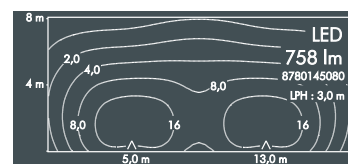

Part number	Description
... .. 1..	Dimmable luminaire (DALI)
... .. 4..	Luminaire with 2 cable glands for through wiring
... .. 5..	Luminaire dimmable version (DALI) with 2 cable glands for through wiring

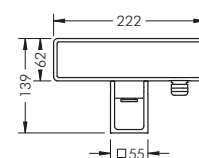

LED

Luminaires available in 2700 K and other colour temperatures upon request



Monoline 1 with wall arm

With high performance LEDs,
 integral temperature monitoring device,
 CRI: > 80, Colour tolerance: max. 3 SDCM
 Service life: L80/B10 > 50 000 h
 protection class I, IP65 , IK08
 windage area AW 0.021 m²
 corrosion-resistant die cast aluminium housing AlSi12,
 polyester powder coated,
 all exterior steel parts are stainless steel,
 tempered safety glass,
 silicon gasket, closure with 4 stainless steel screws,
 mounting plate: 2 drilled holes Ø 7 mm,
 spacing 45 mm, joint with tilt range 180°,
 M20 cable gland,
 integral driver (AC/DC)

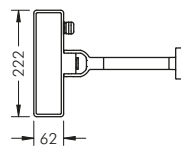
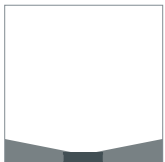
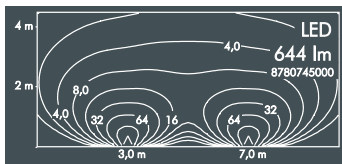
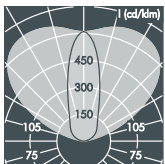
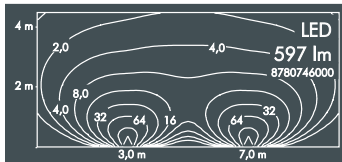
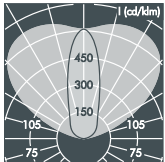
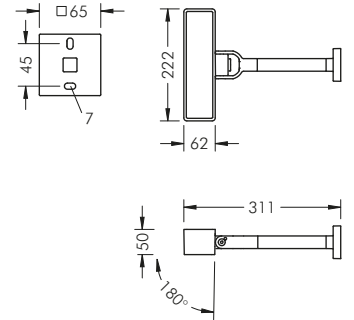

Monoline 1, wall washer with wall arm

Part number	Colour	Weight	Light source	Luminous flux	Beam angle γ (FWHM)	
8 780 746 009	black	1.4 kg	4 x LED 2.5 W (10 W)	597 lm	C 0 – 180	C 90 – 270
8 780 766 009	white				34°	126°
8 780 756 009	silver grey					

Part number	Colour	Weight	Light source	Luminous flux	Beam angle γ (FWHM)	
8 780 745 009	black	1.4 kg	4 x LED 2.5 W (10 W)	644 lm	C 0 – 180	C 90 – 270
8 780 765 009	white				34°	126°
8 780 755 009	silver grey					

Part number	Description
..... 1 ..	Dimmable luminaire (DALI)
..... 4 ..	Luminaire with 2 cable glands for through wiring
..... 5 ..	Luminaire dimmable version (DALI) with 2 cable glands for through wiring

LED

Luminaires available in 2700 K and other colour temperatures upon request



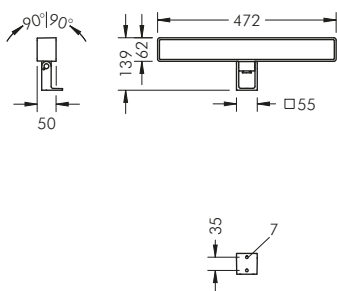

Monoline 2 with wall bracket

With high performance LEDs, integral temperature monitoring device, CRI: > 80, Colour tolerance: max. 3 SDCM
 Service life: L80/B10 > 50 000 h
 protection class I, IP65 , IK08
 windage area AW 0.032 m²
 corrosion-resistant die cast aluminium housing AlSi12, polyester powder coated,
 all exterior steel parts are stainless steel, tempered safety glass,
 silicon gasket, closure with 4 stainless steel screws,
 wall bracket: 2 drilled holes Ø 7 mm, spacing 35 mm, tilt range 180°, M20 cable gland,
 integral driver (AC/DC)

Monoline 2, narrow beam

Part number	Colour	Weight	Light source	Luminous flux	Beam angle γ (FWHM)
8 781 146 019	black	2.1 kg	6 x LED 4.7 W (28 W)	2539 lm	12°
8 781 166 019	white				
8 781 156 019	silver grey				

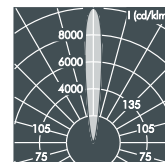
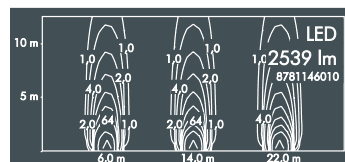

Part number	Colour	Weight	Light source	Luminous flux	Beam angle γ (FWHM)
8 781 145 019	black	2.1 kg	6 x LED 4.7 W (28 W)	2741 lm	12°
8 781 165 019	white				
8 781 155 019	silver grey				

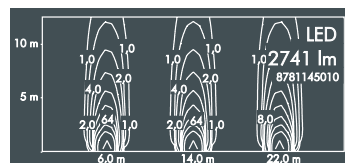

Monoline 2, wall washer

Part number	Colour	Weight	Light source	Luminous flux	Beam angle γ (FWHM)	
8 781 146 009	black	2.1 kg	6 x LED 4.7 W (28 W)	1520 lm	C 0 – 180	C 90 – 270
8 781 166 009	white				32°	128°
8 781 156 009	silver grey					

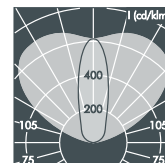
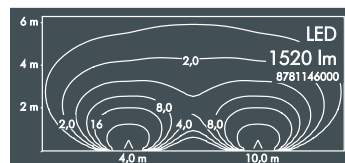

Part number	Colour	Weight	Light source	Luminous flux	Beam angle γ (FWHM)	
8 781 145 009	black	2.1 kg	6 x LED 4.7 W (28 W)	1597 lm	C 0 – 180	C 90 – 270
8 781 165 009	white				32°	128°
8 781 155 009	silver grey					

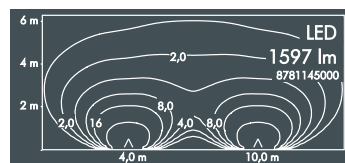

Monoline 2, asymmetrical beam

Part number	Colour	Weight	Light source	Luminous flux	Main beam angle γ
8 781 146 089	black	2.1 kg	6 x LED 4.7 W (28 W)	1964 lm	35°
8 781 166 089	white				
8 781 156 089	silver grey				

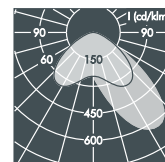
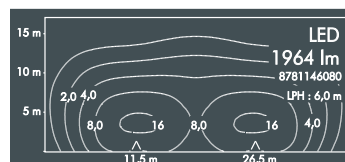

Part number	Colour	Weight	Light source	Luminous flux	Main beam angle γ
8 781 145 089	black	2.1 kg	6 x LED 4.7 W (28 W)	2122 lm	35°
8 781 165 089	white				
8 781 155 089	silver grey				

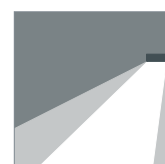
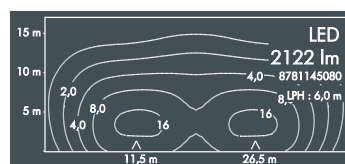

Part number	Description
..... 1..	Dimmable luminaire (DALI)
..... 4..	Luminaire with 2 cable glands for through wiring
..... 5..	Luminaire dimmable version (DALI) with 2 cable glands for through wiring

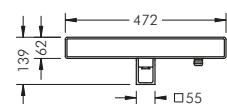

LED

Luminaires available in 2700 K and other colour temperatures upon request

Monoline 2 with wall arm

With high performance LEDs,
 integral temperature monitoring device,
 CRI: > 80, Colour tolerance: max. 3 SDCM
 Service life: L80/B10 > 50 000 h
 protection class I, IP65 , IK08
 windage area AW 0.037 m²
 corrosion-resistant die cast aluminium housing AlSi12,
 polyester powder coated,
 all exterior steel parts are stainless steel,
 tempered safety glass,
 silicon gasket, closure with 4 stainless steel screws,
 mounting plate: 2 drilled holes Ø 7 mm,
 spacing 45 mm, joint with tilt range 180°,
 M20 cable gland,
 integral driver (AC/DC)

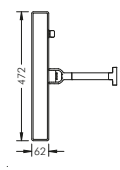
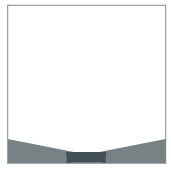
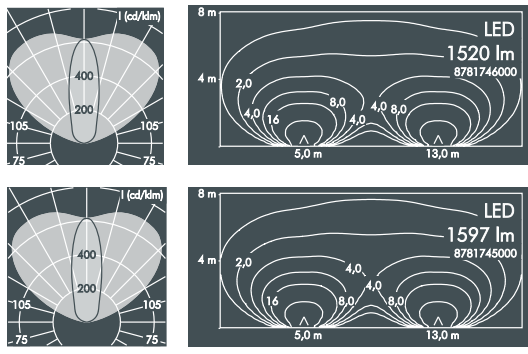
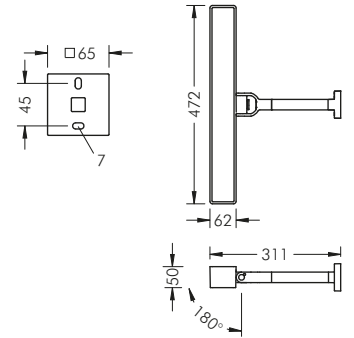

Monoline 2 wall washer with wall arm					
Part number	Colour	Weight	Light source	Luminous flux	Beam angle γ (FWHM)
8 781 746 009	black	2.3 kg	6 x LED 4.7 W (28 W) warm white (3000 K)	1520 lm	C 0 – 180
8 781 766 009	white				C 90 – 270
8 781 756 009	silver grey				32°

Part number	Colour	Weight	Light source	Luminous flux	Beam angle γ (FWHM)
8 781 745 009	black	2.3 kg	6 x LED 4.7 W (28 W) neutral white (4000 K)	1597 lm	C 0 – 180
8 781 765 009	white				C 90 – 270
8 781 755 009	silver grey				32°

Part number	Description
..... 1 ..	Dimmable luminaire (DALI)
..... 4 ..	Luminaire with 2 cable glands for through wiring
..... 5 ..	Luminaire dimmable version (DALI) with 2 cable glands for through wiring

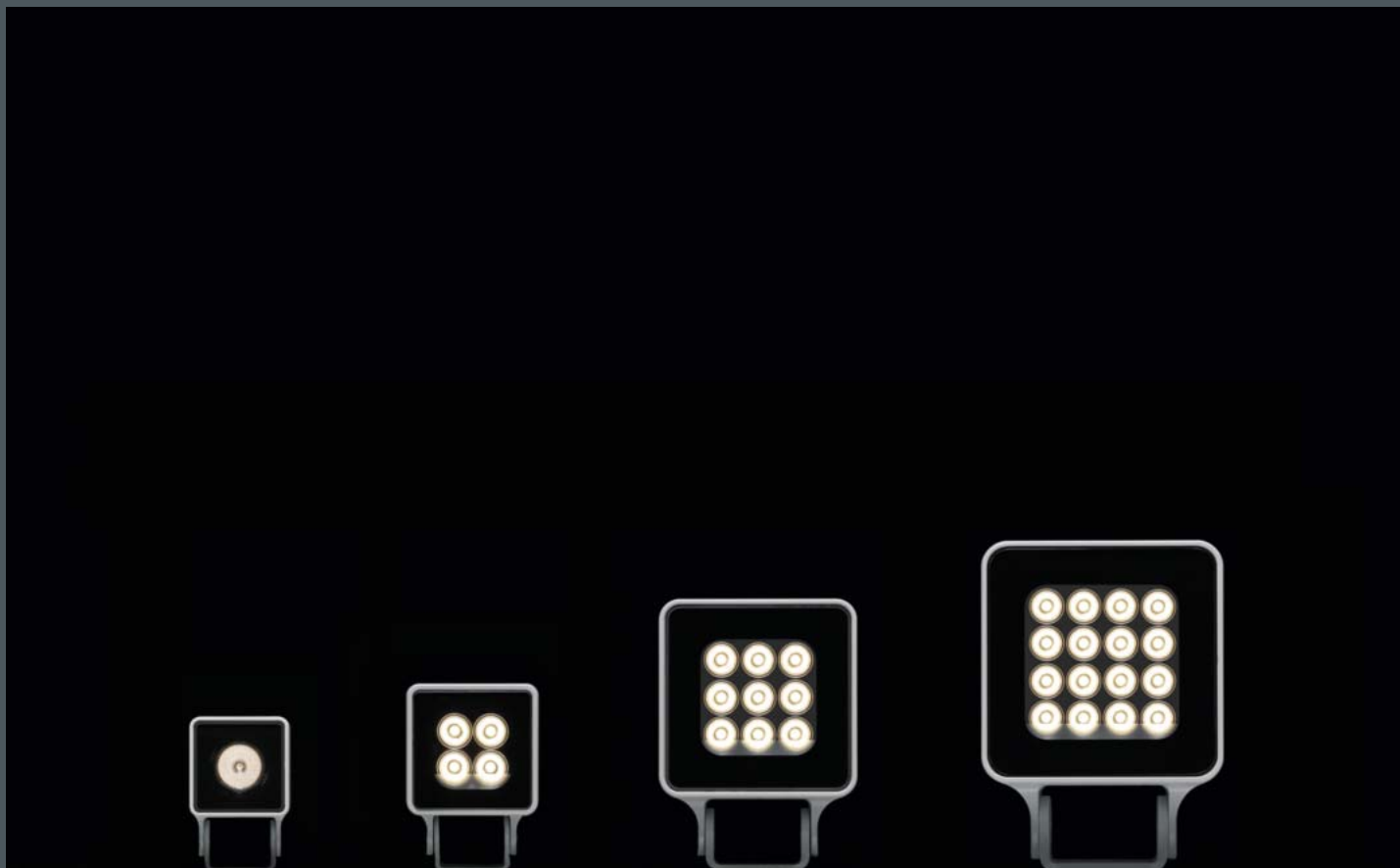

Monocube are floodlights with very compact dimensions and minimalist design that blend discretely into the architecture. The luminaire housings have a smooth surface and are therefore easy to clean and to maintain. With a choice of various different light distributions, they are flexible tools for architectural lighting – especially on façades. Monocube floodlights feature integral LED drivers and can be easily connected to mains voltage power supply.

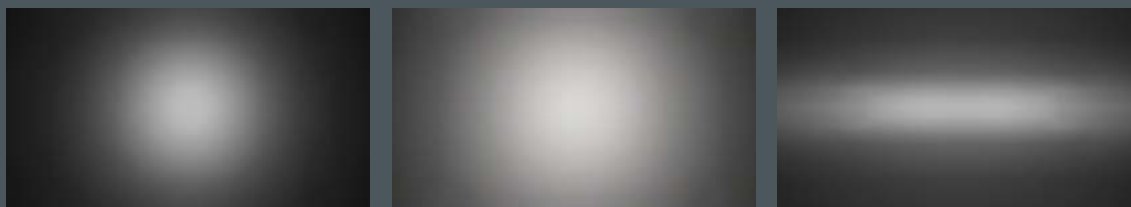

Optical film is available as an accessory in order to adapt the light distributions to the exact requirements of a lighting project. Samples can be tested and specified during mock-ups on site. Afterwards, this film will be factory fitted into the floodlights.



Nya Östermalmshallen, Stockholm
Lighting design: Light Bureau AFRY, Stockholm

Monocube feature very small dimensions and are installed unobtrusively.
The floodlights in sizes 3 and 4 can be equipped with CASAMBI®-App ready drivers and be dimmed via Bluetooth Low Energy technology without the necessity of a control wire.



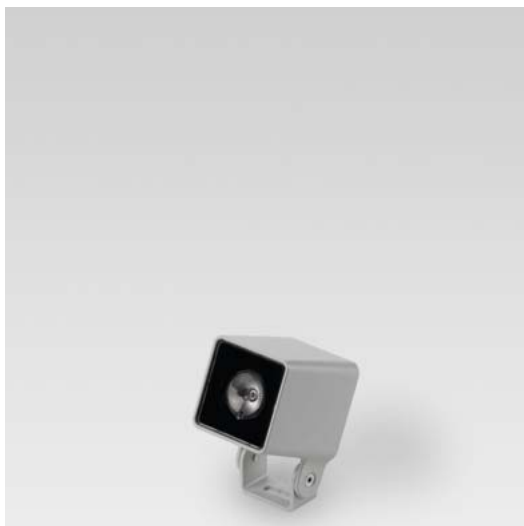
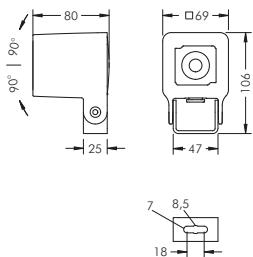

Monocube 1 with mounting bracket

With 1 x high performance LED, integral temperature monitoring device, CRI: > 80, Colour tolerance: max. 2 SDCM
 Service life: L90/B10 > 50 000 h
 protection class I, IP65 , IK08
 windage area AW 0.006 m²
 corrosion-resistant die cast aluminium housing AlSi12, polyester powder coated, precise PMMA optic, all exterior steel parts are stainless steel, tempered safety glass, silicon gasket, closure with 4 stainless steel screws, mounting bracket: 1 elongated hole Ø 7 mm, spacing 18 mm, 1 centre hole Ø 8.5 mm, tilt range 180°, M16 cable gland, integral driver (AC/DC)

Monocube 1, narrow beam

Part number*	Colour	Weight	Light source	Luminous flux	Beam angle γ (FWHM)
8 261 046 019	black	0.6 kg	1 x LED 3 W warm white (3000 K)	148 lm	4°
8 261 066 019	white				
8 261 056 019	silver grey				

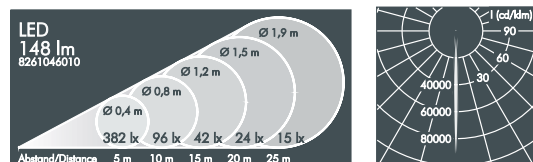

Part number*	Colour	Weight	Light source	Luminous flux	Beam angle γ (FWHM)
8 261 045 019	black	0.6 kg	1 x LED 3 W neutral white (4000 K)	156 lm	4°
8 261 065 019	white				
8 261 055 019	silver grey				

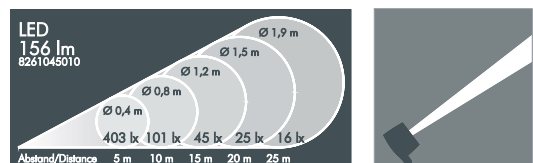

Monocube 1, linear beam spread, vertical

Part number*	Colour	Weight	Light source	Luminous flux	Beam angle γ (FWHM)	
8 261 046 029	black	0.6 kg	1 x LED 3 W warm white (3000 K)	146 lm	C 0 – 180	C 90 – 270
8 261 066 029	white				37°	8°
8 261 056 029	silver grey					

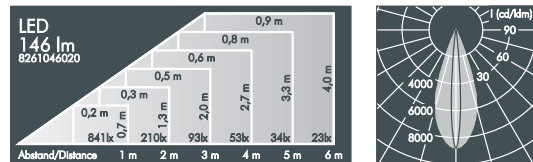

8 261 045 029	black	0.6 kg	1 x LED 3 W neutral white (4000 K)	153 lm	C 0 – 180	C 90 – 270
8 261 065 029	white				37°	8°
8 261 055 029	silver grey					

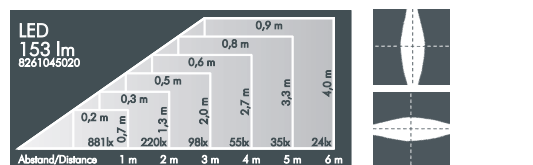

Part number*	Description
. 3.	Luminaire with linear beam spread, horizontal

Monocube 1, medium wide beam

Part number*	Colour	Weight	Light source	Luminous flux	Beam angle γ (FWHM)
8 261 046 049	black	0.6 kg	1 x LED 3 W warm white (3000 K)	127 lm	34°
8 261 066 049	white				
8 261 056 049	silver grey				

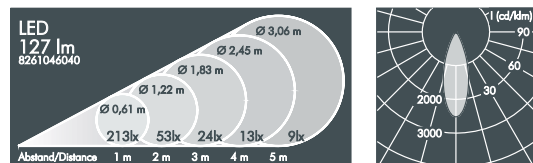

Monocube 1, wide beam

Part number*	Colour	Weight	Light source	Luminous flux	Beam angle γ (FWHM)
8 261 046 059	black	0.6 kg	1 x LED 3 W warm white (3000 K)	137 lm	55°
8 261 066 059	white				
8 261 056 059	silver grey				

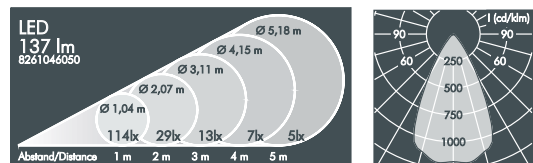

*Dimmable luminaires (DALI or 1-10 V) with external control gear unit and with further distribution options are available upon request.

LED

Luminaires available in 2700 K and other colour temperatures upon request



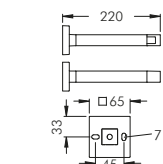

Accessories Monocube 1 external, **for retro-fitting**

Part number	Colour	Description
128 0 738 940	black	Wall arm 220 mm,
128 0 738 960	white	aluminium, polyester powder coated
128 0 738 950	silver grey	

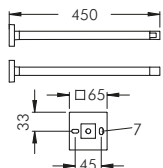

Part number	Colour	Description
128 0 739 940	black	Wall arm 450 mm,
128 0 739 960	white	aluminium, polyester powder coated
128 0 739 950	silver grey	

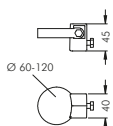

Part number	Colour	Description
128 0 760 940	black	Pole clamp, aluminium,
128 0 760 960	white	polyester powder coated, stainless steel strap,
128 0 760 950	silver grey	for mounting on poles Ø 60 - 120 mm

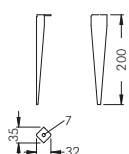

Part number	Colour	Description
123 0 470 940	black	Earth spike, stainless steel,
123 0 470 960	white	for use in landscaped areas
123 0 470 950	silver grey	

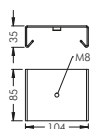

Part number	Description
120 0 661 940	Expandable tree strap with mounting plate, made of polyester fiber for trunk circumference max. 140 cm*, with polyester powder coated mounting plate

*different lengths available upon request

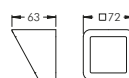

Part number	Colour	Description
122 0 521 940	black	Cowl, stainless steel,
122 0 521 960	white	to avoid glare from 3 directions,
122 0 521 950	silver grey	for retro-fitting



Accessories Monocube 1 internal, factory fitted	
Part number	Description
122 0 164 000	Honeycomb louvre to avoid glare



Part number	Description	Beam angle γ (FWHM)	
		narrow beam	medium wide beam
122 0 165 000	Diffuser film + for moderate light diffusion	8°	
122 0 166 000	Diffuser film ++ for medium light diffusion	14°	
122 0 167 000	Diffuser film +++ for strong light diffusion	24°	
		narrow beam	medium wide beam
122 0 168 000	Prismatic film for linear beam control, vertical	41° / 5°	42° / 21°
122 0 169 000	Prismatic film for linear beam control, horizontal	5° / 41°	21° / 42°

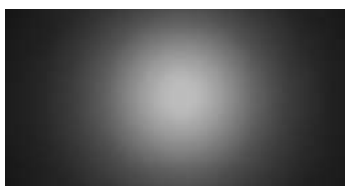

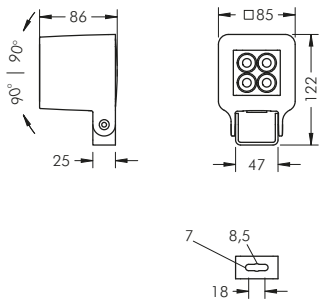

Monocube 2 with mounting bracket

With 4 x high performance LEDs, integral temperature monitoring device, CRI: > 80, Colour tolerance: max. 2 SDCM
 Service life: L90/B10 > 50 000 h
 protection class I, IP65 , IK08
 windage area AW 0.008 m²
 corrosion-resistant die cast aluminium housing AlSi12, polyester powder coated,
 precise PMMA optics,
 all exterior steel parts are stainless steel,
 tempered safety glass, silicon gasket,
 closure with 4 stainless steel screws,
 mounting bracket: 1 elongated hole Ø 7 mm, spacing 18 mm, 1 centre hole Ø 8.5 mm,
 tilt range 180°, M16 cable gland,
 integral driver (AC/DC)

Monocube 2, narrow beam

Part number*	Colour	Weight	Light source	Luminous flux	Beam angle γ (FWHM)
8 262 046 019	black	0.9 kg	4 x LED 1.7 W	599 lm	6°
8 262 066 019	white		(7 W)		
8 262 056 019	silver grey		warm white (3000 K)		

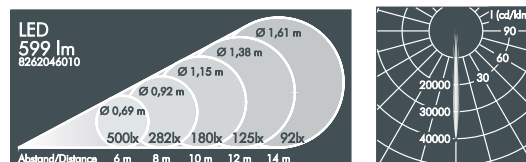

Part number*	Colour	Weight	Light source	Luminous flux	Beam angle γ (FWHM)
8 262 045 019	black	0.9 kg	4 x LED 1.7 W	629 lm	6°
8 262 065 019	white		(7 W)		
8 262 055 019	silver grey		neutral white (4000 K)		

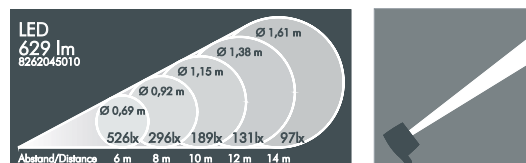

Monocube 2, linear beam spread, vertical

Part number*	Colour	Weight	Light source	Luminous flux	Beam angle γ (FWHM)
8 262 046 029	black	0.9 kg	4 x LED 1.7 W	516 lm	C 0 – 180 / C 90 – 270
8 262 066 029	white		(7 W)		54° / 7°
8 262 056 029	silver grey		warm white (3000 K)		



8 262 045 029	black	0.9 kg	4 x LED 1.7 W	542 lm	C 0 – 180 / C 90 – 270
8 262 065 029	white		(7 W)		54° / 7°
8 262 055 029	silver grey		neutral white (4000 K)		

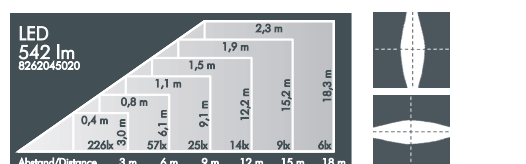

Part number*	Description
. 3.	Luminaire with linear beam spread, horizontal

Monocube 2, medium wide beam

Part number*	Colour	Weight	Light source	Luminous flux	Beam angle γ (FWHM)
8 262 046 049	black	0.9 kg	4 x LED 1.7 W	549 lm	25°
8 262 066 049	white		(7 W)		
8 262 056 049	silver grey		warm white (3000 K)		

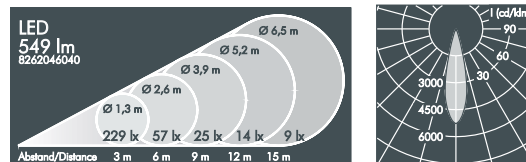

Monocube 2, wide beam

Part number*	Colour	Weight	Light source	Luminous flux	Beam angle γ (FWHM)
8 262 046 059	black	0.9 kg	4 x LED 1.7 W	464 lm	44°
8 262 066 059	white		(7 W)		
8 262 056 059	silver grey		warm white (3000 K)		

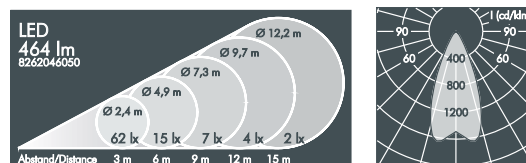

Part number*	Description	Light source
. 1..	Dimmable luminaire (DALI)	4 x LED 1 W (4 W)

*Luminaires available with other light distributions upon request

LED
 Luminaires available in 2700 K and other colour temperatures upon request



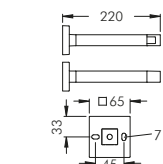

Accessories Monocube 2 external, **for retro-fitting**

Part number	Colour	Description
128 0 738 940	black	Wall arm 220 mm,
128 0 738 960	white	aluminium, polyester powder coated
128 0 738 950	silver grey	

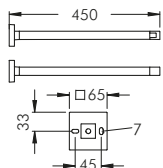

Part number	Colour	Description
128 0 739 940	black	Wall arm 450 mm,
128 0 739 960	white	aluminium, polyester powder coated
128 0 739 950	silver grey	

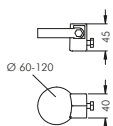

Part number	Colour	Description
128 0 760 940	black	Pole clamp, aluminium,
128 0 760 960	white	polyester powder coated, stainless steel strap,
128 0 760 950	silver grey	for mounting on poles Ø 60 - 120 mm

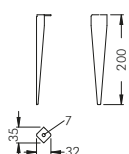

Part number	Colour	Description
123 0 470 940	black	Earth spike, stainless steel,
123 0 470 960	white	for use in landscaped areas
123 0 470 950	silver grey	

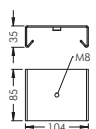

Part number	Description
120 0 661 940	Expandable tree strap with mounting plate, made of polyester fiber for trunk circumference max. 140 cm*, with polyester powder coated mounting plate

*different lengths available upon request

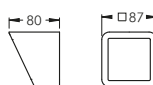

Part number	Colour	Description
122 0 522 940	black	Cowl, stainless steel,
122 0 522 960	white	to avoid glare from 3 directions,
122 0 522 950	silver grey	for retro-fitting

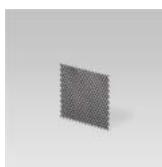

Accessories Monocube 2 internal, **factory fitted**

Part number	Description
238 0 205 000	Honeycomb louvre to avoid glare

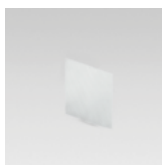

Part number	Description	Beam angle γ (FWHM)	
		narrow beam	medium wide beam
122 0 170 000	Diffuser film + for moderate light diffusion	10°	
122 0 171 000	Diffuser film ++ for medium light diffusion	16°	
122 0 172 000	Diffuser film +++ for strong light diffusion	26°	
122 0 173 000	Prismatic film for linear beam control, vertical	43° / 7°	44° / 23°
122 0 174 000	Prismatic film for linear beam control, horizontal	7° / 43°	23° / 44°

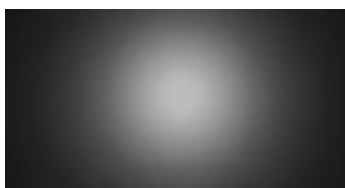

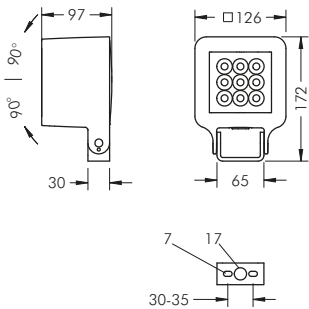

Monocube 3 with mounting bracket

With 9 x high performance LEDs, integral temperature monitoring device, CRI: > 80, Colour tolerance: max. 2 SDCM
 Service life: L90/B10 > 50 000 h
 protection class I, IP65 , IK08
 windage area AW 0.013 m²
 corrosion-resistant die cast aluminium housing AlSi12, polyester powder coated, precise PMMA optics, all exterior steel parts are stainless steel, tempered safety glass, silicon gasket, closure with 4 stainless steel screws, mounting bracket: 2 drilled holes Ø 7 mm, spacing 30 - 35 mm, 1 centre hole Ø 17 mm, tilt range 180°, M20 cable gland, integral driver (AC/DC)

Monocube 3, narrow beam

Part number*	Colour	Weight	Light source	Luminous flux	Beam angle γ (FWHM)
8 263 046 019	black	1.8 kg	9 x LED 2.5 W	1811 lm	6°
8 263 066 019	white		(23 W)		
8 263 056 019	silver grey		warm white (3000 K)		

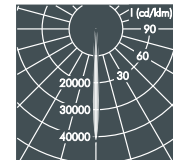
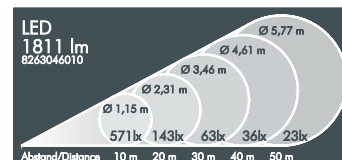

Part number*	Colour	Weight	Light source	Luminous flux	Beam angle γ (FWHM)
8 263 045 019	black	1.8 kg	9 x LED 2.5 W	1903 lm	6°
8 263 065 019	white		(23 W)		
8 263 055 019	silver grey		neutral white (4000 K)		

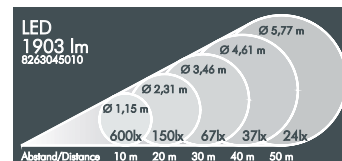

Monocube 3, linear beam spread, vertical

Part number*	Colour	Weight	Light source	Luminous flux	Beam angle γ (FWHM)	
8 263 046 029	black	1.8 kg	9 x LED 2.5 W	1624 lm	C 0 - 180	
8 263 066 029	white		(23 W)		54°	7°
8 263 056 029	silver grey		warm white (3000 K)			

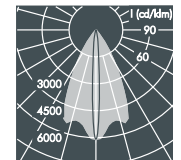
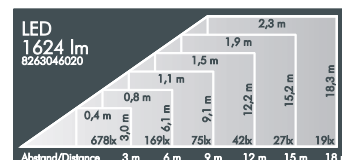

8 263 045 029	black	1.8 kg	9 x LED 2.5 W	1705 lm	C 0 - 180	
8 263 065 029	white		(23 W)		54°	7°
8 263 055 029	silver grey		neutral white (4000 K)			

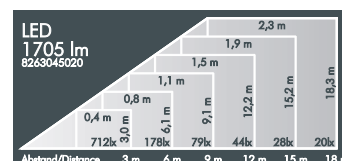

Part number*	Description
. 3.	Luminaire with linear beam spread, horizontal

Monocube 3, medium wide beam

Part number*	Colour	Weight	Light source	Luminous flux	Beam angle γ (FWHM)
8 263 046 049	black	1.8 kg	9 x LED 2.5 W	1729 lm	25°
8 263 066 049	white		(23 W)		
8 263 056 049	silver grey		warm white (3000 K)		

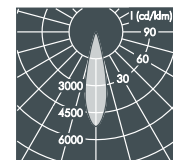
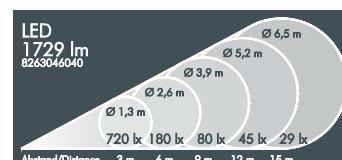

Monocube 3, wide beam

Part number*	Colour	Weight	Light source	Luminous flux	Beam angle γ (FWHM)
8 263 046 059	black	1.8 kg	9 x LED 2.5 W	1460 lm	44°
8 263 066 059	white		(23 W)		
8 263 056 059	silver grey		warm white (3000 K)		

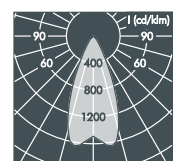
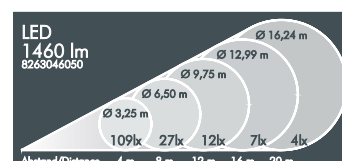

Part number*	Description
. . . . 2.	Pole luminaire, tilt range 90°, swivel range 360°
. 1.	Dimmable luminaire (DALI)
. 3.	Dimmable luminaire (CASAMBI®-App)
. 4.	Luminaire with 2 cable glands for through wiring

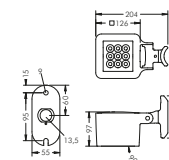

*Luminaires available with other light distributions upon request

LED
 Luminaires available in 2700 K and other colour temperatures upon request



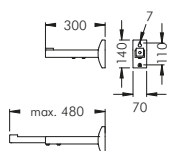

Accessories Monocube 3 external, **for retro-fitting**

Part number	Colour	Description
128 0 700 940	black	Telescopic wall arm 300 - 480 mm,
128 0 700 960	white	aluminium, polyester powder coated
128 0 700 950	silver grey	

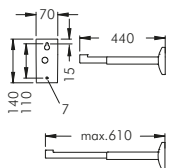

Part number	Colour	Description
128 0 730 940	black	Telescopic wall arm 440 - 610 mm,
128 0 730 960	white	aluminium, polyester powder coated
128 0 730 950	silver grey	

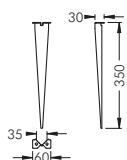

Part number	Colour	Description
122 0 512 940	black	Earth spike, stainless steel,
122 0 512 960	white	for use in landscaped areas
122 0 512 950	silver grey	

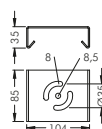

Part number	Description
120 0 664 940	Expandable tree strap with mounting plate,
	made of polyester fiber for trunk circumference max. 140 cm*,
	with polyester powder coated mounting plate

*different lengths available upon request

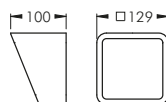

Part number	Colour	Description
122 0 523 940	black	Cowl, stainless steel,
122 0 523 960	white	to avoid glare from 3 directions,
122 0 523 950	silver grey	for retro-fitting

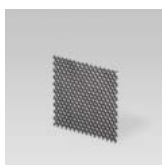
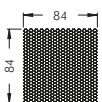

Accessories Monocube 3 internal, **factory fitted**

Part number	Description
238 0 206 000	Honeycomb louvre to avoid glare

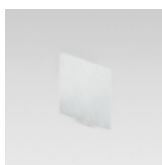
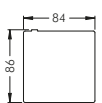

Part number	Description	Beam angle γ (FWHM)	
		narrow beam	medium wide beam
		narrow beam	
122 0 176 000	Diffuser film + for moderate light diffusion	10°	
122 0 177 000	Diffuser film ++ for medium light diffusion	16°	
122 0 178 000	Diffuser film +++ for strong light diffusion	26°	
		narrow beam	medium wide beam
122 0 179 000	Prismatic film for linear beam control, vertical	43° / 7°	44° / 23°
122 0 180 000	Prismatic film for linear beam control, horizontal	7° / 43°	23° / 44°

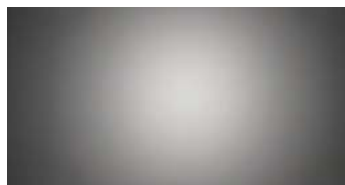

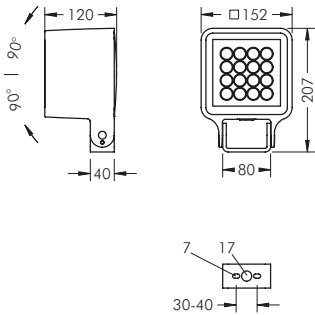

Monocube 4 with mounting bracket

With 16 x high performance LEDs, integral temperature monitoring device, CRI: > 80, Colour tolerance: max. 2 SDCM
 Service life: L90/B10 > 50 000 h
 protection class I, IP65 IK08
 windage area AW 0.02 m²
 corrosion-resistant die cast aluminium housing AlSi12, polyester powder coated, precise PMMA optics, all exterior steel parts are stainless steel, tempered safety glass, silicon gasket, closure with 4 stainless steel screws, mounting bracket: 2 drilled holes Ø 7 mm, spacing 30 - 40 mm, 1 centre hole Ø 17 mm, tilt range 180°, M20 cable gland, integral driver (AC/DC)

Monocube 4, narrow beam

Part number*	Colour	Weight	Light source	Luminous flux	Beam angle γ (FWHM)
8 264 046 019	black	2.4 kg	16 x LED 2.3 W	3086 lm	6°
8 264 066 019	white		(37 W)		
8 264 056 019	silver grey		warm white (3000 K)		

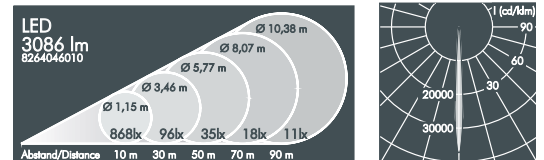

Part number*	Colour	Weight	Light source	Luminous flux	Beam angle γ (FWHM)
8 264 045 019	black	2.4 kg	16 x LED 2.3 W	3241 lm	6°
8 264 065 019	white		(37 W)		
8 264 055 019	silver grey		neutral white (4000 K)		

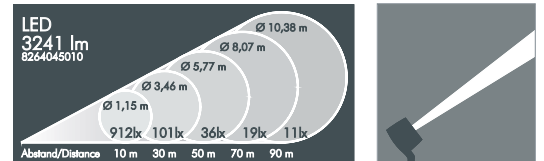

Monocube 4, linear beam spread, vertical

Part number*	Colour	Weight	Light source	Luminous flux	Beam angle γ (FWHM)	
8 264 046 029	black	2.4 kg	16 x LED 2.3 W	2762 lm	C 0 - 180	C 90 - 270
8 264 066 029	white		(37 W)		54°	7°
8 264 056 029	silver grey		warm white (3000 K)			



8 264 045 029	black	2.4 kg	16 x LED 2.3 W	2901 lm	C 0 - 180	C 90 - 270
8 264 065 029	white		(37 W)		54°	7°
8 264 055 029	silver grey		neutral white (4000 K)			



Part number*	Description
. 3.	Luminaire with linear beam spread, horizontal

Monocube 4, medium wide beam

Part number*	Colour	Weight	Light source	Luminous flux	Beam angle γ (FWHM)
8 264 046 049	black	2.4 kg	16 x LED 2.3 W	2954 lm	25°
8 264 066 049	white		(37 W)		
8 264 056 049	silver grey		warm white (3000 K)		

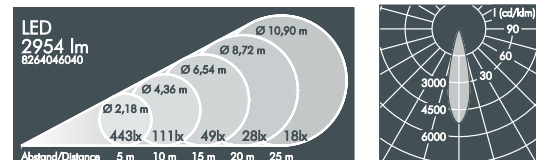

Monocube 4, wide beam

Part number*	Colour	Weight	Light source	Luminous flux	Beam angle γ (FWHM)
8 264 046 059	black	2.4 kg	16 x LED 2.3 W	2528 lm	44°
8 264 066 059	white		(37 W)		
8 264 056 059	silver grey		warm white (3000 K)		

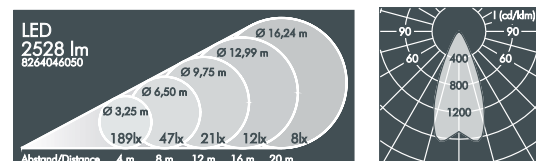

Part number*	Description
. . . 2. . . .	Pole luminaire , tilt range 90°, swivel range 360°
. 1.	Dimmable luminaire (DALI)
. 3.	Dimmable luminaire (CASAMBI®-App)
. 4.	Luminaire with 2 cable glands for through wiring

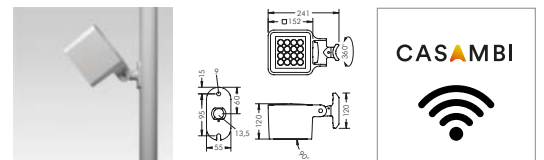

*Luminaires available with other light distributions upon request

LED
 Luminaires available in 2700 K and other colour temperatures upon request



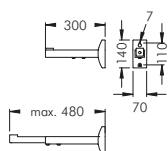

Accessories Monocube 4 external, **for retro-fitting**

Part number	Colour	Description
128 0 700 940	black	Telescopic wall arm 300 - 480 mm,
128 0 700 960	white	aluminium, polyester powder coated
128 0 700 950	silver grey	

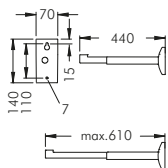

Part number	Colour	Description
128 0 730 940	black	Telescopic wall arm 440 - 610 mm,
128 0 730 960	white	aluminium, polyester powder coated
128 0 730 950	silver grey	

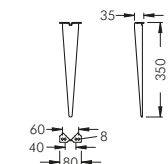

Part number	Colour	Description
129 0 736 940	black	Earth spike, stainless steel,
129 0 736 960	white	for use in landscaped areas
129 0 736 950	silver grey	

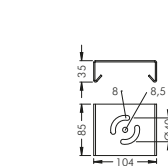

Part number	Description
120 0 620 940	Expandable tree strap with mounting plate, made of polyester fiber for trunk circumference max. 140 cm*, with polyester powder coated mounting plate

*different lengths available upon request

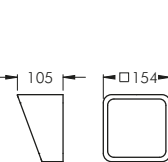

Part number	Colour	Description
122 0 524 940	black	Cowl, stainless steel,
122 0 524 960	white	to avoid glare from 3 directions,
122 0 524 950	silver grey	for retro-fitting

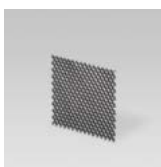
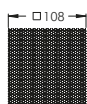

Accessories Monocube 4 internal, **factory fitted**

Part number	Description
232 0 599 000	Honeycomb louvre to avoid glare

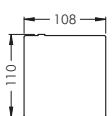

Part number	Description	Beam angle γ (FWHM)	
		narrow beam	medium wide beam
		narrow beam	
122 0 181 000	Diffuser film + for moderate light diffusion	10°	
122 0 182 000	Diffuser film ++ for medium light diffusion	16°	
122 0 183 000	Diffuser film +++ for strong light diffusion	26°	
		narrow beam	medium wide beam
122 0 184 000	Prismatic film for linear beam control, vertical	43° / 7°	44° / 23°
122 0 185 000	Prismatic film for linear beam control, horizontal	7° / 43°	23° / 44°



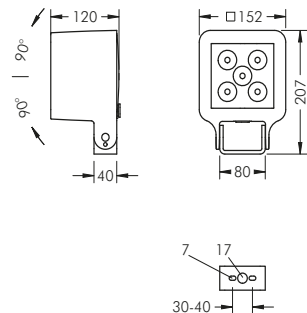

Monocube 4 RGBW with mounting bracket

With 5 x high performance LEDs RGBW, external DMX-controller required, integral temperature monitoring device, protection class I, IP65 , IK08 windage area AW 0.02 m² corrosion-resistant die cast aluminium housing AlSi12, polyester powder coated, precise PMMA optics, all exterior steel parts are stainless steel, tempered safety glass, silicon gasket, closure with 4 stainless steel screws, mounting bracket: 2 drilled holes Ø 7 mm, spacing 30 - 40 mm, 1 centre hole Ø 17 mm, tilt range 180°, 2 x M20 cable gland, RDM compatible integral driver (AC/DC)

Monocube 4 RGBW, narrow beam

Part number*	Colour	Weight	Light source	Luminous flux	Beam angle γ (FWHM)
8 264 049 019	black	2.8 kg	5 x LED RGBW W = 3000 K (max. 48 W)	max.	16°
8 264 069 019	white			1753 lm	
8 264 059 019	silver grey				

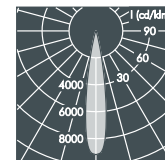

Monocube 4 RGBW, linear beam spread, vertical

Part number*	Colour	Weight	Light source	Luminous flux	Beam angle γ (FWHM)
8 264 049 029	black	2.8 kg	5 x LED RGBW W = 3000 K (max. 48 W)	max.	C 0 - 180
8 264 069 029	white			1753 lm	C 90 - 270
8 264 059 029	silver grey				33°

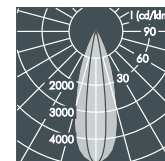

Monocube 4 RGBW, linear beam spread, horizontal

Part number*	Colour	Weight	Light source	Luminous flux	Beam angle γ (FWHM)
8 264 049 039	black	2.8 kg	5 x LED RGBW W = 3000 K (max. 48 W)	max.	C 0 - 180
8 264 069 039	white			1753 lm	C 90 - 270
8 264 059 039	silver grey				16°

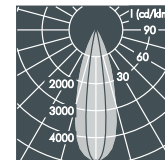
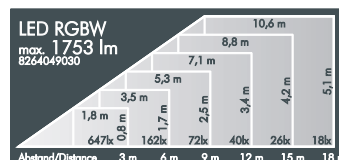

Monocube 4 RGBW, medium wide beam

Part number*	Colour	Weight	Light source	Luminous flux	Beam angle γ (FWHM)
8 264 049 049	black	2.8 kg	5 x LED RGBW W = 3000 K (max. 48 W)	max.	33°
8 264 069 049	white			1578 lm	
8 264 059 049	silver grey				

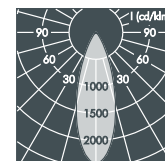
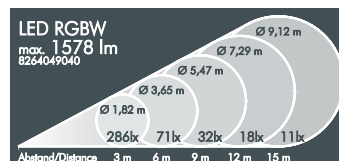

Monocube 4 RGBW, wide beam

Part number*	Colour	Weight	Light source	Luminous flux	Beam angle γ (FWHM)
8 264 049 059	black	2.8 kg	5 x LED RGBW W = 3000 K (max. 48 W)	max.	55°
8 264 069 059	white			1588 lm	
8 264 059 059	silver grey				

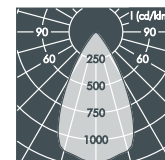
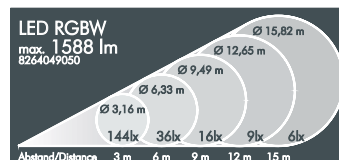

Part number*	Description
... 2... ..	Pole luminaire , tilt range 90°, swivel range 360°

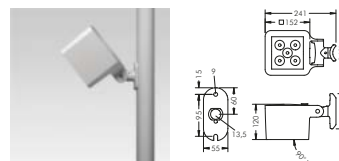

*The luminaires are available with LEDs in different colour combinations and Tunable White (2700 K - 6500 K) upon request.

LED



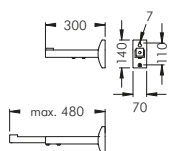

Accessories Monocube 4 external, **for retro-fitting**

Part number	Colour	Description
128 0 700 940	black	Telescopic wall arm 300 - 480 mm,
128 0 700 960	white	aluminium, polyester powder coated
128 0 700 950	silver grey	

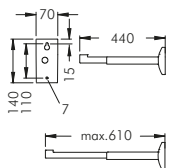

Part number	Colour	Description
128 0 730 940	black	Telescopic wall arm 440 - 610 mm,
128 0 730 960	white	aluminium, polyester powder coated
128 0 730 950	silver grey	

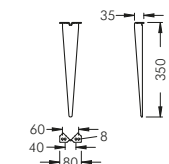

Part number	Colour	Description
129 0 736 940	black	Earth spike, stainless steel,
129 0 736 960	white	for use in landscaped areas
129 0 736 950	silver grey	

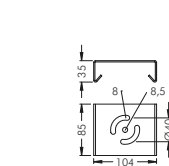

Part number	Description
120 0 620 940	Expandable tree strap with mounting plate, made of polyester fiber for trunk circumference max. 140 cm*, with polyester powder coated mounting plate

*different lengths available upon request

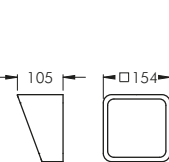

Part number	Colour	Description
122 0 524 940	black	Cowl, stainless steel,
122 0 524 960	white	to avoid glare from 3 directions,
122 0 524 950	silver grey	for retro-fitting

Accessories Monocube 4 internal, **factory fitted**

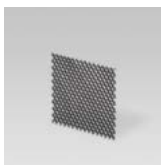
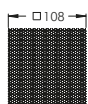

Part number	Description
232 0 599 000	Honeycomb louvre to avoid glare

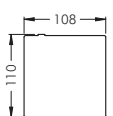

Part number	Description
122 0 181 000	Diffuser film + for moderate light diffusion
122 0 182 000	Diffuser film ++ for medium light diffusion
122 0 183 000	Diffuser film +++ for strong light diffusion
122 0 184 000	Prismatic film for linear beam control, vertical
122 0 185 000	Prismatic film for linear beam control, horizontal

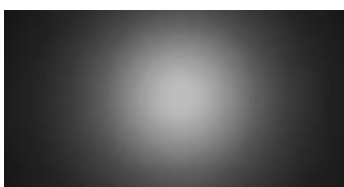



The Uplight S product range are luminaires with extremely shallow recess depth. This product feature ensures that the luminaires do not collide with existing infrastructure in the ground, such as electrical or water conduit. Adjustable collimator optics with various different light distributions make these products versatile tools for architectural and landscape lighting. Optimal glare control can be achieved by the use of honeycomb louvres as an accessory.

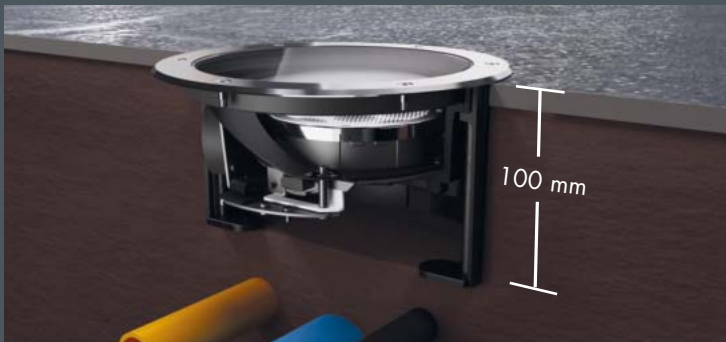

The small recess depth of the luminaires makes their installation unproblematic.



Hotel Maassluis, Netherlands
Lighting design: Livingprojects B.V., Breda

Uplight 180 S adjustable optics

With 5 x high performance LEDs,
 integral temperature monitoring device,
 CRI: > 80, Colour tolerance: max. 2 SDCM
 Service life: L90/B10 > 50 000 h
 protection class I, IP68 (1.5 m) \diamond \blacktriangledown \blacktriangledown , IK10
 corrosion-resistant cast aluminium housing AlSi12,
 double powder coated,
 precise PMMA optics,
 tilt range 0-15°, lockable,
 all exterior steel parts are stainless steel,
 tempered safety glass flush with frame,
 for loads up to max. 5000 kg (according to
 DIN EN 60598-2-13), silicon gasket,
 V4A stainless steel trim ring and δ screws,
 M20 cable gland with 0.8 m cable H07RN-F3G1,
 integral driver (AC/DC)

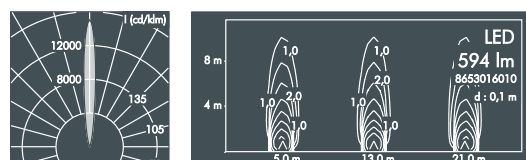
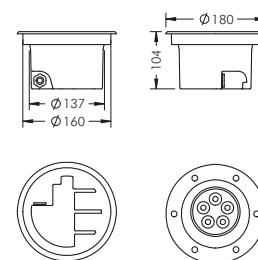

Uplight 180 S, adjustable optics, narrow beam

Part number	Weight	Light source	Luminous flux	Tilt range	Beam angle γ (FWHM)
8 653 016 019	2.3 kg	5 x LED 2 W (10 W) warm white (3000 K)	594 lm	0 - 15°	10°

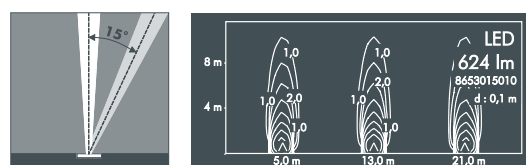

Part number	Weight	Light source	Luminous flux	Tilt range	Beam angle γ (FWHM)
8 653 015 019	2.3 kg	5 x LED 2 W (10 W) neutral white (4000 K)	624 lm	0 - 15°	10°

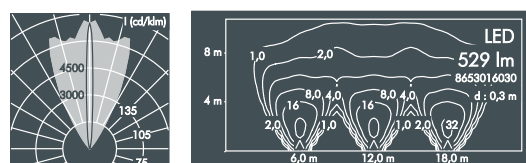

Uplight 180 S, adjustable optics, linear beam spread (horizontal)

Part number	Weight	Light source	Luminous flux	Tilt range	Beam angle γ (FWHM)	
					C 0 - 180	C 90 - 270
8 653 016 039	2.3 kg	5 x LED 2 W (10 W) warm white (3000 K)	529 lm	0 - 15°	6°	55°

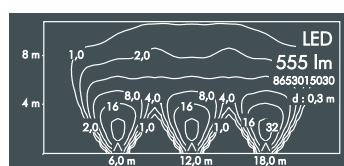

Part number	Weight	Light source	Luminous flux	Tilt range	Beam angle γ (FWHM)	
					C 0 - 180	C 90 - 270
8 653 015 039	2.3 kg	5 x LED 2 W (10 W) neutral white (4000 K)	555 lm	0 - 15°	6°	55°

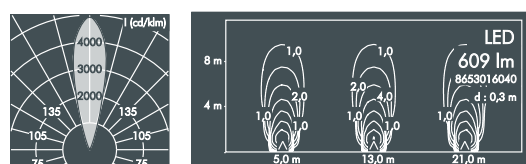

Uplight 180 S, adjustable optics, medium wide beam

Part number	Weight	Light source	Luminous flux	Tilt range	Beam angle γ (FWHM)
8 653 016 049	2.3 kg	5 x LED 2 W (10 W) warm white (3000 K)	609 lm	0 - 15°	26°

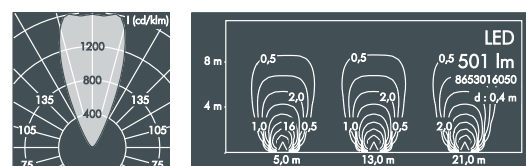

Uplight 180 S, adjustable optics, wide beam

Part number	Weight	Light source	Luminous flux	Tilt range	Beam angle γ (FWHM)
8 653 016 059	2.3 kg	5 x LED 2 W (10 W) warm white (3000 K)	501 lm	0 - 15°	46°

Part number	Description
... 1... ..	Luminaire with slip resistant glass (R13 according to DIN EN 51130) The light distribution becomes more diffuse.
... ..5 ...	Luminaire with neutral white colour temperature (4000 K)
... .. 1..	Dimmable luminaire (DALI)
8 654	Luminaire for installation flush with surrounding surface (in combination with installation sleeve 126 0 390 060)

LED

Luminaires available in 2700 K and other colour temperatures upon request



Accessories see page 27

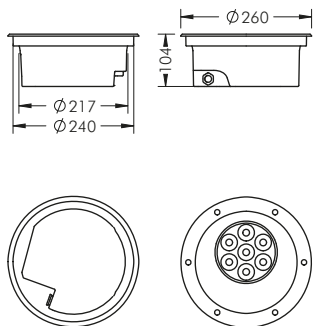

Uplight 260 S adjustable optics

With 7 x high performance LEDs, integral temperature monitoring device, CRI: > 80, Colour tolerance: max. 2 SDCM
 Service life: L90/B10 > 50 000 h
 protection class I, IP68 (1.5 m) ♦ ♦ ♦, IK10
 corrosion-resistant cast aluminium housing AlSi12, double powder coated,
 precise PMMA optics,
 tilt range 0-15°, lockable,
 all exterior steel parts are stainless steel, tempered safety glass flush with frame, for loads up to max. 4500 kg (according to DIN EN 60598-2-13), silicon gasket, V4A stainless steel trim ring and 6 screws, M20 cable gland with 0.8 m cable H07RN-F3G1, integral driver

Uplight 260 S, adjustable optics, narrow beam

Part number	Weight	Light source	Luminous flux	Tilt range	Beam angle γ (FWHM)
8 669 016 019	4.8 kg	7 x LED 3.5 W (25 W) warm white (3000 K)	2002 lm	0 – 15°	10°

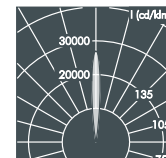

Part number	Weight	Light source	Luminous flux	Tilt range	Beam angle γ (FWHM)
8 669 015 019	4.8 kg	7 x LED 3.5 W (25 W) neutral white (4000 K)	2102 lm	0 – 15°	10°

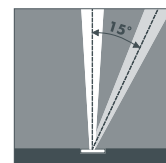
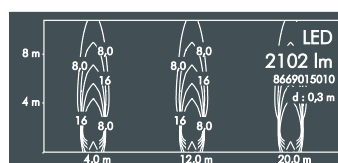

Uplight 260 S, adjustable optics, medium wide beam

Part number	Weight	Light source	Luminous flux	Tilt range	Beam angle γ (FWHM)
8 669 016 049	4.8 kg	7 x LED 3.5 W (25 W) warm white (3000 K)	1921 lm	0 – 15°	32°

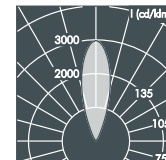
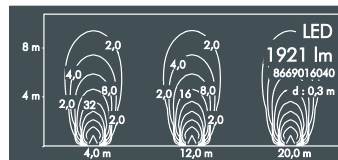

Part number	Weight	Light source	Luminous flux	Tilt range	Beam angle γ (FWHM)
8 669 015 049	4.8 kg	7 x LED 3.5 W (25 W) neutral white (4000 K)	2017 lm	0 – 15°	32°

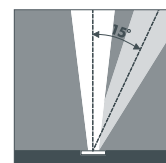

Uplight 260 S, adjustable optics, wide beam

Part number	Weight	Light source	Luminous flux	Tilt range	Beam angle γ (FWHM)
8 669 016 059	4.8 kg	7 x LED 3.5 W (25 W) warm white (3000 K)	2086 lm	0 – 15°	62°

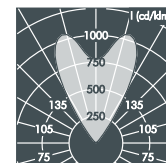
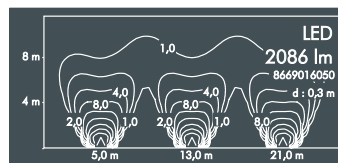

Part number	Weight	Light source	Luminous flux	Tilt range	Beam angle γ (FWHM)
8 669 015 059	4.8 kg	7 x LED 3.5 W (25 W) neutral white (4000 K)	2190 lm	0 – 15°	62°

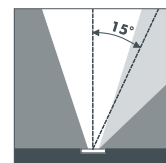
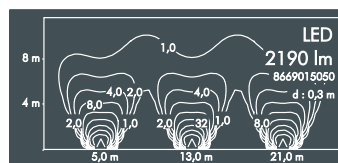

Part number	Description
. 1..	Dimmable luminaire (DALI)
. . . 1.. . . .	Luminaire with slip resistant glass (R13 according to DIN EN 51130) The light distribution becomes more diffuse.
8 670	Luminaire for installation flush with surrounding surface (in combination with installation sleeve 126 0 391 060)

Accessories see page 27

LED

Luminaires available in 2700 K and other colour temperatures upon request



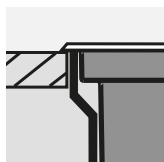
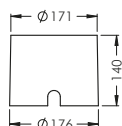

Accessories Uplight 180 S

Part number	Description
126 0 390 000	Installation sleeve , polypropylene, for luminaire with overlapping trim (for luminaires 8 653)

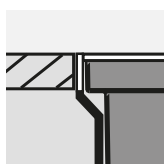
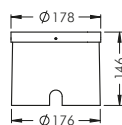

Part number	Description
126 0 390 060	Installation sleeve , polypropylene, for luminaire with trim for flush mounting (for luminaires 8 654)



Part number	Description
126 0 468 000	Honeycomb louvre* , internal, factory fitted, to avoid glare

* for retro-fitting, only one accessory per luminaire, not in combination

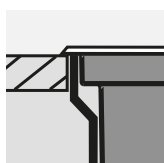
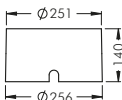

Accessories Uplight 260 S

Part number	Description
126 0 391 000	Installation sleeve , polypropylene, for luminaire with overlapping trim (for luminaires 8 669)

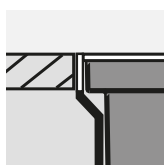
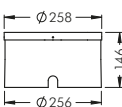

Part number	Description
126 0 391 060	Installation sleeve , polypropylene, for luminaire with trim for flush mounting (for luminaires 8 670)



Part number	Description
126 0 470 000	Honeycomb louvre* , internal, factory fitted, to avoid glare

* for retro-fitting, only one accessory per luminaire, not in combination

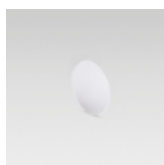

Uplight 260 S, narrow beam		Half beam angle γ	
Part number	Description	C 0-180	C 90-270
126 0 474 000	Ribbed glass spreader lense* , for linear beam control, continuously adjustable through 360°	10°	57°

* for retro-fitting, only one accessory per luminaire, not in combination



The ground-recessed luminaire Uplight 250 is equipped with the newly developed Tight Lock mechanism. This allows the orientation of the reflector to be changed without having to open the luminaire housing. With this innovation the risk of water ingress during the installation of the luminaire is eliminated. The stainless steel trim blends harmoniously with the flooring. In addition, precise reflectors feature excellent glare control.



In order to tilt the reflector, the outer trim is removed temporarily and an adjusting bolt is turned with a wrench. The luminaire housing remains closed and watertight during this adjustment.



Bundeskunsthalle Bonn, Paul Schmits

Uplight 250 with Tight Lock, externally adjustable optics

With high performance LED module (Zhaga),
 integral temperature monitoring device,
 CRI: > 80, Colour tolerance: 3 SDCM
 Service life: L80/B10 > 50 000 h
 Protection class I, IP67 \blacklozenge \blacktriangle \blacktriangledown , IK10
 corrosion-resistant cast aluminium housing AlSi 12,
 double powder coated,
 with polypropylene installation sleeve,
 highly efficient aluminium reflector,
 externally adjustable reflector system,
 tilt range 0-20°,
 with Heatslide mechanism for optimal heat dissipation,
 all exterior steel parts are stainless steel,
 tempered safety glass, for loads up to max. 4500 kg
 (according to DIN EN 60598-2-13),
 silicon gasket,
 V4A stainless steel trim ring closure with 2 screws,
 M20 cable gland, with 0.8 m cable H07RN-F3G1,
 integral driver (AC)

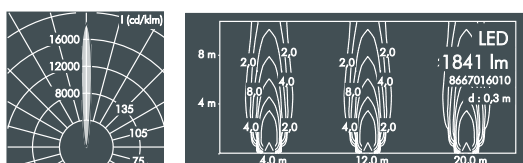
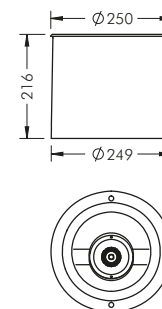

Uplight 250, narrow beam, with Tight Lock, externally adjustable optics

Part number	Weight	Light source	Luminous flux	Tilt range	Beam angle γ (FWHM)
8 667 016 019	5.4 kg	1 x LED module 18 W warm white (3000 K)	1841 lm	0 - 20°	9°

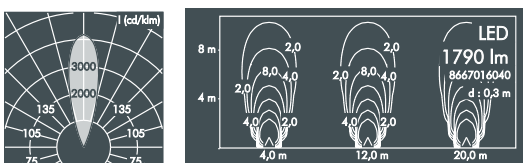

Uplight 250, medium wide beam, with Tight Lock, externally adjustable optics

Part number	Weight	Light source	Luminous flux	Tilt range	Beam angle γ (FWHM)
8 667 016 049	5.4 kg	1 x LED module 18 W warm white (3000 K)	1790 lm	0 - 20°	28°

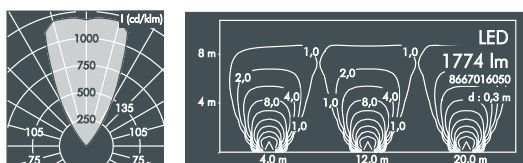

Uplight 250, wide beam, with Tight Lock, externally adjustable optics

Part number	Weight	Light source	Luminous flux	Tilt range	Beam angle γ (FWHM)
8 667 016 059	5.4 kg	1 x LED module 18 W warm white (3000 K)	1774 lm	0 - 20°	55°

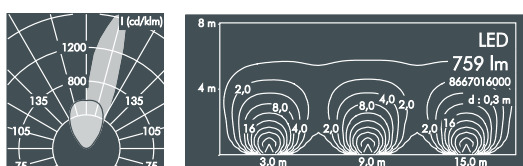

Uplight 250, wall washer, with Tight Lock, externally adjustable optics

Part number	Weight	Light source	Luminous flux	Tilt range	Beam angle γ (FWHM)
8 667 016 009	5.4 kg	1 x LED module 18 W warm white (3000 K)	759 lm	0 - 20°	C 0 - 180 25° C 90 - 270 75°

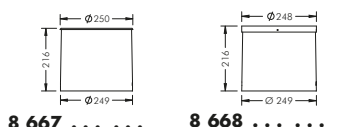

overlapping trim ring trim ring for flush mounting

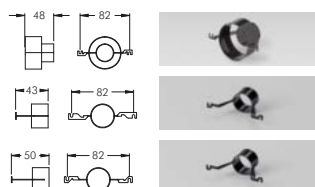

Part number	Description
... 1 ...	Luminaire with slip resistant glass (R13 according to DIN EN 51130) The light distribution becomes more diffuse.
... 5 ...	Luminaire with neutral white colour temperature (4000 K)
... 1 ...	Dimmable luminaire (DALI)
8 668 ...	Luminaire for installation flush with surrounding surface

Accessories Uplight 250, with Tight Lock, externally adjustable optics

Part number	Light distribution	Description
126 0 471 940	narrow beam	Radial louvre,
126 0 472 940	medium wide beam	internal (factory fitted),
126 0 473 940	wide beam	to reduce lateral glare

LED

Luminaires available in 2700 K and other colour temperatures upon request





The exemplary floodlight series Monospot is extended by new versions with very shallow housings. Monospot S brings minimalist design to the next level and the luminaires can be integrated even more easily into the architecture. With compact dimensions and precise optics the floodlights are used for accent lighting on façades or to illuminate objects from a long distance. They are available in 4 different sizes and wattages.



Viaduc SNCF Lyon Perrache
Lighting design:
Direction de l'Éclairage Public de la Ville de Lyon
Photo: Michel Djaoui

Monospot S pole luminaires are available with a tilt-and-turn fixing system. The combination of floodlights with different optics makes creative lighting scenarios possible. The neutral design blends harmoniously into the urban environment or landscape architecture.



Monospot S features an innovative indirect reflector system for wide beam light distribution. The light of LEDs, which are completely shielded, is directed via precise reflectors. Perfect glare control and high efficiency are achieved simultaneously.

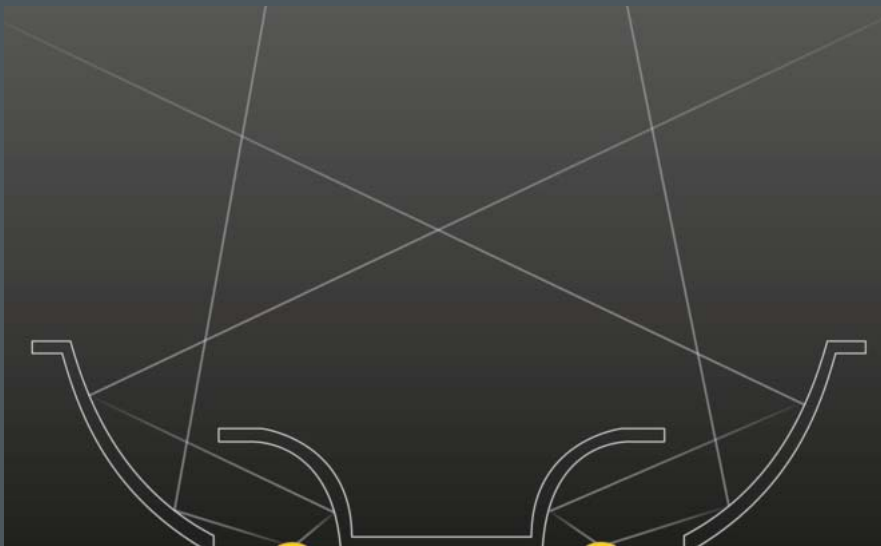

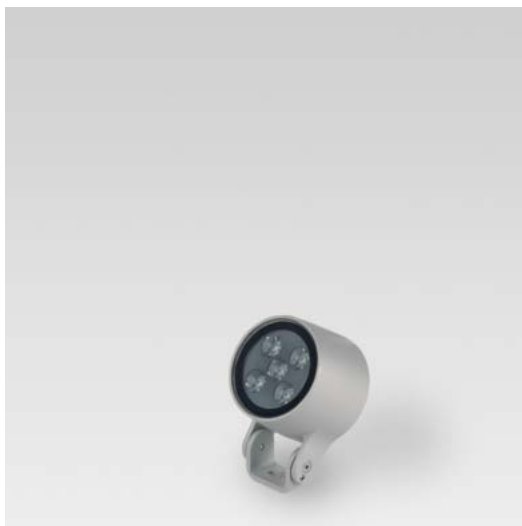
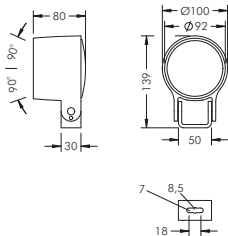

Monospot S1 with mounting bracket

With 5 x high performance LEDs, integral temperature monitoring device, CRI: > 80, Colour tolerance: max. 2 SDCM
 Service life: L90/B10 > 50 000 h
 protection class I, IP65 , IK08
 windage area AW 0.009 m²
 corrosion-resistant die cast aluminium housing AlSi12, polyester powder coated,
 precise PMMA optics,
 all exterior steel parts are stainless steel,
 tempered safety glass, silicon gasket,
 closure with 2 stainless steel screws,
 mounting bracket: 1 elongated hole Ø 7 mm, spacing 18 mm, 1 centre hole Ø 8.5 mm,
 tilt range 180°, M16 cable gland,
 integral driver (AC/DC)

Monospot S1, narrow beam

Part number	Colour	Weight	Light source	Luminous flux	Beam angle γ (FWHM)
8 991 046 019	black	0.9 kg	5 x LED 1.2 W (6 W) warm white (3000 K)	424 lm	6°
8 991 066 019	white				
8 991 056 019	silver grey				

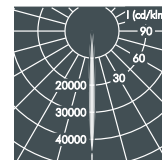
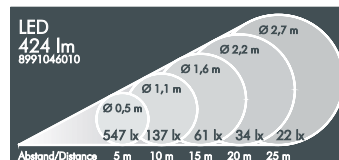

Part number	Colour	Weight	Light source	Luminous flux	Beam angle γ (FWHM)
8 991 045 019	black	0.9 kg	5 x LED 1.2 W (6 W) neutral white (4000 K)	446 lm	6°
8 991 065 019	white				
8 991 055 019	silver grey				

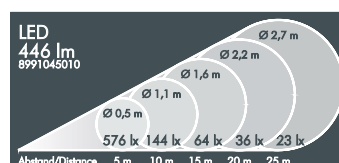

Monospot S1, linear beam spread, vertical

Part number	Colour	Weight	Light source	Luminous flux	Beam angle γ (FWHM)
8 991 046 029	black	0.9 kg	5 x LED 1.2 W (6 W) warm white (3000 K)	399 lm	C 0 – 180
8 991 066 029	white				55°
8 991 056 029	silver grey				7°

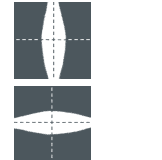
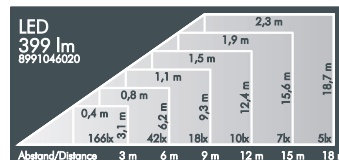

... .3. Luminaire with linear beam spread, horizontal

Monospot S1, medium wide beam

Part number	Colour	Weight	Light source	Luminous flux	Beam angle γ (FWHM)
8 991 046 049	black	0.9 kg	5 x LED 1.2 W (6 W) warm white (3000 K)	419 lm	24°
8 991 066 049	white				
8 991 056 049	silver grey				

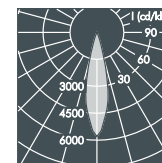
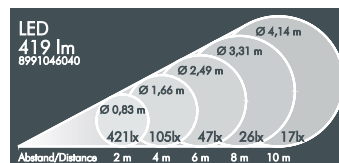

Part number	Colour	Weight	Light source	Luminous flux	Beam angle γ (FWHM)
8 991 045 049	black	0.9 kg	5 x LED 1.2 W (6 W) neutral white (4000 K)	440 lm	24°
8 991 065 049	white				
8 991 055 049	silver grey				

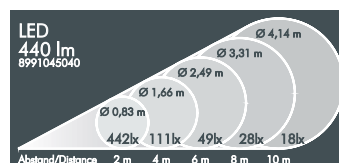

Monospot S1, wide beam

Part number	Colour	Weight	Light source	Luminous flux	Beam angle γ (FWHM)
8 991 046 059	black	0.9 kg	5 x LED 1.2 W (6 W) warm white (3000 K)	370 lm	46°
8 991 066 059	white				
8 991 056 059	silver grey				

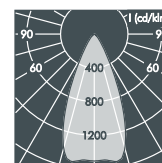
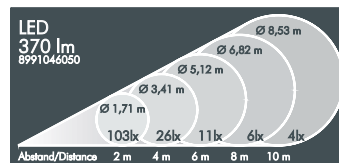

Part number	Colour	Weight	Light source	Luminous flux	Beam angle γ (FWHM)
8 991 045 059	black	0.9 kg	5 x LED 1.2 W (6 W) neutral white (4000 K)	389 lm	46°
8 991 065 059	white				
8 991 055 059	silver grey				

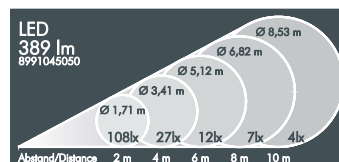

LED

Luminaires available in 2700 K and other colour temperatures upon request



Monospot S2 with mounting bracket

With 4 x high performance LEDs,
integral temperature monitoring device,
CRI: > 80, Colour tolerance: max. 2 SDCM
Service life: L90/B10 > 50 000 h
protection class I, IP65 , IK08
windage area AW 0.012 m²
corrosion-resistant die cast aluminium housing AlSi12,
polyester powder coated,
precise PMMA optics,
all exterior steel parts are stainless steel,
tempered safety glass, silicon gasket,
closure with 2 stainless steel screws,
mounting bracket: 1 elongated hole \varnothing 7 mm,
spacing 18 mm, 1 centre hole \varnothing 8.5 mm,
tilt range 180°, M16 cable gland,
integral driver (AC/DC)

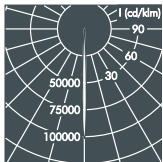
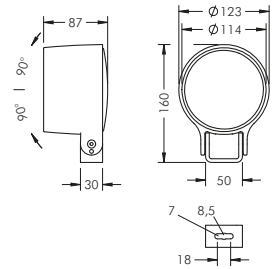

Abstand/Distance	5 m	10 m	15 m	20 m	25 m
Beam diameter	0,40 m	0,80 m	1,21 m	1,61 m	2,01 m
Luminous flux	1487lk	372lk	165lk	93lk	59lk



Abstand/Distance	5 m	10 m	15 m	20 m	25 m
Beam diameter	0,40 m	0,80 m	1,21 m	1,61 m	2,01 m
Luminous flux	1563lk	391lk	174lk	98lk	63lk

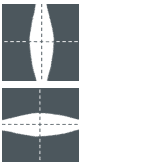

Abstand/Distance	3 m	6 m	9 m	12 m	15 m	18 m
Beam diameter	0,5 m	1,1 m	1,6 m	2,1 m	2,7 m	3,2 m
Luminous flux	271lk	2,0 lk	3,9 lk	5,5 lk	7,8 lk	9,2 lk
Luminous flux	68lk	30lk	17lk	11lk	8lk	

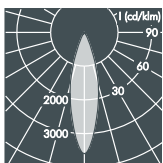

Abstand/Distance	3 m	6 m	9 m	12 m	15 m
Beam diameter	1,5 m	2,9 m	4,4 m	5,8 m	7,3 m
Luminous flux	133 lk	33 lk	15 lk	8 lk	5 lk

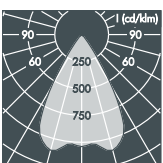

Abstand/Distance	2 m	4 m	6 m	8 m	10 m
Beam diameter	2,32 m	4,64 m	6,96 m	9,28 m	11,59 m
Luminous flux	107lk	27lk	12lk	7lk	4lk

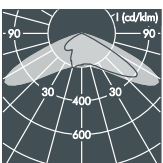

Abstand/Distance	4 m	8 m	10,0 m
Beam diameter	1,0 m	2,0 m	5,0 m
Luminous flux	2 LPH: 4,0 m		

Monospot S2, narrow beam

Part number	Colour	Weight	Light source	Luminous flux	Beam angle γ (FWHM)
8 992 046 019	black	1.2 kg	4 x LED 2.5 W (10 W)	502 lm	4°
8 992 066 019	white				
8 992 056 019	silver grey		warm white (3000 K)		

Part number	Colour	Weight	Light source	Luminous flux	Beam angle γ (FWHM)
8 992 045 019	black	1.2 kg	4 x LED 2.5 W (10 W)	528 lm	4°
8 992 065 019	white		neutral white (4000 K)		
8 992 055 019	silver grey				

Monospot S2, linear beam spread, vertical

Part number	Colour	Weight	Light source	Luminous flux	Beam angle γ (FWHM)
8 992 046 029	black	1.2 kg	4 x LED 2.5 W (10 W)	506 lm	C 0 - 180
8 992 066 029	white		warm white (3000 K)		C 90 - 270
8 992 056 029	silver grey				36°
					9°

. 3. Luminaire with linear beam spread, horizontal

Monospot S2, medium wide beam

Part number	Colour	Weight	Light source	Luminous flux	Beam angle γ (FWHM)
8 992 046 049	black	1.2 kg	4 x LED 2.5 W (10 W)	510 lm	27°
8 992 066 049	white				
8 992 056 049	silver grey		warm white (3000 K)		

Monospot S2, wide beam

Part number	Colour	Weight	Light source	Luminous flux	Beam angle γ (FWHM)
8 992 046 059	black	1.2 kg	4 x LED 2.5 W (10 W)	560 lm	60°
8 992 066 059	white				
8 992 056 059	silver grey		warm white (3000 K)		

Monospot S2, asymmetrical wide beam

Part number	Colour	Weight	Light source	Luminous flux	Main beam angle γ
8 992 046 089	black	1.2 kg	1 x LED 9 W	679 lm	C 0 - 180
8 992 066 089	white		warm white (3000 K)		C 90 - 270
8 992 056 089	silver grey				53°
					115°

Part number	Description
. 5 . . .	Luminaire with neutral white colour temperature (4000 K)
. 1 . .	Dimmable luminaire (DALI)

LED

Luminaires available in 2700 K and other colour temperatures upon request



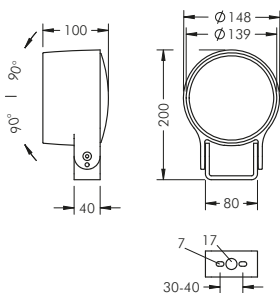

Monospot S3 with mounting bracket

With high performance LED or LED module Zhaga, integral temperature monitoring device, CRI: > 80, Colour tolerance: max. 2 SDCM Service life: L90/B10 > 50 000 h protection class I, IP65 , IK08 windage area AW 0.016 m² corrosion-resistant die cast aluminium housing AlSi12, polyester powder coated, precise PMMA optics, highly efficient aluminium indirect reflector or silicon optic, all exterior steel parts are stainless steel, tempered safety glass, silicon gasket, closure with 2 stainless steel screws, mounting bracket: 2 drilled holes Ø 7 mm, spacing 30 - 40 mm, 1 centre hole Ø 17 mm, tilt range 180°, M16 cable gland, integral driver (AC/DC)

Monospot S3, narrow beam

Part number	Colour	Weight	Light source	Luminous flux	Beam angle γ (FWHM) γ
8 993 046 019	black	1.8 kg	5 x LED 5.2 W (26 W) warm white (3000 K)	1791 lm	6°
8 993 066 019	white				
8 993 056 019	silver grey				

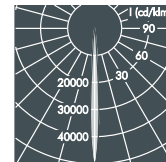
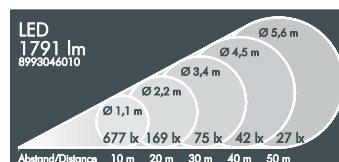

Monospot S3, linear beam spread, vertical

Part number	Colour	Weight	Light source	Luminous flux	Beam angle γ (FWHM)
8 993 046 029	black	1.8 kg	5 x LED 5.2 W (26 W) warm white (3000 K)	1744 lm	C 0 – 180
8 993 066 029	white				C 90 – 270
8 993 056 029	silver grey				36°

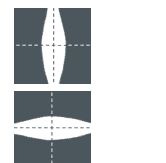
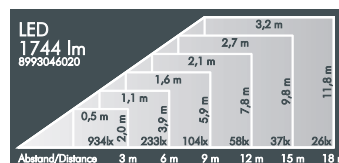

. 3. Luminaire with linear beam spread, horizontal

Monospot S3, linear beam spread, rotatable

Part number	Colour	Description	Luminous flux	Beam angle γ (FWHM)
8 993 046 079	black	Luminaire with external ribbed glass spreader lens, continuously adjustable through 360° from outside the luminaire	1433 lm	C 0 – 180
8 993 066 079	white			C 90 – 270
8 993 056 079	silver grey			6°

Weight 1.9 kg

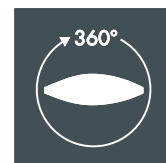

Monospot S3, medium wide beam

Part number	Colour	Weight	Light source	Luminous flux	Beam angle γ (FWHM)
8 993 046 049	black	1.8 kg	5 x LED 5.2 W (26 W) warm white (3000 K)	1592 lm	33°
8 993 066 049	white				
8 993 056 049	silver grey				

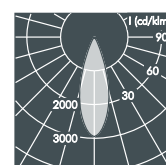
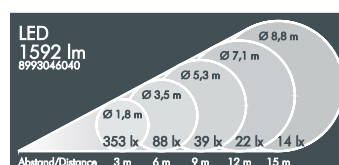

Monospot S3, wide beam (with indirect reflector)

Part number	Colour	Weight	Light source	Luminous flux	Beam angle γ (FWHM)
8 993 046 059	black	1.7 kg	1 x LED module 28 W warm white (3000 K)	2492 lm	78°
8 993 066 059	white				
8 993 056 059	silver grey				

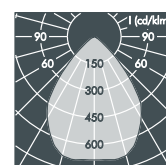
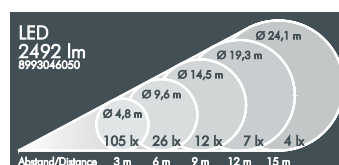

Monospot S3, Street Optic

Part number	Colour	Weight	Light source	Luminous flux	Beam angle γ (FWHM)
8 993 046 089	black	1.8 kg	1 x LED module 27 W warm white (3000 K)	2419 lm	C 0 – 180
8 993 066 089	white				C 90 – 270
8 993 056 089	silver grey				52°

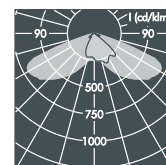
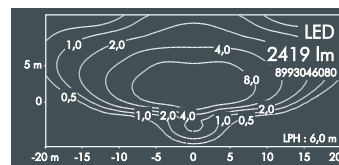

Part number	Description
. 5 . . .	Luminaire with neutral white colour temperature (4000 K)
. 1 . .	Dimmable luminaire (DALI)

LED

Luminaires available in 2700 K and other colour temperatures upon request



Monospot S3 pole luminaire

With high performance LED or LED module Zhaga, integral temperature monitoring device, CRI: > 80, Colour tolerance: max. 2 SDCM
 Service life: L90/B10 > 50 000 h
 protection class I, IP65 , IK08
 windage area AW 0.018 m²
 corrosion-resistant die cast aluminium housing AlSi12, polyester powder coated,
 precise PMMA optics, highly efficient aluminium indirect reflector or silicon optic,
 all exterior steel parts are stainless steel,
 tempered safety glass, silicon gasket,
 closure with 2 stainless steel screws,
 for installation on poles Ø 60 - 100 mm,
 tiltable base made of powder coated aluminium,
 2 drilled holes Ø 9 mm, spacing 95 mm,
 1 drilled hole Ø 13.5 mm, tilt range 90°
 swivel range 360°, M16 cable gland,
 integral driver (AC/DC)

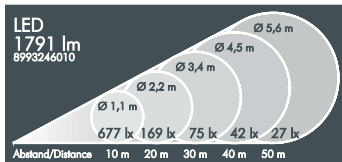
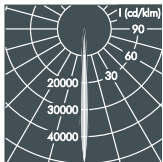
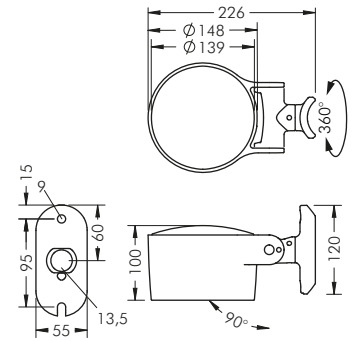

Monospot S3 pole luminaire, narrow beam

Part number	Colour	Weight	Light source	Luminous flux	Beam angle γ (FWHM)
8 993 246 019	black	2.0 kg	5 x LED 5.2 W	1791 lm	6°
8 993 266 019	white		(26 W)		
8 993 256 019	silver grey		warm white (3000 K)		

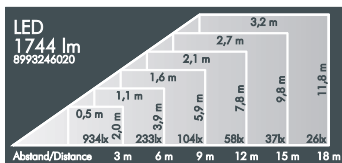

Monospot S3 pole luminaire, linear beam spread, vertical

Part number	Colour	Weight	Light source	Luminous flux	Beam angle γ (FWHM)
8 993 246 029	black	2.0 kg	5 x LED 5.2 W	1744 lm	C 0 - 180
8 993 266 029	white		(26 W)		C 90 - 270
8 993 256 029	silver grey		warm white (3000 K)		36°

... .3. Luminaire with linear beam spread, horizontal

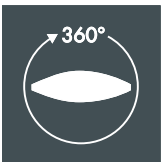

Monospot S3 pole luminaire, linear beam spread, rotatable

Part number	Colour	Description	Luminous flux	Beam angle γ (FWHM)
8 993 246 079	black	Luminaire with external ribbed glass spreader lens, continuously adjustable through 360° from outside the luminaire	1433 lm	C 0 - 180
8 993 266 079	white			C 90 - 270
8 993 256 079	silver grey			6°

Weight 2.1 kg

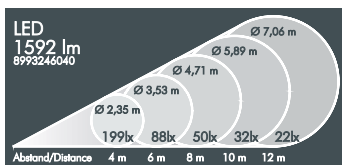
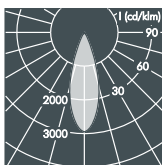

Monospot S3 pole luminaire, medium wide beam

Part number	Colour	Weight	Light source	Luminous flux	Beam angle γ (FWHM)
8 993 246 049	black	2.0 kg	5 x LED 5.2 W	1592 lm	33°
8 993 266 049	white		(26 W)		
8 993 256 049	silver grey		warm white (3000 K)		

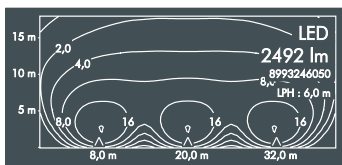
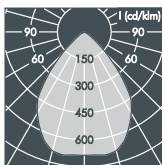

Monospot S3 pole luminaire, wide beam (with indirect reflector)

Part number	Colour	Weight	Light source	Luminous flux	Beam angle γ (FWHM)
8 993 246 059	black	1.9 kg	1 x LED module 28 W	2492 lm	78°
8 993 266 059	white				
8 993 256 059	silver grey				

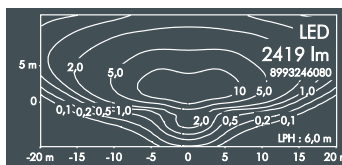
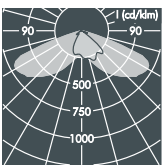

Monospot S3 pole luminaire, Street Optic

Part number	Colour	Weight	Light source	Luminous flux	Beam angle γ (FWHM)
8 993 246 089	black	2.0 kg	1 x LED module 27 W	2419 lm	C 0 - 180
8 993 266 089	white				C 90 - 270
8 993 256 089	silver grey				52°

Part number	Description
... .5 ...	Luminaire with neutral white colour temperature (4000 K)
... .1 ...	Dimmable luminaire (DALI)

LED

Luminaires available in 2700 K and other colour temperatures upon request



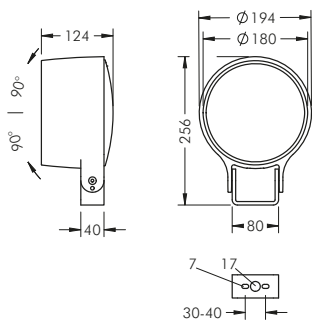

Monospot S4 with mounting bracket

With high performance LED or LED module Zhaga, integral temperature monitoring device, CRI: > 80, Colour tolerance: max. 2 SDCM Service life: L90/B10 > 50 000 h protection class I, IP65 , IK08 windage area AW 0.025 m² corrosion-resistant die cast aluminium housing AlSi12, polyester powder coated, precise PMMA optics, highly efficient aluminium indirect reflector or silicon optic, all exterior steel parts are stainless steel, tempered safety glass, silicon gasket, closure with 3 stainless steel screws, mounting bracket: 2 drilled holes Ø 7 mm, spacing 30 - 40 mm, 1 centre hole Ø 17 mm, tilt range 180°, M20 cable gland, integral driver (AC/DC) or integral RGBW driver (DMX - RDM)

Monospot S4, narrow beam

Part number	Colour	Weight	Light source	Luminous flux	Beam angle γ (FWHM)
8 994 046 019	black	3.0 kg	6 x LED 7.7 W (46 W)	2855 lm	5°
8 994 066 019	white				
8 994 056 019	silver grey				

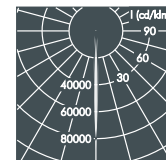
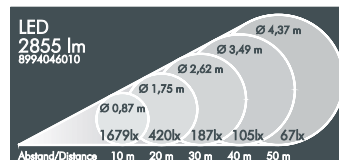

Monospot S4, linear beam spread, vertical

Part number	Colour	Weight	Light source	Luminous flux	Beam angle γ (FWHM)
8 994 046 029	black	3.0 kg	6 x LED 7.7 W (46 W)	2789 lm	C 0 – 180
8 994 066 029	white				40°
8 994 056 029	silver grey				8°

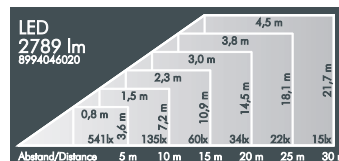

Monospot S4, medium wide beam

Part number	Colour	Weight	Light source	Luminous flux	Beam angle γ (FWHM)
8 994 046 049	black	3.0 kg	6 x LED 7.7 W (46 W)	2385 lm	35°
8 994 066 049	white				
8 994 056 049	silver grey				

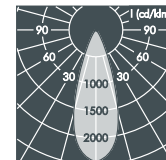
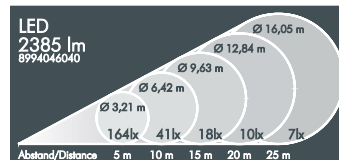

Monospot S4, wide beam (with indirect reflector)

Part number	Colour	Weight	Light source	Luminous flux	Beam angle γ (FWHM)
8 994 046 059	black	2.9 kg	1 x LED module 45 W warm white (3000 K)	3770 lm	92°
8 994 066 059	white				
8 994 056 059	silver grey				

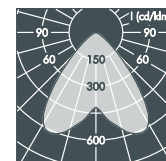
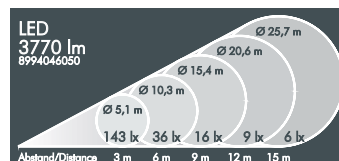

Monospot S4, Street Optic

Part number	Colour	Weight	Light source	Luminous flux	Beam angle γ (FWHM)
8 994 046 089	black	3.0 kg	1 x LED module 46 W warm white (3000 K)	4104 lm	C 0 – 180
8 994 066 089	white				52°
8 994 056 089	silver grey				138°

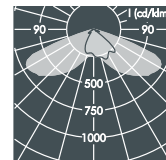
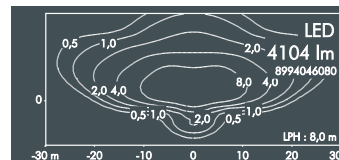

Part number	Description	Beam angle γ (FWHM)
. 3.	Luminaire with linear beam spread, horizontal	
. 7.	Luminaire with linear beam spread, rotatable with external ribbed glass spreader lens, continuously adjustable through 360° from outside the luminaire	C 0 – 180 5°
. 5	Luminaire with neutral white colour temperature (4000 K)	C 90 – 270 24°
. 1..	Dimmable luminaire (DALI)	



Monospot S4 RGBW, narrow beam*

Part number	Colour	Weight	Light source	Luminous flux	Beam angle γ (FWHM)
8 994 049 019	black	3.1 kg	6 x LED module RGBW W = 3000 K (max. 48 W)	max. 1770 lm	13°
8 994 069 019	white				
8 994 059 019	silver grey				

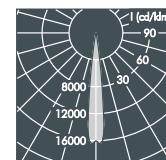
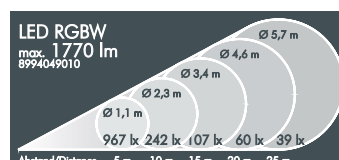

* Further distribution options are available upon request.

LED

Luminaires available in 2700 K and other colour temperatures upon request



Monospot S4 pole luminaire

With high performance LED or LED module Zhaga, integral temperature monitoring device, CRI: > 80, Colour tolerance: max. 2 SDCM Service life: L90/B10 > 50 000 h protection class I, IP65 , IK08 windage area AW 0.027 m²

corrosion-resistant die cast aluminium housing AISi12, polyester powder coated, precise PMMA optics, highly efficient aluminium indirect reflector or silicon optic, all exterior steel parts are stainless steel, tempered safety glass, silicon gasket, closure with 3 stainless steel screws, for installation on poles Ø 60 - 100 mm, tiltable base made of powder coated aluminium, 2 drilled holes Ø 9 mm, spacing 95 mm, 1 drilled hole Ø 13.5 mm, tilt range 90°, swivel range 360°, M20 cable gland, integral driver (AC/DC) or integral RGBW driver (DMX - RDM)

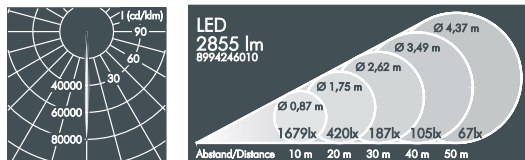
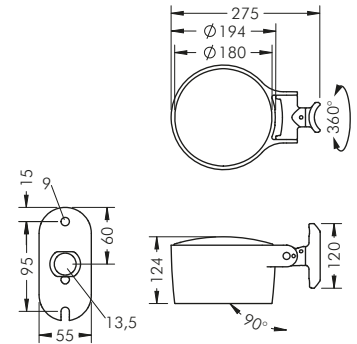

Monospot S4 pole luminaire, narrow beam

Part number	Colour	Weight	Light source	Luminous flux	Beam angle γ (FWHM)
8 994 246 019	black	3.3 kg	6 x LED 7.7 W	2855 lm	5°
8 994 266 019	white		(46 W)		
8 994 256 019	silver grey		warm white (3000 K)		

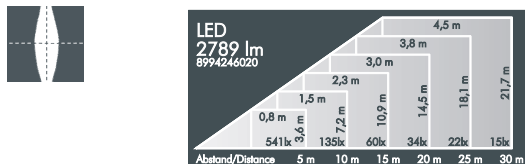

Monospot S4 pole luminaire, linear beam spread, vertical

Part number	Colour	Weight	Light source	Luminous flux	Beam angle γ (FWHM)
8 994 246 029	black	3.3 kg	6 x LED 7.7 W	2789 lm	C 0 - 180
8 994 266 029	white		(46 W)		40°
8 994 256 029	silver grey		warm white (3000 K)		8°



Monospot S4 pole luminaire, medium wide beam

Part number	Colour	Weight	Light source	Luminous flux	Beam angle γ (FWHM)
8 994 246 049	black	3.3 kg	6 x LED 7.7 W	2385 lm	35°
8 994 266 049	white		(46 W)		
8 994 256 049	silver grey		warm white (3000 K)		

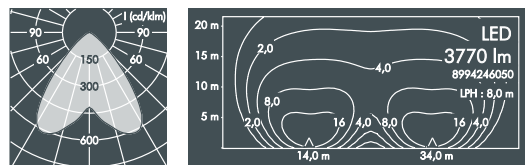

Monospot S4 pole luminaire, wide beam (with indirect reflector)

Part number	Colour	Weight	Light source	Luminous flux	Beam angle γ (FWHM)
8 994 246 059	black	3.2 kg	1 x LED module 45 W	3770 lm	92°
8 994 266 059	white		warm white (3000 K)		
8 994 256 059	silver grey				

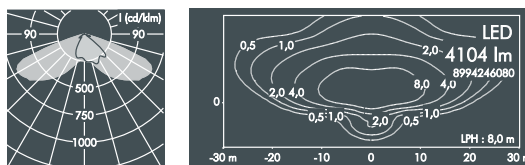

Monospot S4 pole luminaire, Street Optic

Part number	Colour	Weight	Light source	Luminous flux	Beam angle γ (FWHM)
8 994 246 089	black	3.3 kg	1 x LED module 46 W	4104 lm	C 0 - 180
8 994 266 089	white		warm white (3000 K)		52°
8 994 256 089	silver grey				138°

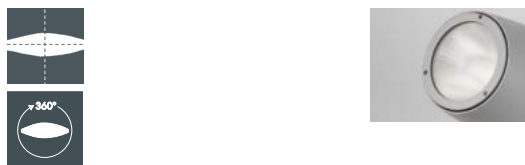

Part number	Description	Beam angle γ (FWHM)
... .. .3.	Luminaire with linear beam spread, horizontal	
... .. .7.	Luminaire with linear beam spread, rotatable with external ribbed glass spreader lens, continuously adjustable through 360° from outside the luminaire	C 0 - 180 5°
... .. .5 ...	Luminaire with neutral white colour temperature (4000 K)	C 90 - 270 24°
... .. .1 ..	Dimmable luminaire (DALI)	

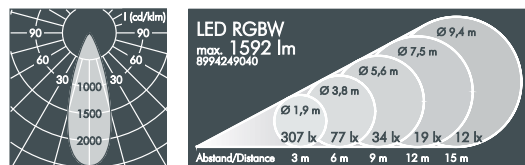

Monospot S4 pole luminaire RGBW, medium wide beam

Part number	Colour	Weight	Light source	Luminous flux	Beam angle γ (FWHM)
8 994 249 049	black	3.4 kg	6 x LED module RGBW	max. 1592 lm	35°
8 994 269 049	white		W = 3000 K		
8 994 259 049	silver grey		(max. 48 W)		

* Further distribution options are available upon request.

LED

Luminaires available in 2700 K and other colour temperatures upon request



Accessories Monospot S internal, **factory fitted**

Monospot S3, S4

Part number	Luminaire	Description	Beam angle γ (FWHM)	
			narrow beam	medium wide beam
129 0 734 000	Monospot S3	Prismatic glass,	18°	37°
129 0 735 000	Monospot S4	for diffused light distribution	19°	46°

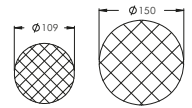

Monospot S1, S2

Part number	Luminaire	Description
129 0 831 000	Monospot S1	Honeycomb louvre, internal (factory fitted),
129 0 832 000	Monospot S2	to avoid glare



Monospot S3, S4

Part number	Luminaire	Description
129 0 753 000	Monospot S3	Honeycomb louvre, internal (factory fitted),
129 0 754 000	Monospot S4	to avoid glare

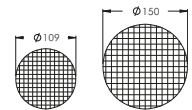

The internally fitted honeycomb louvre offers effective glare control and is protected from build up of dirt.





Monospot S1		Monospot S2			
Part number	Part number	Colour	Description		
129 0 841 940	129 0 842 940	black	Cowl , stainless steel, to avoid lateral glare, for retro-fitting		
129 0 841 960	129 0 842 960	white			
129 0 841 950	129 0 842 950	silver grey			



Monospot S3		Monospot S4			
Part number	Part number	Colour	Description		
129 0 843 940	129 0 844 940	black	Cowl , stainless steel, to avoid lateral glare, for retro-fitting		
129 0 843 960	129 0 844 960	white			
129 0 843 950	129 0 844 950	silver grey			

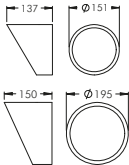

Monospot S1, S2

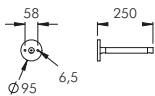

Part number	Colour	Description
129 0 500 940	black	Wall arm 250 mm , aluminium, polyester powder coated
129 0 500 960	white	
129 0 500 950	silver grey	

Monospot S3, S4

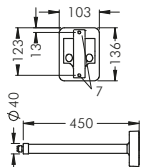

Part number	Colour	Description
128 0 901 940	black	Wall arm 450 mm* , aluminium, polyester powder coated
128 0 901 960	white	
128 0 901 950	silver grey	

*available in different lengths upon request

Monospot S1, S2

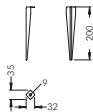

Part number	Colour	Description
129 0 731 940	black	Stainless steel earth spike , for use in landscape lighting
129 0 731 960	white	
129 0 731 950	silver grey	

Monospot S3, S4

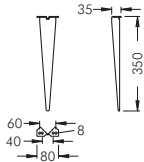

Part number	Colour	Description
129 0 736 940	black	Stainless steel earth spike , for use in landscape lighting
129 0 736 960	white	
129 0 736 950	silver grey	

Monospot S1, S2 Monospot S3, S4

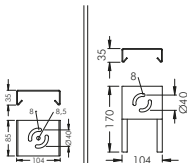

Part number	Part number	Description
120 0 620 940	120 0 622 940	Expandable tree strap with mounting plate , made of polyester fiber for trunk circumference 350 – 450 mm*, with polyester powder coated mounting plate

*different lengths available upon request

Monospot S3, S4 (with mounting bracket)

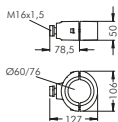

Part number	Colour	Description
129 0 790 940	black	Single pole mount clamp , aluminium, for poles \varnothing 60 mm
129 0 790 960	white	
129 0 790 950	silver grey	

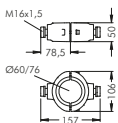

Part number	Colour	Description
129 0 792 940	black	Single pole mount clamp , aluminium, for poles \varnothing 76 mm
129 0 792 960	white	
129 0 792 950	silver grey	
129 0 791 940	black	Double pole mount clamp , aluminium, for poles \varnothing 60 mm
129 0 791 960	white	
129 0 791 950	silver grey	
129 0 793 940	black	Double pole mount clamp , aluminium, for poles \varnothing 76 mm
129 0 793 960	white	
129 0 793 950	silver grey	



Willy Meyer+Sohn GmbH+Co. KG
Stemmessiepener Weg 5
58675 Hemer
Germany
Phone: +49 2372 9891-0
Fax: +49 2372 9891-48
E-mail: info@meyer-lighting.com
www.meyer-lighting.com

