

nekolighting.com  
**THINK DESIGN**

**NEKO**  
LIGHTING

Catalogue 2019

NEKO LIGHTING AG

📍 Kreuzstrasse 2, CH-8008 Zürich / Switzerland

☎ +41 44 451 80 15

✉ sales@nekolighting.com

🌐 www.nekolighting.com



**NEKO**  
**THINK DESIGN**  
Architectural Lighting  
**2019**

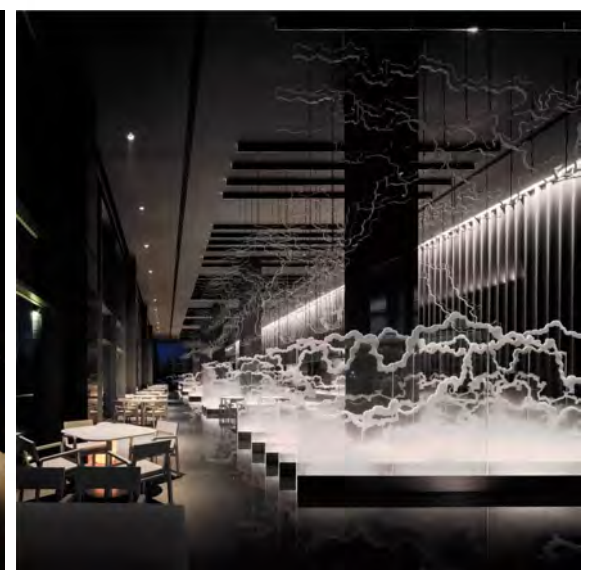
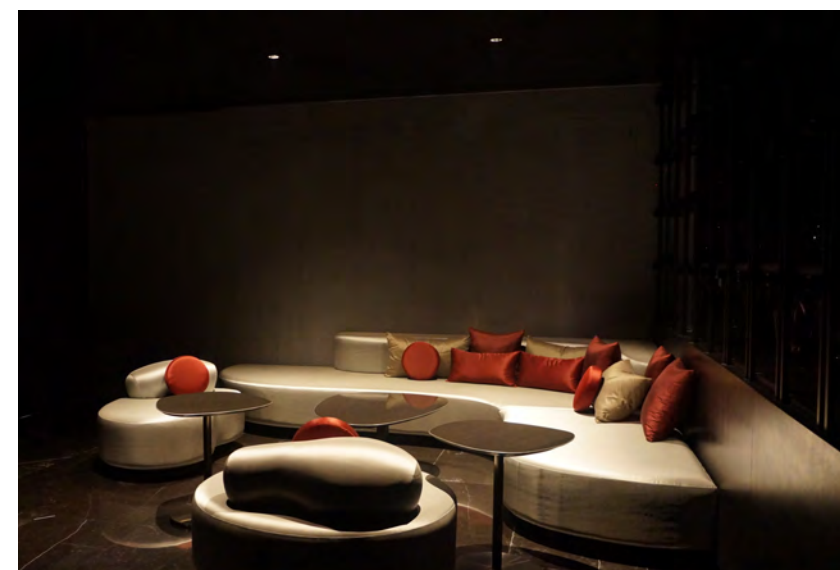

#### ◦ Design

Der in Zürich ansässige Designer OLIVER KÖNIGS weiss aus seiner langjährigen Erfahrung als Beleuchtungsberater, dass sich gute Einbauleuchten nahtlos und unaufdringlich in die Architektur einfügen müssen. Eine gute Einbauleuchte erfüllt ihre Aufgabe verdeckt im Hintergrund. Er ist jedoch davon überzeugt, dass von einer hervorragenden Einbauleuchte nicht nur der sichtbare Teil perfekt aussehen muss, sondern dass auch die Teile hinter der Zimmerdecke, die normalerweise verborgen bleiben, präzise und zweckgemäss geformt eingefügt werden müssen.

Aus diesem Grunde stellen die Einbauleuchten, die von OLIVER KÖNIGS designed werden, ein kohärentes Ensemble von Komponenten dar, die sich in ihrer Form sorgfältig an ihre spezifische Funktion anpassen, sich gleichzeitig aber auf klare und sichtbare Konturen beschränken. Abgesehen von dem einzigartigen und ansprechenden Aussehen des Produkts bietet die Ausgestaltung der Komponenten als flexible Module die verschiedensten Gestaltungsmöglichkeiten. Auf diese Weise können jede Menge unterschiedlicher Lichtlösungen mit einer einzigen Leuchtenfamilie abgedeckt werden.



Oliver Königs

#### ◦ Design

Zurich based designer OLIVER KOENIGS knows from his long experience as lighting consultant that a good downlight has to integrate itself smoothly and unobtrusively into the architecture. Therefore a good downlight discretely performs its actual service concealed in the background. However, he is convinced that of an excellent downlight, not only the instantly apparent outlet has to look perfect, but that also the usually unseen parts above the ceiling have to be shaped and concerted in a precise and utile manner.

Therefore the NEKO downlights designed by OLIVER KOENIGS feature a coherent arrangement of components, in which the shape of each component is carefully derived from its specific function and at the same time reduced to clear and distinct outlines. Apart from the unique and pleasant appearance of the product, this arrangement of components results in a flexible modularity with various configurations. Thus, plenty of different lighting tasks can be covered by this single downlight family.



# INDEX

## SENSE 45 Series

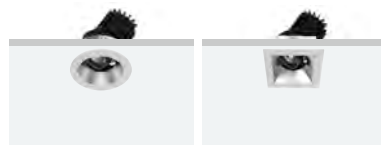

SENSE45-S45R1 ■020-021    SENSE45-S45S1 ■022-023

## SENSE 68 Series



SENSE68-S68R1 ■024-025    SENSE68-S68S1 ■026-027

## SENSE 100 Series



SENSE100-S100R1 ■028-029    SENSE100-S100S1 ■030-031    SENSE100-S100R2 ■032-033    SENSE100-S100S2 ■034-035    SENSE100-S100R3 ■036-037    SENSE100-S100S3 ■038-039

## SENSE 125 Series



SENSE125-S125R1 ■040-041    SENSE125-S125S1 ■042-043    SENSE125-S125R2 ■044-045    SENSE125-S125S2 ■046-047    SENSE125-S125R3 ■048    SENSE125-S125S3 ■049

## SENSE 150 Series



SENSE150-S150R1 ■050-051    SENSE150-S150S1 ■052-053    SENSE150-S150R2 ■054-055    SENSE150-S150S2 ■056-057    SENSE150-S150R3 ■058    SENSE150-S150S3 ■059

## NEKO Code Introduction

[Code\_Prefix]-[Electrical-optical Info.]-[Color Info]-[Accessories]

\*\*\*\* - \* \*\* \*\* \* - \* \* - \*

SSR1 - 9 30 28 13 D - W S - H

↑                    ↑                    ↑                    ↑                    ↑                    ↑                    ↑

Acronym of Model    CRI    CCT    Beam Angle    Lighting Control    Fixture Color    Reflector / Decoration Ring Color    Accessories

SSR1-9302813D-WS-H

- SENSE100, Round Trim, Adjustable Version,
- CRI90, CCT3000K, Beam 28D, 13W, DALI Control,
- White Trim, Specular 2<sup>nd</sup> Reflector,
- with Honeycomb.

SLS3-940WW25A-WM

- SENSE150, Square Trim, Wall Washer,
- CRI90, CCT4000K, Wall Washer, 25W, 1-10V Control,
- White Trim, Matt 2<sup>nd</sup> Reflector.

## TAKEO Round Series



TAKEO-T100 ■064-065    TAKEO-T150 ■066-067    TAKEO-T200 ■068-069



TAKEO-T150C ■070-071

## TAKEO Square Series



TAKEO-TS100 ■074    TAKEO-TS150 ■075    TAKEO-TS200 ■076-077

## SIGN Series



SIGN35-G ■082    SIGN45-G ■083

## MR16 Replacement



M1 ■086    M2 ■087    M3 ■100-101

## CLUB Trim Series for MR16 Replacement



TA5 ■090-099    KA5    TA6    TSA1    KSA1



# INDEX

## FUSION Fixed



## FUSION Fixed Trimless

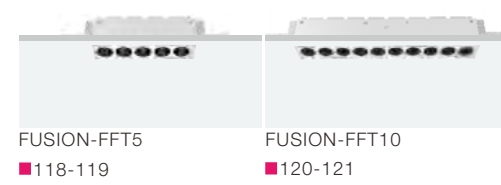

## FUSION Adjustable

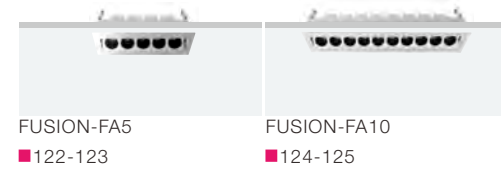

## FUSION Wall Washer

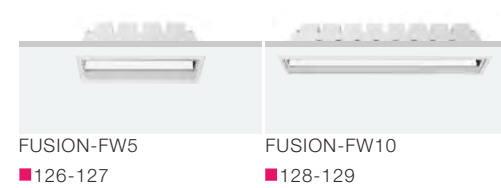

## FUSION General Light

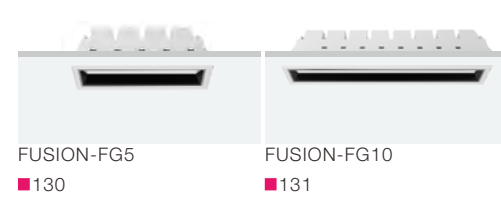

## FUSION Linear System

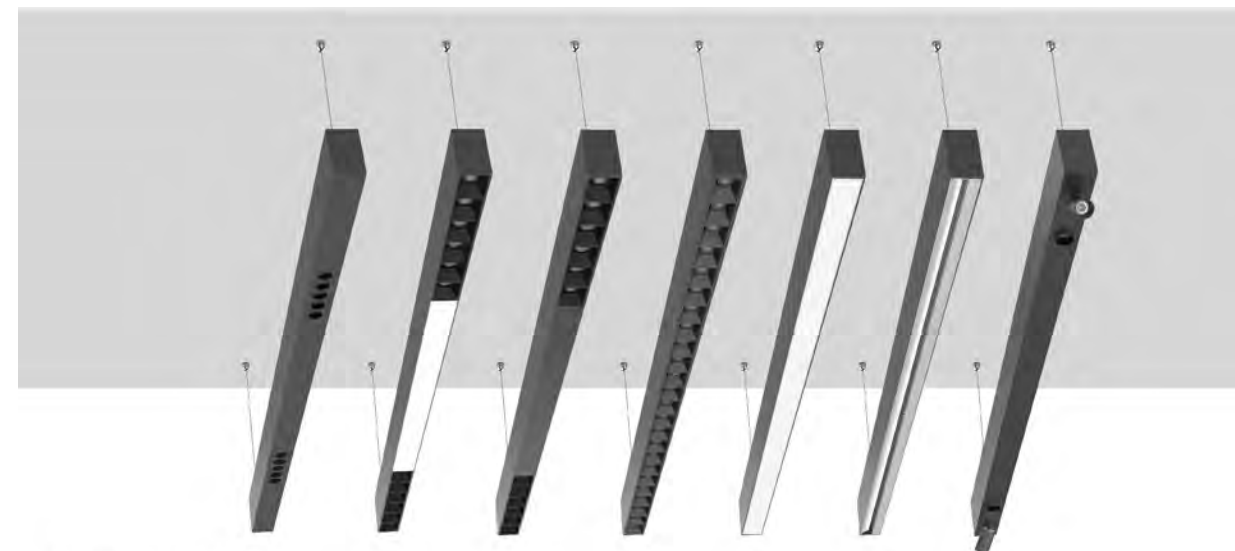

FUSION LINEAR SYSTEM  
■132-161

## MODULINE35 Linear System



## GAME & SUGAR Ceiling Light Series **NEW**



## PURE LED Tracklight



## PURE-C Ceiling Mounted PURE S Tracklight **NEW**



## FOCUS LED Tracklight

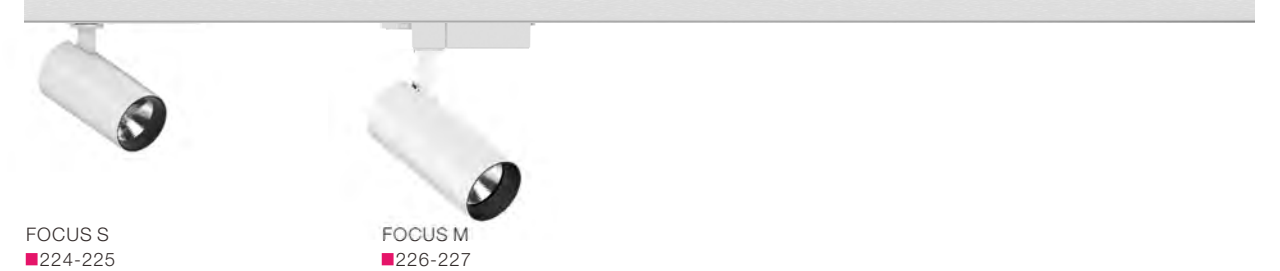

## BO LED Tracklight

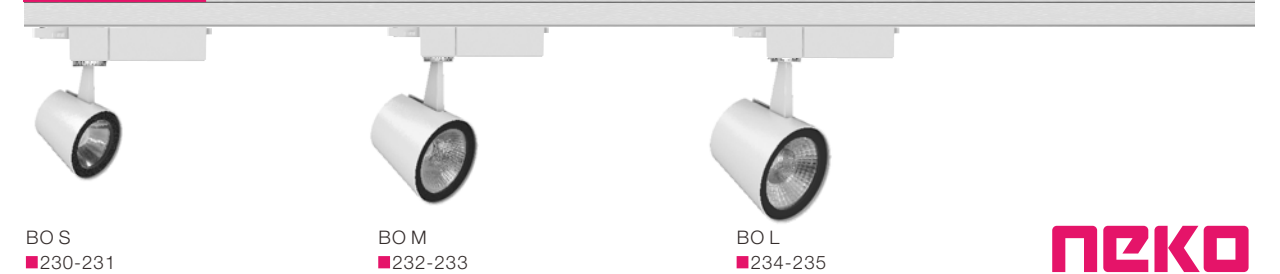





One light engine with various accessories  
Easy to specify  
Easy to manage stock  
Easy to install and adjust  
Easy to change reflector



Adjustable/Fixed/Wall Washer

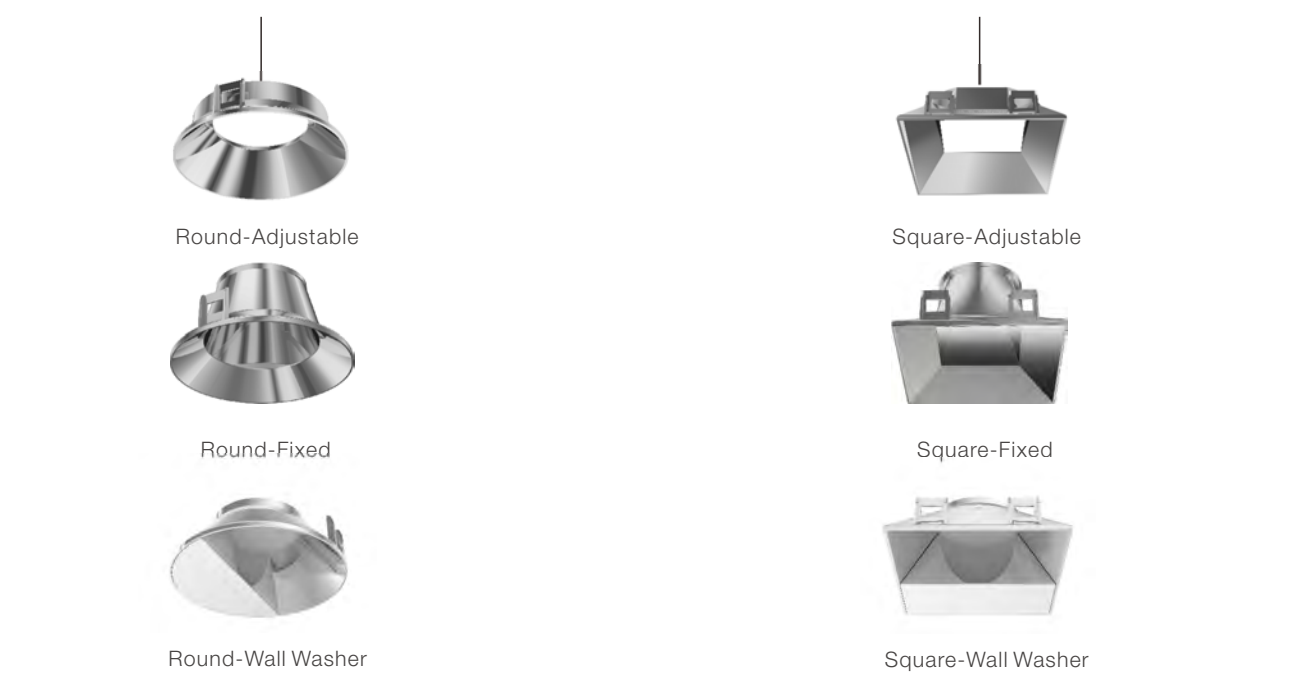

Secondary Reflector



Specular Chrome Black Matt White Black Gold



Qualitäts-LED: CITIZEN COB CRI>90  
High quality LED: CITIZEN COB CRI >90

Beste optische Lichtsteuerung: enger oder mittlerer Ausstrahlungsgrad  
Best optical control: Narrow or Medium beam

IP 54 Schutz für LED  
IP 54 protection for LED

Optionaler Blendschutz für UGR Kontrolle  
Optional honeycomb mesh for best UGR control

Anti-Blendschutzring für besten Sehkomfort UGR<19  
Anti-glare ring provides eye-comfort UGR<19

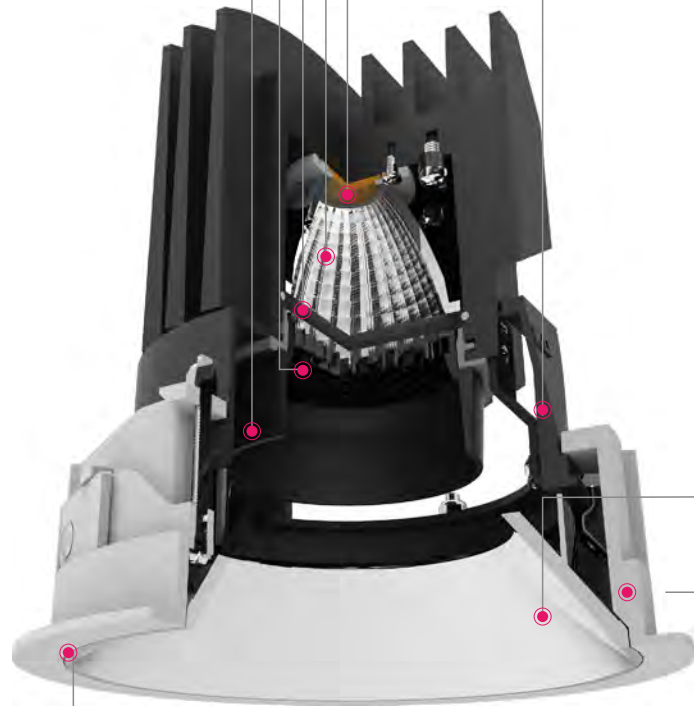

Technologie präsentiert Kunst  
Technology Presents Arts

Ultra schmales Rahmendesign  
keinen Flansch zwischen dem sekundären Reflektor und dem Rahmen

Ultra-narrow trim design leaves  
no flange between the secondary  
reflector and trim.



Präzise Winkelpositionierung  
Precise angle alignment

Präzisionsgefertigte Anpassung erreicht  
genaue Winkelpositionierung  
Precision engineered adjustment  
mechanism achieves accurate  
angle alignment.

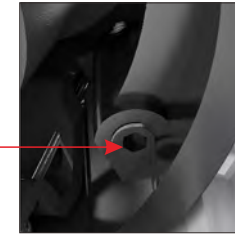

Einheitliches Design für die feste oder einstellbare Version  
One design for fixed or adjustable performance

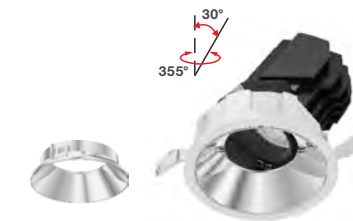

Die einstellbare Version mit 30° Neigung und 355° Rotation  
Standard adjustable reflector with 30 tilt and 355 rotation



Zweitreflektor reduziert die Deckenblendung  
Optional fixed reflector avoids visible ceiling aperture

Erweiterte Deckenmontage  
Advanced ceiling installation



Standard trim

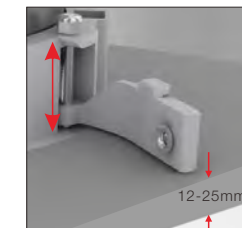

ceiling thickness  
12mm to 25mm

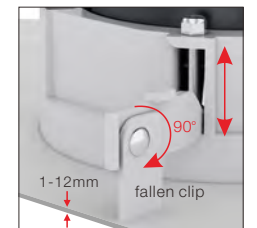

ceiling thickness  
1mm to 12mm

Rahmenlose Installation  
Trimless Installation

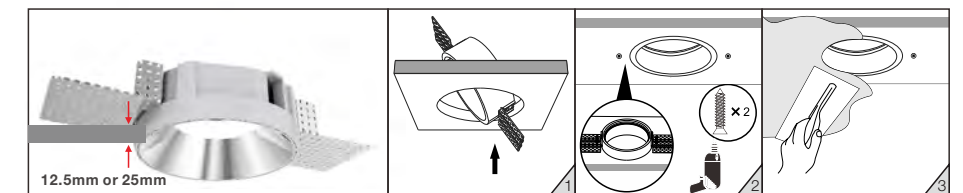



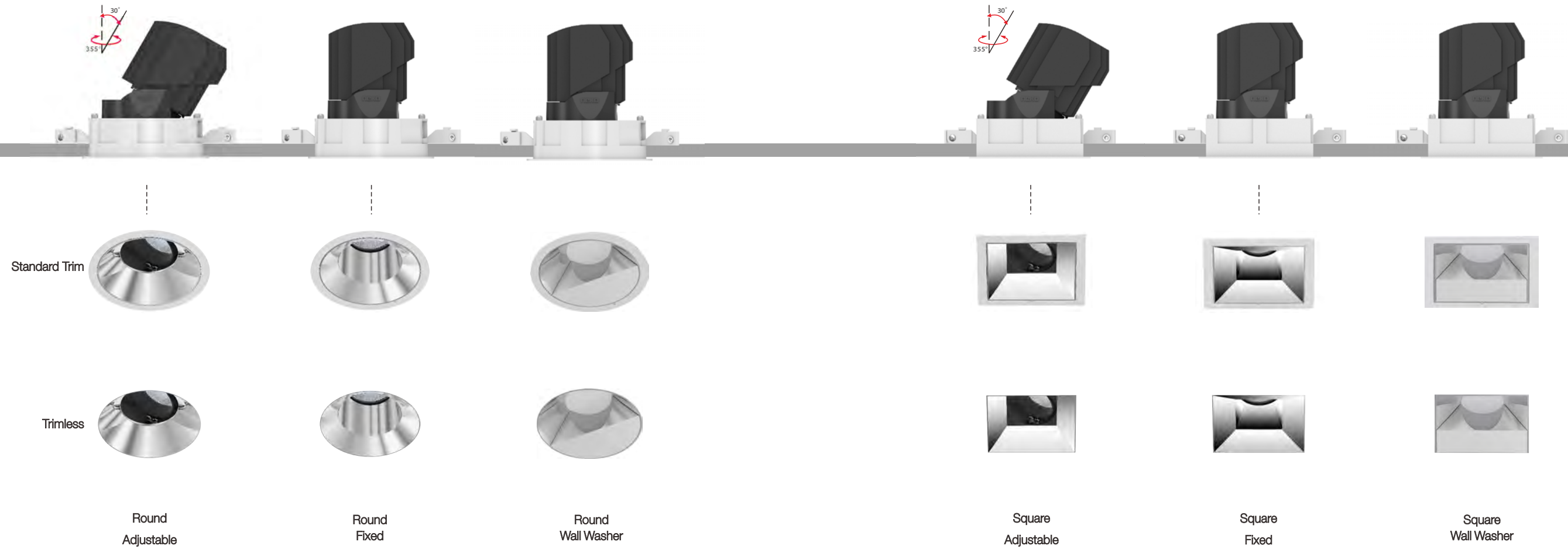













**NEKO / SENSE**  
LED Downlight System



# SENSE

## LED DOWNLIGHT SYSTEM

	Adjustable										Fixed						Wall Washer					
Picture & name	 SENSE Round Adjustable					 SENSE Square Adjustable					 SENSE Round Fixed			 SENSE Square Fixed			 SENSE Round Wall Washer			 SENSE Square Wall Washer		
Cutout diameter(mm)	Ø45	Ø68	Ø100	Ø125	Ø150	45X45	68X68	96X96	122X122	147X147	Ø100	Ø125	Ø150	96X96	122X122	147X147	Ø100	Ø125	Ø150	96X96	122X122	147X147
Trim diameter(mm)	S45R1 Ø55	S68R1 Ø78	S100R1 Ø110	S125R1 Ø137	S150R1 Ø162	S45S1 55X55	S68S1 78X78	S100S1 107X107	S125S1 134X134	S150S1 159X159	S100R2 Ø110	S125R2 Ø137	S150R2 Ø162	S100S2 107X107	S125S2 134X134	S150S2 159X159	S100R3 Ø110	S125R3 Ø137	S150R3 Ø162	S100S3 107X107	S125S3 134X134	S150S3 159X159
Height(mm)	H: 60	H: 92	H: 121	H: 162	H: 212	H: 60	H: 92	H: 121	H: 162	H: 212	H: 121	H: 162	H: 212	H: 121	H: 162	H: 212	H: 121	H: 162	H: 212	H: 121	H: 162	H: 212
Wattage and Luminous flux	Standard 4W 350lm	Standard 11W 800lm	Standard 13W 850lm	Standard 18W 1300lm	Standard 25W 1800lm	Standard 4W 350lm	Standard 11W 800lm	Standard 13W 850lm	Standard 18W 1300lm	Standard 25W 1800lm	Standard 13W 900lm	Standard 18W 1400lm	Standard 25W 1900lm	Standard 13W 900lm	Standard 18W 1400lm	Standard 25W 1900lm	Standard 13W 480lm	Standard 18W 750lm	Standard 25W 1000lm	Standard 13W 480lm	Standard 18W 750lm	Standard 25W 1000lm
Beam angle	Standard Medium		Option Narrow	Option Wide	Standard Medium		Option Narrow	Option Wide	Standard Medium			Option Narrow	Option Wide	Standard Medium	Option Narrow	Option Wide	Standard Wall Washer			Standard Wall Washer		
Color temperature	2700K		3000K	4000K	3000K		2700K	4000K	2700K			3000K	4000K	2700K	3000K	4000K	2700K	3000K	4000K	2700K	3000K	4000K
Color rendering index	Standard CRI>90			Option CRI>80	Standard CRI>90			Option CRI>80	Standard CRI>90			Option CRI>80	Standard CRI>90	Option CRI>80	Standard CRI>90	Option CRI>80	Standard CRI>90	Option CRI>80	Standard CRI>90	Option CRI>80		
LED Driver	Standard ON-OFF			Option PHASE DIM 1-10V DIM DALI DIM	Standard ON-OFF			Option PHASE DIM 1-10V DIM DALI DIM	Standard ON-OFF			Option PHASE DIM 1-10V DIM DALI DIM	Standard ON-OFF	Option PHASE DIM 1-10V DIM DALI DIM	Standard ON-OFF	Option PHASE DIM 1-10V DIM DALI DIM	Standard ON-OFF	Option PHASE DIM 1-10V DIM DALI DIM	Standard ON-OFF	Option PHASE DIM 1-10V DIM DALI DIM		
Trimless version																						
Secondary reflector	     					     																
Anti-glare Accessory	 honeycomb																					

Narrow beam: 15°-29°    Medium beam: 30°-45°    Wide beam: 46°-60°





SENSE45 Series



SENSE68 Series



SENSE100 Series

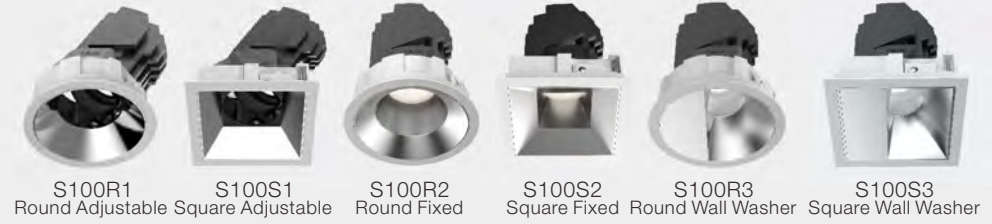

SENSE125 Series



SENSE150 Series

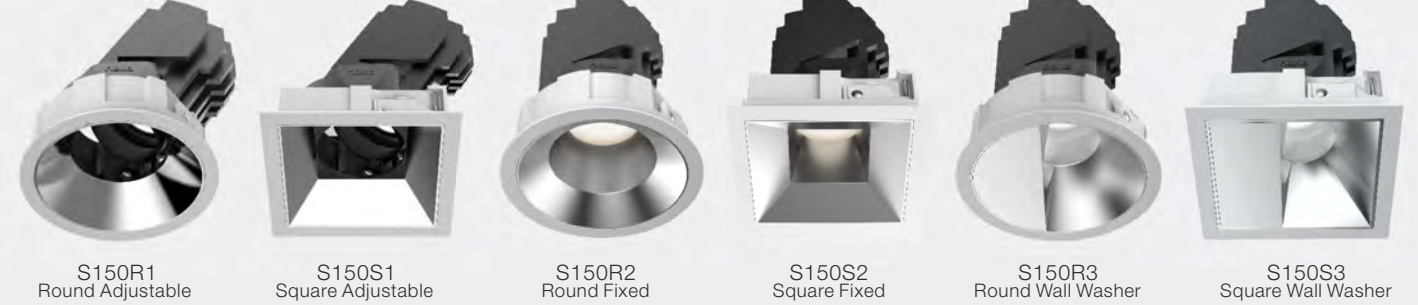

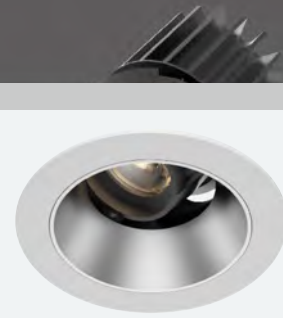

NEKO / SENSE 45 / S45R1  
Adjustable LED Downlight

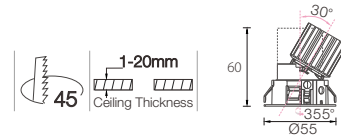

4W CRI90 2700K 18° CREE UGR < 19 IP20 5 YEAR GUARANTEE CB CE



	LED Power	System Power	LED Voltage	LED Current	CRI	CCT	Beam	LED Output	System Output	Code	
 Matt Reflector	4 W	6 W	12 V	350 mA	90	2700K	18°	480lm	330lm	SUR1-9271804X-WM	
							24°	480lm	330lm	SUR1-9272404X-WM	
							35°	480lm	330lm	SUR1-9273504X-WM	
							50°	480lm	330lm	SUR1-9275004X-WM	
							3000K	18°	500lm	350lm	SUR1-9301804X-WM
								24°	500lm	350lm	SUR1-9302404X-WM
								35°	500lm	350lm	SUR1-9303504X-WM
								50°	500lm	350lm	SUR1-9305004X-WM
							4000K	18°	550lm	380lm	SUR1-9401804X-WM
								24°	550lm	380lm	SUR1-9402404X-WM
								35°	550lm	380lm	SUR1-9403504X-WM
								50°	550lm	380lm	SUR1-9405004X-WM
 White Reflector	4 W	6 W	12 V	350 mA	90	2700K	18°	480lm	330lm	SUR1-9271804X-WW	
							24°	480lm	330lm	SUR1-9272404X-WW	
							35°	480lm	330lm	SUR1-9273504X-WW	
							50°	480lm	330lm	SUR1-9275004X-WW	
							3000K	18°	500lm	350lm	SUR1-9301804X-WW
								24°	500lm	350lm	SUR1-9302404X-WW
								35°	500lm	350lm	SUR1-9303504X-WW
								50°	500lm	350lm	SUR1-9305004X-WW
							4000K	18°	550lm	380lm	SUR1-9401804X-WW
								24°	550lm	380lm	SUR1-9402404X-WW
								35°	550lm	380lm	SUR1-9403504X-WW
								50°	550lm	380lm	SUR1-9405004X-WW
 Black Reflector	4 W	6 W	12 V	350 mA	90	2700K	18°	480lm	330lm	SUR1-9271804X-WB	
							24°	480lm	330lm	SUR1-9272404X-WB	
							35°	480lm	330lm	SUR1-9273504X-WB	
							50°	480lm	330lm	SUR1-9275004X-WB	
							3000K	18°	500lm	350lm	SUR1-9301804X-WB
								24°	500lm	350lm	SUR1-9302404X-WB
								35°	500lm	350lm	SUR1-9303504X-WB
								50°	500lm	350lm	SUR1-9305004X-WB
							4000K	18°	550lm	380lm	SUR1-9401804X-WB
								24°	550lm	380lm	SUR1-9402404X-WB
								35°	550lm	380lm	SUR1-9403504X-WB
								50°	550lm	380lm	SUR1-9405004X-WB

Code Remark: X=F(ON-OFF) X=P(Phase Dim) X=A(1-10V Dim) X=D(DALI Dim)

Optional accessory



Code for SUR1-9302404X-WM with Honeycomb  
SUR1-9302404X-WM-H

Ultra Tiny

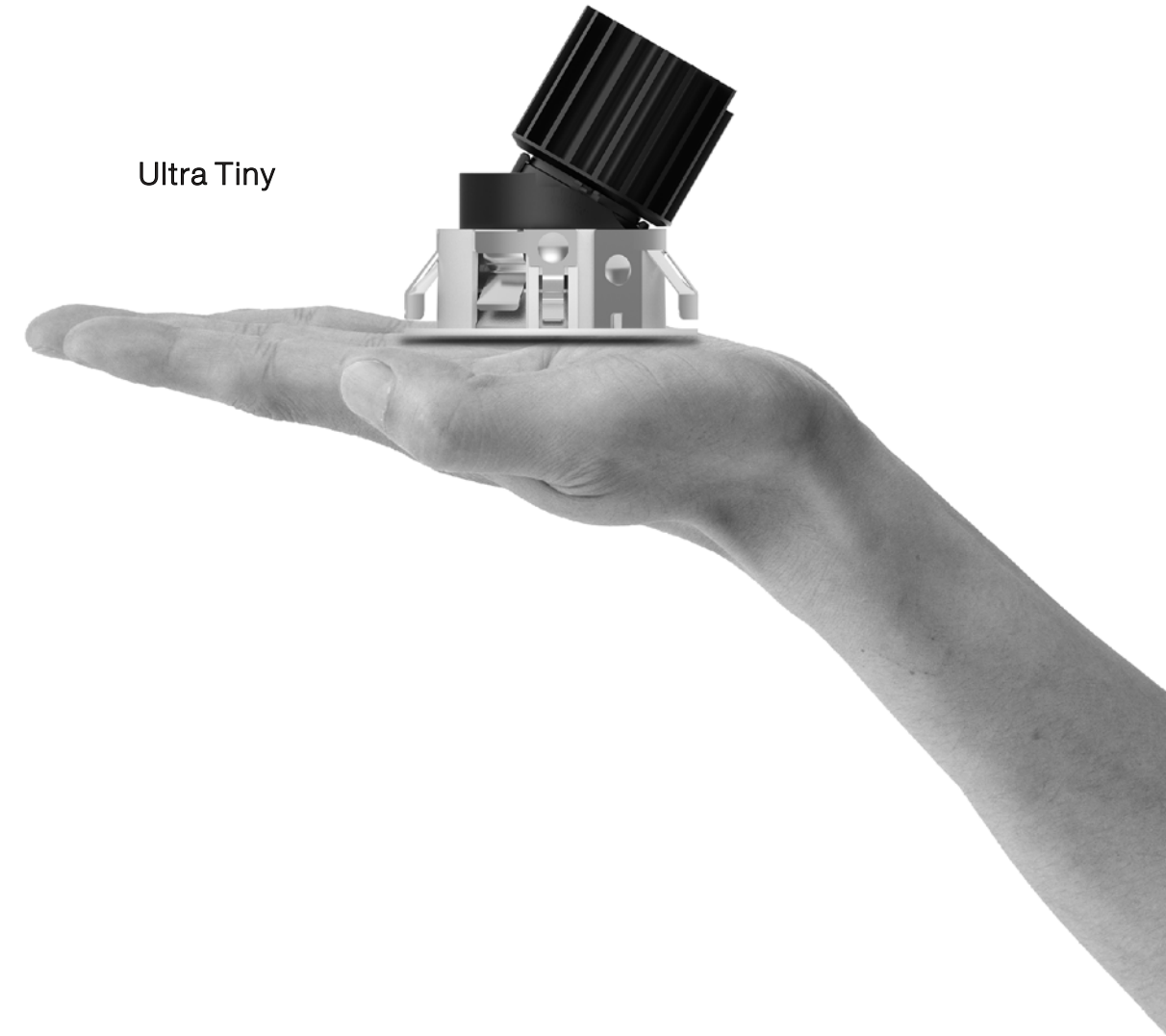



NEKO / SENSE 45 / S45S1  
Adjustable LED Downlight

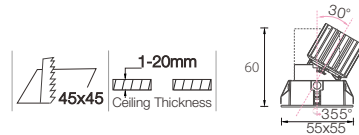

4W CRI90 2700K 18° 24° 35° 50° CRI80 3000K 4000K CREE UGR < 19 IP20 5 YEAR GUARANTEE CB CE



	LED Power	System Power	LED Voltage	LED Current	CRI	CCT	Beam	LED Output	System Output	Code	
 Matt Reflector	4 W	6 W	12 V	350 mA	90	2700K	18°	480lm	330lm	SUS1-9271804X-WM	
							24°	480lm	330lm	SUS1-9272404X-WM	
							35°	480lm	330lm	SUS1-9273504X-WM	
							50°	480lm	330lm	SUS1-9275004X-WM	
							3000K	18°	500lm	350lm	SUS1-9301804X-WM
								24°	500lm	350lm	SUS1-9302404X-WM
								35°	500lm	350lm	SUS1-9303504X-WM
								50°	500lm	350lm	SUS1-9305004X-WM
							4000K	18°	550lm	380lm	SUS1-9401804X-WM
								24°	550lm	380lm	SUS1-9402404X-WM
								35°	550lm	380lm	SUS1-9403504X-WM
								50°	550lm	380lm	SUS1-9405004X-WM
 White Reflector	4 W	6 W	12 V	350 mA	90	2700K	18°	480lm	330lm	SUS1-9271804X-WW	
							24°	480lm	330lm	SUS1-9272404X-WW	
							35°	480lm	330lm	SUS1-9273504X-WW	
							50°	480lm	330lm	SUS1-9275004X-WW	
							3000K	18°	500lm	350lm	SUS1-9301804X-WW
								24°	500lm	350lm	SUS1-9302404X-WW
								35°	500lm	350lm	SUS1-9303504X-WW
								50°	500lm	350lm	SUS1-9305004X-WW
							4000K	18°	550lm	380lm	SUS1-9401804X-WW
								24°	550lm	380lm	SUS1-9402404X-WW
								35°	550lm	380lm	SUS1-9403504X-WW
								50°	550lm	380lm	SUS1-9405004X-WW
 Black Reflector	4 W	6 W	12 V	350 mA	90	2700K	18°	480lm	330lm	SUS1-9271804X-WB	
							24°	480lm	330lm	SUS1-9272404X-WB	
							35°	480lm	330lm	SUS1-9273504X-WB	
							50°	480lm	330lm	SUS1-9275004X-WB	
							3000K	18°	500lm	350lm	SUS1-9301804X-WB
								24°	500lm	350lm	SUS1-9302404X-WB
								35°	500lm	350lm	SUS1-9303504X-WB
								50°	500lm	350lm	SUS1-9305004X-WB
							4000K	18°	550lm	380lm	SUS1-9401804X-WB
								24°	550lm	380lm	SUS1-9402404X-WB
								35°	550lm	380lm	SUS1-9403504X-WB
								50°	550lm	380lm	SUS1-9405004X-WB

Code Remark: X=F(ON-OFF) X=P(Phase Dim) X=A(1-10V Dim) X=D(DALI Dim)

Optional accessory



Code for SUS1-9302404X-WM with Honeycomb  
SUS1-9302404X-WM-H

Ultra Tiny





**NEKO / SENSE 68 / S68R1**  
Adjustable LED Downlight



7.5W CRI90 2700K 24° 11W CRI80 3000K 40° 4000K 55° 10° CITIZEN 50,000h@L80B10 UGR < 19 IP20 5 YEAR GUARANTEE CB CE C-UL US LISTED 68 1-25mm Ceiling Thickness 355 30° 078

LED Power	System Power	LED Voltage	LED Current	CRI	CCT	Beam	LED Output	System Output	Code							
7.5 W	9 W	31 V	250 mA	90	3000K	24°	900lm	600lm	STR1-9302408X-WS							
						40°	900lm	600lm	STR1-9304008X-WS							
						55°	900lm	500lm	STR1-9305508X-WS							
						4000K	24°	1000lm	650lm	STR1-9402408X-WS						
							40°	1000lm	650lm	STR1-9404008X-WS						
							55°	1000lm	550lm	STR1-9405508X-WS						
						11 W	13 W	31 V	350 mA	90	3000K	24°	1200lm	800lm	STR2-9302411X-WS	
												40°	1200lm	800lm	STR2-9304011X-WS	
												55°	1200lm	650lm	STR2-9305511X-WS	
												4000K	24°	1300lm	850lm	STR2-9402411X-WS
													40°	1300lm	850lm	STR2-9404011X-WS
													55°	1300lm	700lm	STR2-9405511X-WS
7.5 W	9 W	31 V	250 mA	90	3000K							24°	900lm	600lm	STR1-9302408X-WM	
												40°	900lm	600lm	STR1-9304008X-WM	
												55°	900lm	500lm	STR1-9305508X-WM	
												4000K	24°	1000lm	650lm	STR1-9402408X-WM
													40°	1000lm	650lm	STR1-9404008X-WM
													55°	1000lm	550lm	STR1-9405508X-WM
						11 W	13 W	31 V	350 mA	90	3000K	24°	1200lm	800lm	STR2-9302411X-WM	
												40°	1200lm	800lm	STR2-9304011X-WM	
												55°	1200lm	650lm	STR2-9305511X-WM	
												4000K	24°	1300lm	850lm	STR2-9402411X-WM
													40°	1300lm	850lm	STR2-9404011X-WM
													55°	1300lm	700lm	STR2-9405511X-WM
7.5 W	9 W	31 V	250 mA	90	3000K							24°	900lm	600lm	STR1-9302408X-WB	
												40°	900lm	600lm	STR1-9304008X-WB	
												55°	900lm	500lm	STR1-9305508X-WB	
												4000K	24°	1000lm	650lm	STR1-9402408X-WB
													40°	1000lm	650lm	STR1-9404008X-WB
													55°	1000lm	550lm	STR1-9405508X-WB
						11 W	13 W	31 V	350 mA	90	3000K	24°	1200lm	800lm	STR2-9302411X-WB	
												40°	1200lm	800lm	STR2-9304011X-WB	
												55°	1200lm	650lm	STR2-9305511X-WB	
												4000K	24°	1300lm	850lm	STR2-9402411X-WB
													40°	1300lm	850lm	STR2-9404011X-WB
													55°	1300lm	700lm	STR2-9405511X-WB

Code Remark: X=F(ON-OFF) X=P(Phase Dim) X=A(1-10V Dim) X=D(DALI Dim)

Optional accessory

 Code for STR1-9302408X-WM with Honeycomb  
STR1-9302408X-WM-H



LED Power	System Power	LED Voltage	LED Current	CRI	CCT	Beam	LED Output	System Output	Code							
7.5 W	9 W	31 V	250 mA	90	3000K	24°	900lm	600lm	STR1-9302408X-WC							
						40°	900lm	600lm	STR1-9304008X-WC							
						55°	900lm	500lm	STR1-9305508X-WC							
						4000K	24°	1000lm	650lm	STR1-9402408X-WC						
							40°	1000lm	650lm	STR1-9404008X-WC						
							55°	1000lm	550lm	STR1-9405508X-WC						
						11 W	13 W	31 V	350 mA	90	3000K	24°	1200lm	800lm	STR2-9302411X-WC	
												40°	1200lm	800lm	STR2-9304011X-WC	
												55°	1200lm	650lm	STR2-9305511X-WC	
												4000K	24°	1300lm	850lm	STR2-9402411X-WC
													40°	1300lm	850lm	STR2-9404011X-WC
													55°	1300lm	700lm	STR2-9405511X-WC
7.5 W	9 W	31 V	250 mA	90	3000K							24°	900lm	600lm	STR1-9302408X-WW	
												40°	900lm	600lm	STR1-9304008X-WW	
												55°	900lm	500lm	STR1-9305508X-WW	
												4000K	24°	1000lm	650lm	STR1-9402408X-WW
													40°	1000lm	650lm	STR1-9404008X-WW
													55°	1000lm	550lm	STR1-9405508X-WW
						11 W	13 W	31 V	350 mA	90	3000K	24°	1200lm	800lm	STR2-9302411X-WW	
												40°	1200lm	800lm	STR2-9304011X-WW	
												55°	1200lm	650lm	STR2-9305511X-WW	
												4000K	24°	1300lm	850lm	STR2-9402411X-WW
													40°	1300lm	850lm	STR2-9404011X-WW
													55°	1300lm	700lm	STR2-9405511X-WW
7.5 W	9 W	31 V	250 mA	90	3000K							24°	900lm	600lm	STR1-9302408X-WG	
												40°	900lm	600lm	STR1-9304008X-WG	
												55°	900lm	500lm	STR1-9305508X-WG	
												4000K	24°	1000lm	650lm	STR1-9402408X-WG
													40°	1000lm	650lm	STR1-9404008X-WG
													55°	1000lm	550lm	STR1-9405508X-WG
						11 W	13 W	31 V	350 mA	90	3000K	24°	1200lm	800lm	STR2-9302411X-WG	
												40°	1200lm	800lm	STR2-9304011X-WG	
												55°	1200lm	650lm	STR2-9305511X-WG	
												4000K	24°	1300lm	850lm	STR2-9402411X-WG
													40°	1300lm	850lm	STR2-9404011X-WG
													55°	1300lm	700lm	STR2-9405511X-WG

Code Remark: X=F(ON-OFF) X=P(Phase Dim) X=A(1-10V Dim) X=D(DALI Dim)

Trimless Version available

 Trimless code for STR1-9302408X-WM → STR3-9302408X-WM  
STR2-9302411X-WM → STR4-9302411X-WM

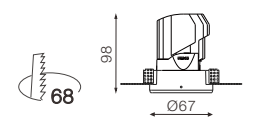



**NEKO / SENSE 68 / S68S1**  
Adjustable LED Downlight



7.5W CRI90 2700K 24° CITIZEN UGR < 19 IP 20 5 YEAR WARRANTY CB CE C UL US LISTED 68x68 1-25mm Ceiling Thickness 98 355° 30° 78X78

LED Power	System Power	LED Voltage	LED Current	CRI	CCT	Beam	LED Output	System Output	Code	
7.5 W	9 W	31 V	250 mA	90	3000K	24°	900lm	600lm	STS1-9302408X-WS	
						40°	900lm	600lm	STS1-9304008X-WS	
						55°	900lm	500lm	STS1-9305508X-WS	
						4000K	24°	1000lm	650lm	STS1-9402408X-WS
							40°	1000lm	650lm	STS1-9404008X-WS
							55°	1000lm	550lm	STS1-9405508X-WS
11 W	13 W	31 V	350 mA	90	3000K	24°	1200lm	800lm	STS2-9302411X-WS	
						40°	1200lm	800lm	STS2-9304011X-WS	
						55°	1200lm	650lm	STS2-9305511X-WS	
						4000K	24°	1300lm	850lm	STS2-9402411X-WS
							40°	1300lm	850lm	STS2-9404011X-WS
							55°	1300lm	700lm	STS2-9405511X-WS

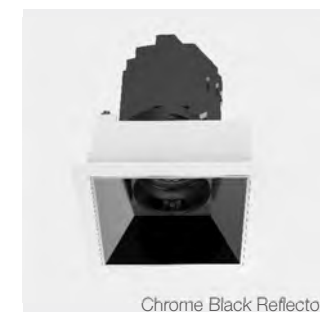

LED Power	System Power	LED Voltage	LED Current	CRI	CCT	Beam	LED Output	System Output	Code	
7.5 W	9 W	31 V	250 mA	90	3000K	24°	900lm	600lm	STS1-9302408X-WC	
						40°	900lm	600lm	STS1-9304008X-WC	
						55°	900lm	500lm	STS1-9305508X-WC	
						4000K	24°	1000lm	650lm	STS1-9402408X-WC
							40°	1000lm	650lm	STS1-9404008X-WC
							55°	1000lm	550lm	STS1-9405508X-WC
11 W	13 W	31 V	350 mA	90	3000K	24°	1200lm	800lm	STS2-9302411X-WC	
						40°	1200lm	800lm	STS2-9304011X-WC	
						55°	1200lm	650lm	STS2-9305511X-WC	
						4000K	24°	1300lm	850lm	STS2-9402411X-WC
							40°	1300lm	850lm	STS2-9404011X-WC
							55°	1300lm	700lm	STS2-9405511X-WC

LED Power	System Power	LED Voltage	LED Current	CRI	CCT	Beam	LED Output	System Output	Code	
7.5 W	9 W	31 V	250 mA	90	3000K	24°	900lm	600lm	STS1-9302408X-WW	
						40°	900lm	600lm	STS1-9304008X-WW	
						55°	900lm	500lm	STS1-9305508X-WW	
						4000K	24°	1000lm	650lm	STS1-9402408X-WW
							40°	1000lm	650lm	STS1-9404008X-WW
							55°	1000lm	550lm	STS1-9405508X-WW
11 W	13 W	31 V	350 mA	90	3000K	24°	1200lm	800lm	STS2-9302411X-WW	
						40°	1200lm	800lm	STS2-9304011X-WW	
						55°	1200lm	650lm	STS2-9305511X-WW	
						4000K	24°	1300lm	850lm	STS2-9402411X-WW
							40°	1300lm	850lm	STS2-9404011X-WW
							55°	1300lm	700lm	STS2-9405511X-WW

LED Power	System Power	LED Voltage	LED Current	CRI	CCT	Beam	LED Output	System Output	Code	
7.5 W	9 W	31 V	250 mA	90	3000K	24°	900lm	600lm	STS1-9302408X-WG	
						40°	900lm	600lm	STS1-9304008X-WG	
						55°	900lm	500lm	STS1-9305508X-WG	
						4000K	24°	1000lm	650lm	STS1-9402408X-WG
							40°	1000lm	650lm	STS1-9404008X-WG
							55°	1000lm	550lm	STS1-9405508X-WG
11 W	13 W	31 V	350 mA	90	3000K	24°	1200lm	800lm	STS2-9302411X-WG	
						40°	1200lm	800lm	STS2-9304011X-WG	
						55°	1200lm	650lm	STS2-9305511X-WG	
						4000K	24°	1300lm	850lm	STS2-9402411X-WG
							40°	1300lm	850lm	STS2-9404011X-WG
							55°	1300lm	700lm	STS2-9405511X-WG

Code Remark: X=F(ON-OFF) X=P(Phase Dim) X=A(1-10V Dim) X=D(DALI Dim)

Trimless Version available



Trimless code for STS1-9302408X-WM → STS3-9302408X-WM  
STS2-9302411X-WM → STS4-9302411X-WM

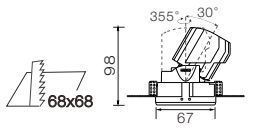

Optional accessory





Code for STS1-9302408X-WM with Honeycomb  
STS1-9302408X-WM-H



**NEKO / SENSE 100 / S100R1**  
Adjustable LED Downlight



13W CRI90 2700K 20° 3000K 40° 4000K 50° CITIZEN 50,000h@L80B10 UGR < 19 IP 20 5 YEAR GUARANTEE CB CE cUL US LISTED

LED Power System Power LED Voltage LED Current CRI CCT Beam LED Output System Output Code											
 Specular Reflector	13 W	15 W	36 V	350 mA	90	2700K	20°	1200lm	800lm	SSR1-9272013X-WS	
							40°	1200lm	800lm	SSR1-9274013X-WS	
							50°	1200lm	800lm	SSR1-9275013X-WS	
						3000K	20°	1300lm	850lm	SSR1-9302013X-WS	
							40°	1300lm	850lm	SSR1-9304013X-WS	
							50°	1300lm	850lm	SSR1-9305013X-WS	
						4000K	20°	1400lm	950lm	SSR1-9402013X-WS	
							40°	1400lm	950lm	SSR1-9404013X-WS	
							50°	1400lm	950lm	SSR1-9405013X-WS	
	 Matt Reflector	13 W	15 W	36 V	350 mA	90	2700K	20°	1200lm	800lm	SSR1-9272013X-WM
								40°	1200lm	800lm	SSR1-9274013X-WM
								50°	1200lm	800lm	SSR1-9275013X-WM
						3000K	20°	1300lm	850lm	SSR1-9302013X-WM	
							40°	1300lm	850lm	SSR1-9304013X-WM	
							50°	1300lm	850lm	SSR1-9305013X-WM	
						4000K	20°	1400lm	950lm	SSR1-9402013X-WM	
							40°	1400lm	950lm	SSR1-9404013X-WM	
							50°	1400lm	950lm	SSR1-9405013X-WM	
 Black Reflector		13 W	15 W	36 V	350 mA	90	2700K	20°	1200lm	800lm	SSR1-9272013X-WB
								40°	1200lm	800lm	SSR1-9274013X-WB
								50°	1200lm	800lm	SSR1-9275013X-WB
						3000K	20°	1300lm	850lm	SSR1-9302013X-WB	
							40°	1300lm	850lm	SSR1-9304013X-WB	
							50°	1300lm	850lm	SSR1-9305013X-WB	
						4000K	20°	1400lm	950lm	SSR1-9402013X-WB	
							40°	1400lm	950lm	SSR1-9404013X-WB	
							50°	1400lm	950lm	SSR1-9405013X-WB	

Code Remark: X=F(ON-OFF) X=P(Phase Dim) X=A(1-10V Dim) X=D(DALI Dim)

Optional accessory

Code for SSR1-9304013X-WM with Honeycomb  
SSR1-9304013X-WM-H



Honeycomb  
HCSR100

LED Power System Power LED Voltage LED Current CRI CCT Beam LED Output System Output Code										
 Chrome Black Reflector	13 W	15 W	36 V	350 mA	90	2700K	20°	1200lm	800lm	SSR1-9272013X-WC
							40°	1200lm	800lm	SSR1-9274013X-WC
							50°	1200lm	800lm	SSR1-9275013X-WC
						3000K	20°	1300lm	850lm	SSR1-9302013X-WC
							40°	1300lm	850lm	SSR1-9304013X-WC
							50°	1300lm	850lm	SSR1-9305013X-WC
						4000K	20°	1400lm	950lm	SSR1-9402013X-WC
							40°	1400lm	950lm	SSR1-9404013X-WC
							50°	1400lm	950lm	SSR1-9405013X-WC

LED Power System Power LED Voltage LED Current CRI CCT Beam LED Output System Output Code										
 White Reflector	13 W	15 W	36 V	350 mA	90	2700K	20°	1200lm	800lm	SSR1-9272013X-WW
							40°	1200lm	800lm	SSR1-9274013X-WW
							50°	1200lm	800lm	SSR1-9275013X-WW
						3000K	20°	1300lm	850lm	SSR1-9302013X-WW
							40°	1300lm	850lm	SSR1-9304013X-WW
							50°	1300lm	850lm	SSR1-9305013X-WW
						4000K	20°	1400lm	950lm	SSR1-9402013X-WW
							40°	1400lm	950lm	SSR1-9404013X-WW
							50°	1400lm	950lm	SSR1-9405013X-WW

LED Power System Power LED Voltage LED Current CRI CCT Beam LED Output System Output Code										
 Gold Reflector	13 W	15 W	36 V	350 mA	90	2700K	20°	1200lm	800lm	SSR1-9272013X-WG
							40°	1200lm	800lm	SSR1-9274013X-WG
							50°	1200lm	800lm	SSR1-9275013X-WG
						3000K	20°	1300lm	850lm	SSR1-9302013X-WG
							40°	1300lm	850lm	SSR1-9304013X-WG
							50°	1300lm	850lm	SSR1-9305013X-WG
						4000K	20°	1400lm	950lm	SSR1-9402013X-WG
							40°	1400lm	950lm	SSR1-9404013X-WG
							50°	1400lm	950lm	SSR1-9405013X-WG

Code Remark: X=F(ON-OFF) X=P(Phase Dim) X=A(1-10V Dim) X=D(DALI Dim)

Trimless Version available

Trimless code for SSR1-9304013X-WM → SSR4-9304013X-WM

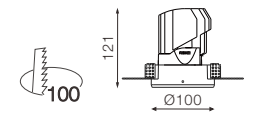





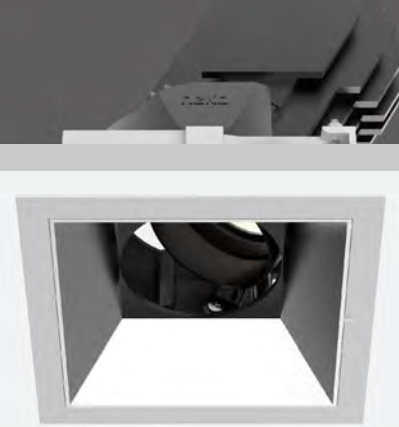

**NEKO / SENSE 100 / S100S1**  
Adjustable LED Downlight

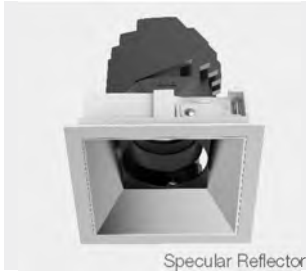

13W CRI90 2700K 20° 40° 50° CITIZEN 50,000h@L80B10 UGR < 19 IP20 5 YEAR WARRANTY CB CE C UL LISTED

LED Power System Power LED Voltage LED Current CRI CCT Beam LED Output System Output Code			
 Specular Reflector	13 W 15 W 36 V 350 mA 90 2700K	20° 1200lm 800lm SSS1-9272013X-WS	
		40° 1200lm 800lm SSS1-9274013X-WS	
		50° 1200lm 800lm SSS1-9275013X-WS	
	3000K	20° 1300lm 850lm SSS1-9302013X-WS	
		40° 1300lm 850lm SSS1-9304013X-WS	
		50° 1300lm 850lm SSS1-9305013X-WS	
	4000K	20° 1400lm 950lm SSS1-9402013X-WS	
		40° 1400lm 950lm SSS1-9404013X-WS	
		50° 1400lm 950lm SSS1-9405013X-WS	
	 Matt Reflector	13 W 15 W 36 V 350 mA 90 2700K	20° 1200lm 800lm SSS1-9272013X-WM
			40° 1200lm 800lm SSS1-9274013X-WM
			50° 1200lm 800lm SSS1-9275013X-WM
3000K		20° 1300lm 850lm SSS1-9302013X-WM	
		40° 1300lm 850lm SSS1-9304013X-WM	
		50° 1300lm 850lm SSS1-9305013X-WM	
4000K		20° 1400lm 950lm SSS1-9402013X-WM	
		40° 1400lm 950lm SSS1-9404013X-WM	
		50° 1400lm 950lm SSS1-9405013X-WM	
 Black Reflector		13 W 15 W 36 V 350 mA 90 2700K	20° 1200lm 800lm SSS1-9272013X-WB
			40° 1200lm 800lm SSS1-9274013X-WB
			50° 1200lm 800lm SSS1-9275013X-WB
	3000K	20° 1300lm 850lm SSS1-9302013X-WB	
		40° 1300lm 850lm SSS1-9304013X-WB	
		50° 1300lm 850lm SSS1-9305013X-WB	
	4000K	20° 1400lm 950lm SSS1-9402013X-WB	
		40° 1400lm 950lm SSS1-9404013X-WB	
		50° 1400lm 950lm SSS1-9405013X-WB	

Code Remark: X=F(ON-OFF) X=P(Phase Dim) X=A(1-10V Dim) X=D(DALI Dim)

Optional accessory

Code for SSS1-9304013X-WM with Honeycomb  
SSS1-9304013X-WM-H

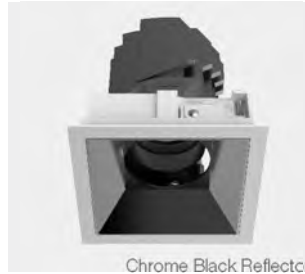
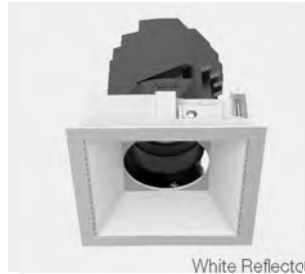
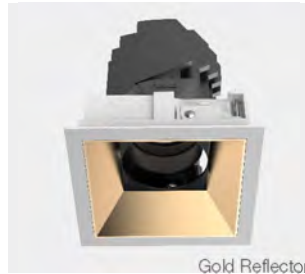

Honeycomb HCSR100

LED Power System Power LED Voltage LED Current CRI CCT Beam LED Output System Output Code			
 Chrome Black Reflector	13 W 15 W 36 V 350 mA 90 2700K	20° 1200lm 800lm SSS1-9272013X-WC	
		40° 1200lm 800lm SSS1-9274013X-WC	
		50° 1200lm 800lm SSS1-9275013X-WC	
	3000K	20° 1300lm 850lm SSS1-9302013X-WC	
		40° 1300lm 850lm SSS1-9304013X-WC	
		50° 1300lm 850lm SSS1-9305013X-WC	
	4000K	20° 1400lm 950lm SSS1-9402013X-WC	
		40° 1400lm 950lm SSS1-9404013X-WC	
		50° 1400lm 950lm SSS1-9405013X-WC	
	 White Reflector	13 W 15 W 36 V 350 mA 90 2700K	20° 1200lm 800lm SSS1-9272013X-WW
			40° 1200lm 800lm SSS1-9274013X-WW
			50° 1200lm 800lm SSS1-9275013X-WW
3000K		20° 1300lm 850lm SSS1-9302013X-WW	
		40° 1300lm 850lm SSS1-9304013X-WW	
		50° 1300lm 850lm SSS1-9305013X-WW	
4000K		20° 1400lm 950lm SSS1-9402013X-WW	
		40° 1400lm 950lm SSS1-9404013X-WW	
		50° 1400lm 950lm SSS1-9405013X-WW	
 Gold Reflector		13 W 15 W 36 V 350 mA 90 2700K	20° 1200lm 800lm SSS1-9272013X-WG
			40° 1200lm 800lm SSS1-9274013X-WG
			50° 1200lm 800lm SSS1-9275013X-WG
	3000K	20° 1300lm 850lm SSS1-9302013X-WG	
		40° 1300lm 850lm SSS1-9304013X-WG	
		50° 1300lm 850lm SSS1-9305013X-WG	
	4000K	20° 1400lm 950lm SSS1-9402013X-WG	
		40° 1400lm 950lm SSS1-9404013X-WG	
		50° 1400lm 950lm SSS1-9405013X-WG	

Code Remark: X=F(ON-OFF) X=P(Phase Dim) X=A(1-10V Dim) X=D(DALI Dim)

Trimless Version available

Trimless code for SSS1-9304013X-WM → SSS4-9304013X-WM

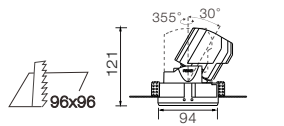





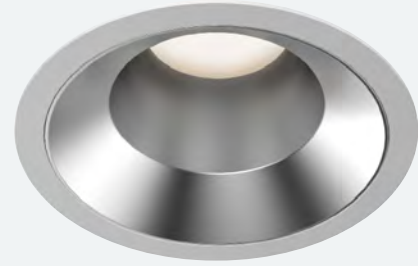



**NEKO / SENSE 100 / S100R2**  
Fixed LED Downlight



13W	CRI90	2700K 3000K 4000K	28° 35° 50°	<b>CITIZEN</b> 50,000h@L80B10	UGR < 19	IP 20	5 YEAR WARRANTY	CB	CE	UL LISTED	100	1-25mm Ceiling Thickness	121	Ø110
-----	-------	-------------------------	-------------------	----------------------------------	----------	-------	-----------------	----	----	-----------	-----	--------------------------	-----	------

LED Power System Power LED Voltage LED Current CRI CCT Beam LED Output System Output Code											
 Specular Reflector	13 W	15 W	36 V	350 mA	90	2700K	28°	1200lm	850lm	SSR2-9272813X-WS	
							35°	1200lm	850lm	SSR2-9273513X-WS	
							50°	1200lm	850lm	SSR2-9275013X-WS	
	3000K	28°	1300lm	900lm	SSR2-9302813X-WS						
		35°	1300lm	900lm	SSR2-9303513X-WS						
		50°	1300lm	900lm	SSR2-9305013X-WS						
	4000K	28°	1400lm	1000lm	SSR2-9402813X-WS						
		35°	1400lm	1000lm	SSR2-9403513X-WS						
		50°	1400lm	1000lm	SSR2-9405013X-WS						
	 Matt Reflector	13 W	15 W	36 V	350 mA	90	2700K	28°	1200lm	850lm	SSR2-9272813X-WM
								35°	1200lm	850lm	SSR2-9273513X-WM
								50°	1200lm	850lm	SSR2-9275013X-WM
3000K		28°	1300lm	900lm	SSR2-9302813X-WM						
		35°	1300lm	900lm	SSR2-9303513X-WM						
		50°	1300lm	900lm	SSR2-9305013X-WM						
4000K		28°	1400lm	1000lm	SSR2-9402813X-WM						
		35°	1400lm	1000lm	SSR2-9403513X-WM						
		50°	1400lm	1000lm	SSR2-9405013X-WM						
 Black Reflector		13 W	15 W	36 V	350 mA	90	2700K	28°	1200lm	850lm	SSR2-9272813X-WB
								35°	1200lm	850lm	SSR2-9273513X-WB
								50°	1200lm	850lm	SSR2-9275013X-WB
	3000K	28°	1300lm	900lm	SSR2-9302813X-WB						
		35°	1300lm	900lm	SSR2-9303513X-WB						
		50°	1300lm	900lm	SSR2-9305013X-WB						
	4000K	28°	1400lm	1000lm	SSR2-9402813X-WB						
		35°	1400lm	1000lm	SSR2-9403513X-WB						
		50°	1400lm	1000lm	SSR2-9405013X-WB						

Code Remark: X=F(ON-OFF) X=P(Phase Dim) X=A(1-10V Dim) X=D(DALI Dim)

LED Power System Power LED Voltage LED Current CRI CCT Beam LED Output System Output Code											
 Chrome Black Reflector	13 W	15 W	36 V	350 mA	90	2700K	28°	1200lm	850lm	SSR2-9272813X-WC	
							35°	1200lm	850lm	SSR2-9273513X-WC	
							50°	1200lm	850lm	SSR2-9275013X-WC	
	3000K	28°	1300lm	900lm	SSR2-9302813X-WC						
		35°	1300lm	900lm	SSR2-9303513X-WC						
		50°	1300lm	900lm	SSR2-9305013X-WC						
	4000K	28°	1400lm	1000lm	SSR2-9402813X-WC						
		35°	1400lm	1000lm	SSR2-9403513X-WC						
		50°	1400lm	1000lm	SSR2-9405013X-WC						
	 White Reflector	13 W	15 W	36 V	350 mA	90	2700K	28°	1200lm	850lm	SSR2-9272813X-WW
								35°	1200lm	850lm	SSR2-9273513X-WW
								50°	1200lm	850lm	SSR2-9275013X-WW
3000K		28°	1300lm	900lm	SSR2-9302813X-WW						
		35°	1300lm	900lm	SSR2-9303513X-WW						
		50°	1300lm	900lm	SSR2-9305013X-WW						
4000K		28°	1400lm	1000lm	SSR2-9402813X-WW						
		35°	1400lm	1000lm	SSR2-9403513X-WW						
		50°	1400lm	1000lm	SSR2-9405013X-WW						
 Gold Reflector		13 W	15 W	36 V	350 mA	90	2700K	28°	1200lm	850lm	SSR2-9272813X-WG
								35°	1200lm	850lm	SSR2-9273513X-WG
								50°	1200lm	850lm	SSR2-9275013X-WG
	3000K	28°	1300lm	900lm	SSR2-9302813X-WG						
		35°	1300lm	900lm	SSR2-9303513X-WG						
		50°	1300lm	900lm	SSR2-9305013X-WG						
	4000K	28°	1400lm	1000lm	SSR2-9402813X-WG						
		35°	1400lm	1000lm	SSR2-9403513X-WG						
		50°	1400lm	1000lm	SSR2-9405013X-WG						

Code Remark: X=F(ON-OFF) X=P(Phase Dim) X=A(1-10V Dim) X=D(DALI Dim)

Trimless Version available



Trimless code for SSR2-9303513X-WM → SSR5-9303513X-WM

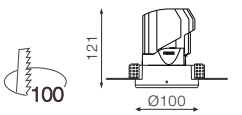



NEKO / SENSE 100 / S100S2  
Fixed LED Downlight

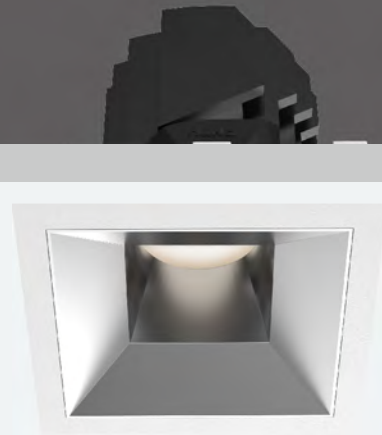

LED Power	System Power	LED Voltage	LED Current	CRI	CCT	Beam	LED Output	System Output	Code						
13 W	15 W	36 V	350 mA	90	2700K	28°	1200lm	850lm	SSS2-9272813X-WS						
						35°	1200lm	850lm	SSS2-9273513X-WS						
						50°	1200lm	850lm	SSS2-9275013X-WS						
						3000K	28°	1300lm	900lm	SSS2-9302813X-WS					
							35°	1300lm	900lm	SSS2-9303513X-WS					
							50°	1300lm	900lm	SSS2-9305013X-WS					
						4000K	28°	1400lm	1000lm	SSS2-9402813X-WS					
							35°	1400lm	1000lm	SSS2-9403513X-WS					
							50°	1400lm	1000lm	SSS2-9405013X-WS					
						13 W	15 W	36 V	350 mA	90	2700K	28°	1200lm	850lm	SSS2-9272813X-WM
												35°	1200lm	850lm	SSS2-9273513X-WM
												50°	1200lm	850lm	SSS2-9275013X-WM
3000K	28°	1300lm	900lm	SSS2-9302813X-WM											
	35°	1300lm	900lm	SSS2-9303513X-WM											
	50°	1300lm	900lm	SSS2-9305013X-WM											
4000K	28°	1400lm	1000lm	SSS2-9402813X-WM											
	35°	1400lm	1000lm	SSS2-9403513X-WM											
	50°	1400lm	1000lm	SSS2-9405013X-WM											
13 W	15 W	36 V	350 mA	90	2700K							28°	1200lm	850lm	SSS2-9272813X-WB
												35°	1200lm	850lm	SSS2-9273513X-WB
												50°	1200lm	850lm	SSS2-9275013X-WB
						3000K	28°	1300lm	900lm	SSS2-9302813X-WB					
							35°	1300lm	900lm	SSS2-9303513X-WB					
							50°	1300lm	900lm	SSS2-9305013X-WB					
						4000K	28°	1400lm	1000lm	SSS2-9402813X-WB					
							35°	1400lm	1000lm	SSS2-9403513X-WB					
							50°	1400lm	1000lm	SSS2-9405013X-WB					

Code Remark: X=F(ON-OFF) X=P(Phase Dim) X=A(1-10V Dim) X=D(DALI Dim)

LED Power	System Power	LED Voltage	LED Current	CRI	CCT	Beam	LED Output	System Output	Code						
13 W	15 W	36 V	350 mA	90	2700K	28°	1200lm	850lm	SSS2-9272813X-WC						
						35°	1200lm	850lm	SSS2-9273513X-WC						
						50°	1200lm	850lm	SSS2-9275013X-WC						
						3000K	28°	1300lm	900lm	SSS2-9302813X-WC					
							35°	1300lm	900lm	SSS2-9303513X-WC					
							50°	1300lm	900lm	SSS2-9305013X-WC					
						4000K	28°	1400lm	1000lm	SSS2-9402813X-WC					
							35°	1400lm	1000lm	SSS2-9403513X-WC					
							50°	1400lm	1000lm	SSS2-9405013X-WC					
						13 W	15 W	36 V	350 mA	90	2700K	28°	1200lm	850lm	SSS2-9272813X-WW
												35°	1200lm	850lm	SSS2-9273513X-WW
												50°	1200lm	850lm	SSS2-9275013X-WW
3000K	28°	1300lm	900lm	SSS2-9302813X-WW											
	35°	1300lm	900lm	SSS2-9303513X-WW											
	50°	1300lm	900lm	SSS2-9305013X-WW											
4000K	28°	1400lm	1000lm	SSS2-9402813X-WW											
	35°	1400lm	1000lm	SSS2-9403513X-WW											
	50°	1400lm	1000lm	SSS2-9405013X-WW											
13 W	15 W	36 V	350 mA	90	2700K							28°	1200lm	850lm	SSS2-9272813X-WG
												35°	1200lm	850lm	SSS2-9273513X-WG
												50°	1200lm	850lm	SSS2-9275013X-WG
						3000K	28°	1300lm	900lm	SSS2-9302813X-WG					
							35°	1300lm	900lm	SSS2-9303513X-WG					
							50°	1300lm	900lm	SSS2-9305013X-WG					
						4000K	28°	1400lm	1000lm	SSS2-9402813X-WG					
							35°	1400lm	1000lm	SSS2-9403513X-WG					
							50°	1400lm	1000lm	SSS2-9405013X-WG					

Code Remark: X=F(ON-OFF) X=P(Phase Dim) X=A(1-10V Dim) X=D(DALI Dim)

Trimless Version available



Trimless code for SSS2-9303513X-WM → SSS5-9303513X-WM

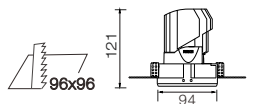



**NEKO / SENSE**  
Wall Washer LED Downlight

**NEKO / SENSE 100 / S100R3**  
Wall Washer LED Downlight

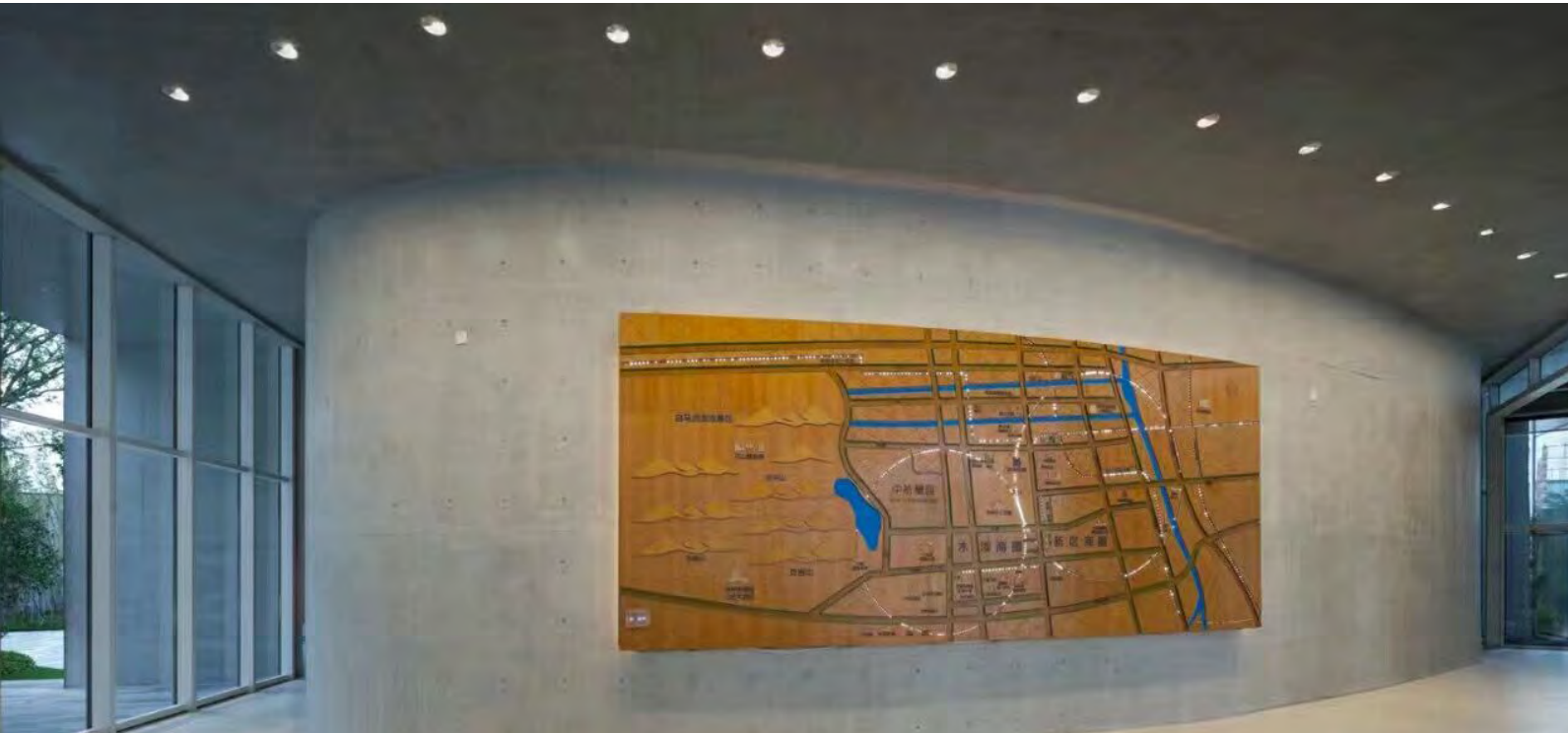

13W CRI90 CRI80 2700K 3000K 4000K CITIZEN 50,000h@L80B10 UGR < 19 IP 20 5 YEAR GUARANTEE CB CE cUL US LISTED

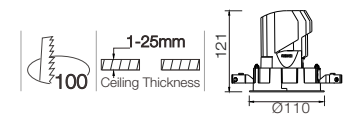

LED Power	System power	LED Voltage	LED Current	CRI	CCT	Beam	LED Output	System Output	Code
13 W	15 W	36 V	350 mA	80	2700K	Wall Washer	1300lm	500lm	SSR3-827WW13X-WM
						Wall Washer	1400lm	550lm	SSR3-830WW13X-WM
						Wall Washer	1500lm	600lm	SSR3-840WW13X-WM
90					2700K	Wall Washer	1200lm	450lm	SSR3-927WW13X-WM
						Wall Washer	1300lm	480lm	SSR3-930WW13X-WM
						Wall Washer	1400lm	550lm	SSR3-940WW13X-WM

Code Remark: X=F(ON-OFF) X=P(Phase Dim) X=A(1-10V Dim) X=D(DALI Dim)

Trimless Version available



Trimless code for SSR3-930WW13X-WM → SSR6-930WW13X-WM

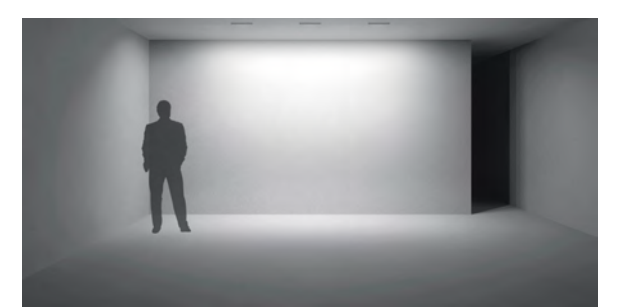
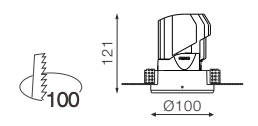

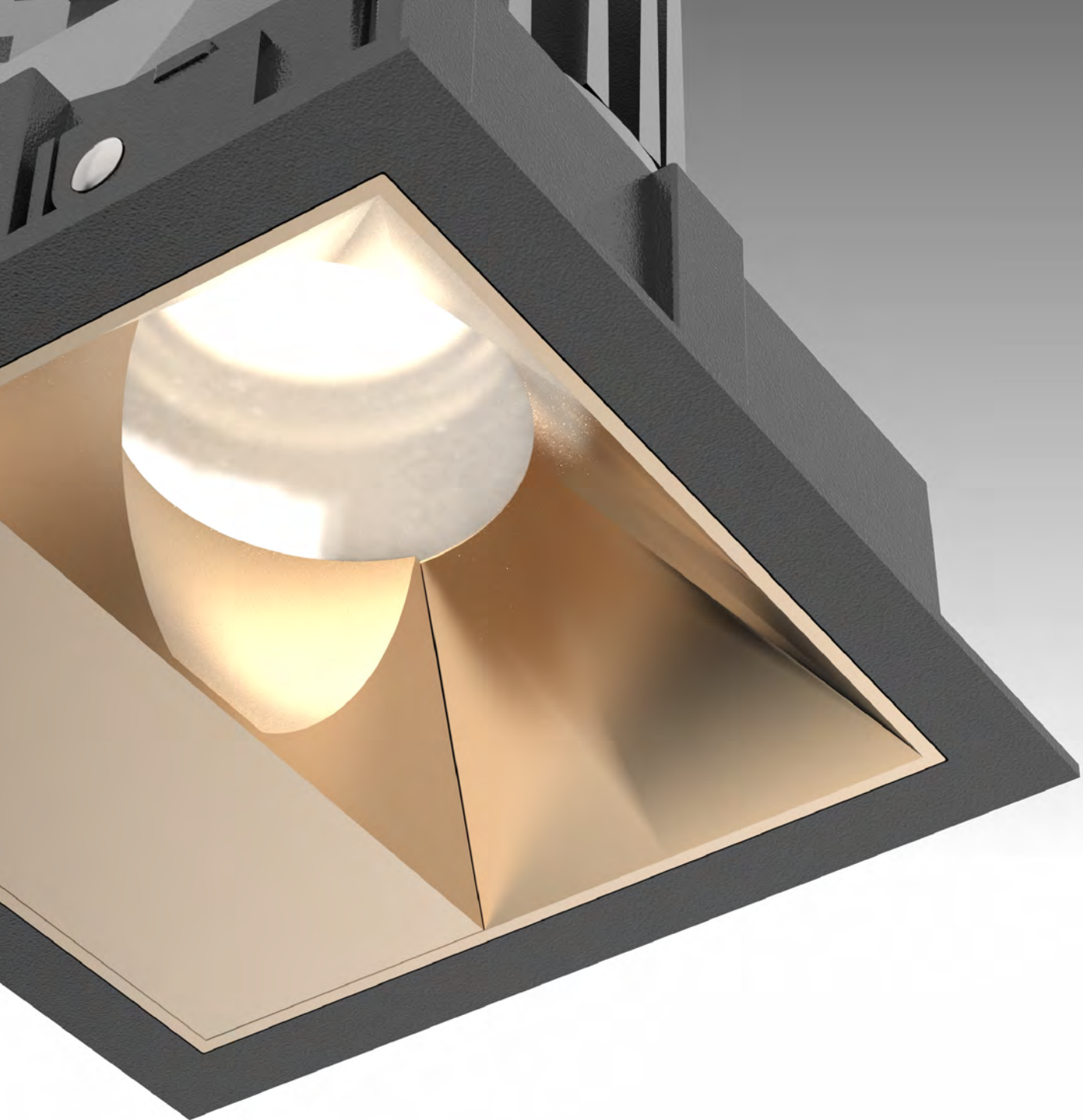

**NEKO / SENSE 100 / S100S3**  
Wall Washer LED Downlight

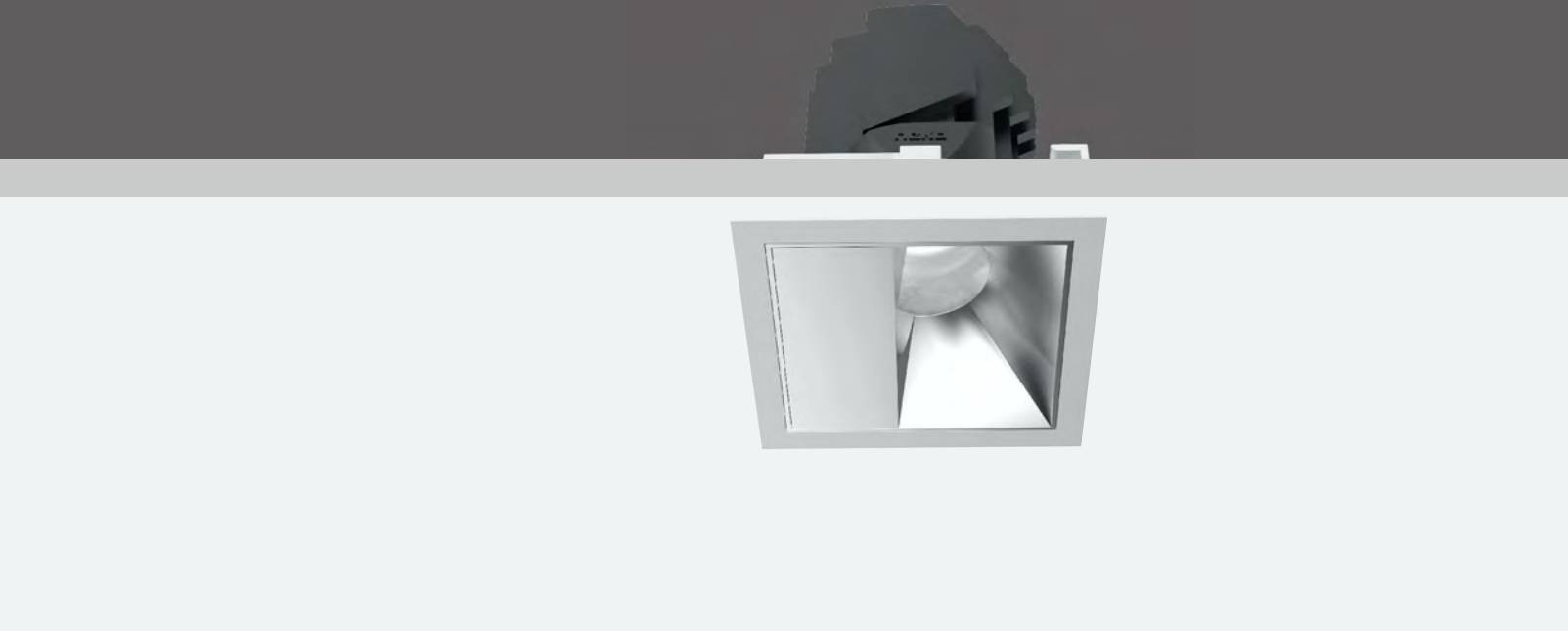

13W CRI90 CRI80 2700K 3000K 4000K  
 CITIZEN 50,000h@L80B10 UGR < 19 IP 20 5 YEAR GUARANTEE CB CE cUL US LISTED  
 96x96 1-25mm Ceiling Thickness 121 107x107

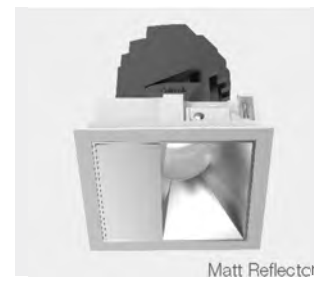

LED Power	System power	LED Voltage	LED Current	CRI	CCT	Beam	LED Output	System Output	Code
13 W	15 W	36 V	350 mA	80	2700K	Wall Washer	1300lm	500lm	SSS3-827WW13X-WM
						3000K Wall Washer	1400lm	550lm	SSS3-830WW13X-WM
						4000K Wall Washer	1500lm	600lm	SSS3-840WW13X-WM
90					2700K	Wall Washer	1200lm	450lm	SSS3-927WW13X-WM
						3000K Wall Washer	1300lm	480lm	SSS3-930WW13X-WM
						4000K Wall Washer	1400lm	550lm	SSS3-940WW13X-WM

Code Remark: X=F(ON-OFF) X=P(Phase Dim) X=A(1-10V Dim) X=D(DALI Dim)

Trimless Version available



Trimless code for SSS3-930WW13X-WM → SSS6-930WW13X-WM

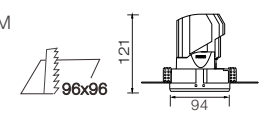



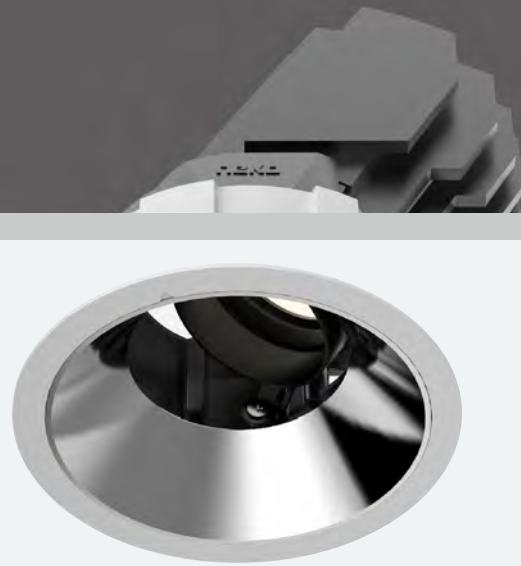

**NEKO / SENSE 125 / S125R1**  
Adjustable LED Downlight



18W CRI90 2700K 3000K 4000K 20° 40° 50° CITIZEN 50,000h@L80B10 UGR < 19 IP 20 5 YEAR WARRANTY CB CE cUL US LISTED 125 1-30mm Ceiling Thickness 162 355 137 30°

LED Power System Power LED Voltage LED Current CRI CCT Beam LED Output System Output Code											
 <p>Specular Reflector</p>	18 W	21 W	36 V	500 mA	90	2700K	20°	1800lm	1200lm	SMR1-9272018X-WS	
							40°	1800lm	1200lm	SMR1-9274018X-WS	
							50°	1800lm	1200lm	SMR1-9275018X-WS	
						3000K	20°	2000lm	1300lm	SMR1-9302018X-WS	
							40°	2000lm	1300lm	SMR1-9304018X-WS	
							50°	2000lm	1300lm	SMR1-9305018X-WS	
						4000K	20°	2200lm	1400lm	SMR1-9402018X-WS	
							40°	2200lm	1400lm	SMR1-9404018X-WS	
							50°	2200lm	1400lm	SMR1-9405018X-WS	
	 <p>Matt Reflector</p>	18 W	21 W	36 V	500 mA	90	2700K	20°	1800lm	1200lm	SMR1-9272018X-WM
								40°	1800lm	1200lm	SMR1-9274018X-WM
								50°	1800lm	1200lm	SMR1-9275018X-WM
						3000K	20°	2000lm	1300lm	SMR1-9302018X-WM	
							40°	2000lm	1300lm	SMR1-9304018X-WM	
							50°	2000lm	1300lm	SMR1-9305018X-WM	
						4000K	20°	2200lm	1400lm	SMR1-9402018X-WM	
							40°	2200lm	1400lm	SMR1-9404018X-WM	
							50°	2200lm	1400lm	SMR1-9405018X-WM	
 <p>Black Reflector</p>		18 W	21 W	36 V	500 mA	90	2700K	20°	1800lm	1200lm	SMR1-9272018X-WB
								40°	1800lm	1200lm	SMR1-9274018X-WB
								50°	1800lm	1200lm	SMR1-9275018X-WB
						3000K	20°	2000lm	1300lm	SMR1-9302018X-WB	
							40°	2000lm	1300lm	SMR1-9304018X-WB	
							50°	2000lm	1300lm	SMR1-9305018X-WB	
						4000K	20°	2200lm	1400lm	SMR1-9402018X-WB	
							40°	2200lm	1400lm	SMR1-9404018X-WB	
							50°	2200lm	1400lm	SMR1-9405018X-WB	

Code Remark: X=F(ON-OFF) X=P(Phase Dim) X=A(1-10V Dim) X=D(DALI Dim)



Optional accessory

Code for SMR1-9304018X-WM with Honeycomb  
SMR1-9304018X-WM-H



Honeycomb  
HCSR125



LED Power System Power LED Voltage LED Current CRI CCT Beam LED Output System Output Code											
 <p>Chrome Black Reflector</p>	18 W	21 W	36 V	500 mA	90	2700K	20°	1800lm	1200lm	SMR1-9272018X-WC	
							40°	1800lm	1200lm	SMR1-9274018X-WC	
							50°	1800lm	1200lm	SMR1-9275018X-WC	
						3000K	20°	2000lm	1300lm	SMR1-9302018X-WC	
							40°	2000lm	1300lm	SMR1-9304018X-WC	
							50°	2000lm	1300lm	SMR1-9305018X-WC	
						4000K	20°	2200lm	1400lm	SMR1-9402018X-WC	
							40°	2200lm	1400lm	SMR1-9404018X-WC	
							50°	2200lm	1400lm	SMR1-9405018X-WC	
	 <p>White Reflector</p>	18 W	21 W	36 V	500 mA	90	2700K	20°	1800lm	1200lm	SMR1-9272018X-WW
								40°	1800lm	1200lm	SMR1-9274018X-WW
								50°	1800lm	1200lm	SMR1-9275018X-WW
						3000K	20°	2000lm	1300lm	SMR1-9302018X-WW	
							40°	2000lm	1300lm	SMR1-9304018X-WW	
							50°	2000lm	1300lm	SMR1-9305018X-WW	
						4000K	20°	2200lm	1400lm	SMR1-9402018X-WW	
							40°	2200lm	1400lm	SMR1-9404018X-WW	
							50°	2200lm	1400lm	SMR1-9405018X-WW	
 <p>Gold Reflector</p>		18 W	21 W	36 V	500 mA	90	2700K	20°	1800lm	1200lm	SMR1-9272018X-WG
								40°	1800lm	1200lm	SMR1-9274018X-WG
								50°	1800lm	1200lm	SMR1-9275018X-WG
						3000K	20°	2000lm	1300lm	SMR1-9302018X-WG	
							40°	2000lm	1300lm	SMR1-9304018X-WG	
							50°	2000lm	1300lm	SMR1-9305018X-WG	
						4000K	20°	2200lm	1400lm	SMR1-9402018X-WG	
							40°	2200lm	1400lm	SMR1-9404018X-WG	
							50°	2200lm	1400lm	SMR1-9405018X-WG	

Code Remark: X=F(ON-OFF) X=P(Phase Dim) X=A(1-10V Dim) X=D(DALI Dim)

Trimless Version available

Trimless code for SMR1-9304018X-WM → SMR4-9304018X-WM

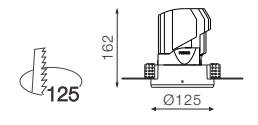





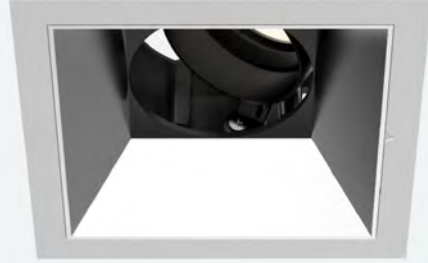

**NEKO / SENSE 125 / S125S1**  
Adjustable LED Downlight

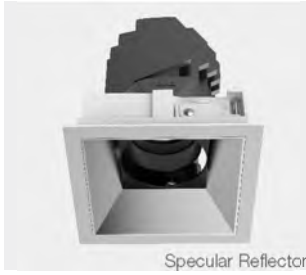

18W CRI90 2700K 20° 3000K 40° 4000K 50° CITIZEN 50,000h@L80B10 UGR < 19 IP 20 5 YEAR WARRANTY CB CE cUL US LISTED



LED Power System Power LED Voltage LED Current CRI CCT Beam LED Output System Output Code			
 Specular Reflector	18 W 21 W 36 V 500 mA 90 2700K	20° 1800lm 1200lm SMS1-9272018X-WS	
		40° 1800lm 1200lm SMS1-9274018X-WS	
		50° 1800lm 1200lm SMS1-9275018X-WS	
	3000K	20° 2000lm 1300lm SMS1-9302018X-WS	
		40° 2000lm 1300lm SMS1-9304018X-WS	
		50° 2000lm 1300lm SMS1-9305018X-WS	
	4000K	20° 2200lm 1400lm SMS1-9402018X-WS	
		40° 2200lm 1400lm SMS1-9404018X-WS	
		50° 2200lm 1400lm SMS1-9405018X-WS	
	 White Reflector	18 W 21 W 36 V 500 mA 90 2700K	20° 1800lm 1200lm SMS1-9272018X-WM
			40° 1800lm 1200lm SMS1-9274018X-WM
			50° 1800lm 1200lm SMS1-9275018X-WM
3000K		20° 2000lm 1300lm SMS1-9302018X-WM	
		40° 2000lm 1300lm SMS1-9304018X-WM	
		50° 2000lm 1300lm SMS1-9305018X-WM	
4000K		20° 2200lm 1400lm SMS1-9402018X-WM	
		40° 2200lm 1400lm SMS1-9404018X-WM	
		50° 2200lm 1400lm SMS1-9405018X-WM	
 Gold Reflector		18 W 21 W 36 V 500 mA 90 2700K	20° 1800lm 1200lm SMS1-9272018X-WB
			40° 1800lm 1200lm SMS1-9274018X-WB
			50° 1800lm 1200lm SMS1-9275018X-WB
	3000K	20° 2000lm 1300lm SMS1-9302018X-WB	
		40° 2000lm 1300lm SMS1-9304018X-WB	
		50° 2000lm 1300lm SMS1-9305018X-WB	
	4000K	20° 2200lm 1400lm SMS1-9402018X-WB	
		40° 2200lm 1400lm SMS1-9404018X-WB	
		50° 2200lm 1400lm SMS1-9405018X-WB	

Code Remark: X=F(ON-OFF) X=P(Phase Dim) X=A(1-10V Dim) X=D(DALI Dim)

Optional accessory

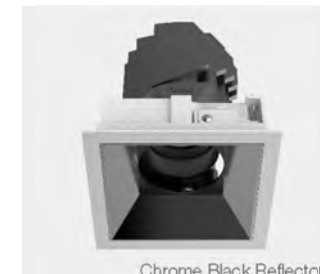
Code for SMS1-9304018X-WM with Honeycomb  
SMS1-9304018X-WM-H

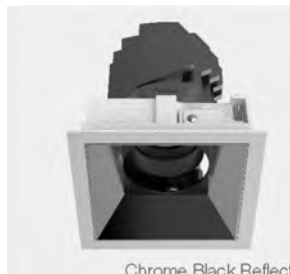



LED Power System Power LED Voltage LED Current CRI CCT Beam LED Output System Output Code			
 Chrome Black Reflector	18 W 21 W 36 V 500 mA 90 2700K	20° 1800lm 1200lm SMS1-9272018X-WC	
		40° 1800lm 1200lm SMS1-9274018X-WC	
		50° 1800lm 1200lm SMS1-9275018X-WC	
	3000K	20° 2000lm 1300lm SMS1-9302018X-WC	
		40° 2000lm 1300lm SMS1-9304018X-WC	
		50° 2000lm 1300lm SMS1-9305018X-WC	
	4000K	20° 2200lm 1400lm SMS1-9402018X-WC	
		40° 2200lm 1400lm SMS1-9404018X-WC	
		50° 2200lm 1400lm SMS1-9405018X-WC	
	 White Reflector	18 W 21 W 36 V 500 mA 90 2700K	20° 1800lm 1200lm SMS1-9272018X-WW
			40° 1800lm 1200lm SMS1-9274018X-WW
			50° 1800lm 1200lm SMS1-9275018X-WW
3000K		20° 2000lm 1300lm SMS1-9302018X-WW	
		40° 2000lm 1300lm SMS1-9304018X-WW	
		50° 2000lm 1300lm SMS1-9305018X-WW	
4000K		20° 2200lm 1400lm SMS1-9402018X-WW	
		40° 2200lm 1400lm SMS1-9404018X-WW	
		50° 2200lm 1400lm SMS1-9405018X-WW	
 Gold Reflector		18 W 21 W 36 V 500 mA 90 2700K	20° 1800lm 1200lm SMS1-9272018X-WG
			40° 1800lm 1200lm SMS1-9274018X-WG
			50° 1800lm 1200lm SMS1-9275018X-WG
	3000K	20° 2000lm 1300lm SMS1-9302018X-WG	
		40° 2000lm 1300lm SMS1-9304018X-WG	
		50° 2000lm 1300lm SMS1-9305018X-WG	
	4000K	20° 2200lm 1400lm SMS1-9402018X-WG	
		40° 2200lm 1400lm SMS1-9404018X-WG	
		50° 2200lm 1400lm SMS1-9405018X-WG	

Code Remark: X=F(ON-OFF) X=P(Phase Dim) X=A(1-10V Dim) X=D(DALI Dim)

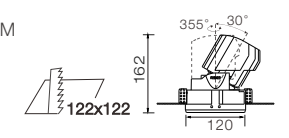

Trimless Version available

Trimless code for SMS1-9304018X-WM → SMS4-9304018X-WM

**NEKO / SENSE 125 / S125R2**  
Fixed LED Downlight

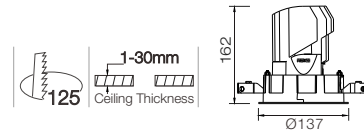

	LED Power	System Power	LED Voltage	LED Current	CRI	CCT	Beam	LED Output	System Output	Code	
	18 W	21 W	36 V	500 mA	90	2700K	28°	1800lm	1300lm	SMR2-9272818X-WS	
							40°	1800lm	1300lm	SMR2-9274018X-WS	
							50°	1800lm	1300lm	SMR2-9275018X-WS	
		3000K	28°	2000lm	1400lm	SMR2-9302818X-WS					
			40°	2000lm	1400lm	SMR2-9304018X-WS					
			50°	2000lm	1400lm	SMR2-9305018X-WS					
		4000K	28°	2200lm	1500lm	SMR2-9402818X-WS					
			40°	2200lm	1500lm	SMR2-9404018X-WS					
			50°	2200lm	1500lm	SMR2-9405018X-WS					
		18 W	21 W	36 V	500 mA	90	2700K	28°	1800lm	1300lm	SMR2-9272818X-WM
								40°	1800lm	1300lm	SMR2-9274018X-WM
								50°	1800lm	1300lm	SMR2-9275018X-WM
		3000K	28°	2000lm	1400lm	SMR2-9302818X-WM					
			40°	2000lm	1400lm	SMR2-9304018X-WM					
			50°	2000lm	1400lm	SMR2-9305018X-WM					
		4000K	28°	2200lm	1500lm	SMR2-9402818X-WM					
			40°	2200lm	1500lm	SMR2-9404018X-WM					
			50°	2200lm	1500lm	SMR2-9405018X-WM					
		18 W	21 W	36 V	500 mA	90	2700K	28°	1800lm	1300lm	SMR2-9272818X-WB
								40°	1800lm	1300lm	SMR2-9274018X-WB
								50°	1800lm	1300lm	SMR2-9275018X-WB
		3000K	28°	2000lm	1400lm	SMR2-9302818X-WB					
			40°	2000lm	1400lm	SMR2-9304018X-WB					
			50°	2000lm	1400lm	SMR2-9305018X-WB					
		4000K	28°	2200lm	1500lm	SMR2-9402818X-WB					
			40°	2200lm	1500lm	SMR2-9404018X-WB					
			50°	2200lm	1500lm	SMR2-9405018X-WB					

Code Remark: X=F(ON-OFF) X=P(Phase Dim) X=A(1-10V Dim) X=D(DALI Dim)

LED Power	System Power	LED Voltage	LED Current	CRI	CCT	Beam	LED Output	System Output	Code	
18 W	21 W	36 V	500 mA	90	2700K	28°	1800lm	1300lm	SMR2-9272818X-WC	
						40°	1800lm	1300lm	SMR2-9274018X-WC	
						50°	1800lm	1300lm	SMR2-9275018X-WC	
						3000K	28°	2000lm	1400lm	SMR2-9302818X-WC
							40°	2000lm	1400lm	SMR2-9304018X-WC
							50°	2000lm	1400lm	SMR2-9305018X-WC
						4000K	28°	2200lm	1500lm	SMR2-9402818X-WC
							40°	2200lm	1500lm	SMR2-9404018X-WC
							50°	2200lm	1500lm	SMR2-9405018X-WC



LED Power	System Power	LED Voltage	LED Current	CRI	CCT	Beam	LED Output	System Output	Code	
18 W	21 W	36 V	500 mA	90	2700K	28°	1800lm	1300lm	SMR2-9272818X-WW	
						40°	1800lm	1300lm	SMR2-9274018X-WW	
						50°	1800lm	1300lm	SMR2-9275018X-WW	
						3000K	28°	2000lm	1400lm	SMR2-9302818X-WW
							40°	2000lm	1400lm	SMR2-9304018X-WW
							50°	2000lm	1400lm	SMR2-9305018X-WW
						4000K	28°	2200lm	1500lm	SMR2-9402818X-WW
							40°	2200lm	1500lm	SMR2-9404018X-WW
							50°	2200lm	1500lm	SMR2-9405018X-WW



LED Power	System Power	LED Voltage	LED Current	CRI	CCT	Beam	LED Output	System Output	Code	
18 W	21 W	36 V	500 mA	90	2700K	28°	1800lm	1300lm	SMR2-9272818X-WG	
						40°	1800lm	1300lm	SMR2-9274018X-WG	
						50°	1800lm	1300lm	SMR2-9275018X-WG	
						3000K	28°	2000lm	1400lm	SMR2-9302818X-WG
							40°	2000lm	1400lm	SMR2-9304018X-WG
							50°	2000lm	1400lm	SMR2-9305018X-WG
						4000K	28°	2200lm	1500lm	SMR2-9402818X-WG
							40°	2200lm	1500lm	SMR2-9404018X-WG
							50°	2200lm	1500lm	SMR2-9405018X-WG



Code Remark: X=F(ON-OFF) X=P(Phase Dim) X=A(1-10V Dim) X=D(DALI Dim)

Trimless Version available



Trimless code for SMR2-9304018X-WM → SMR5-9304018X-WM

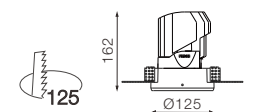





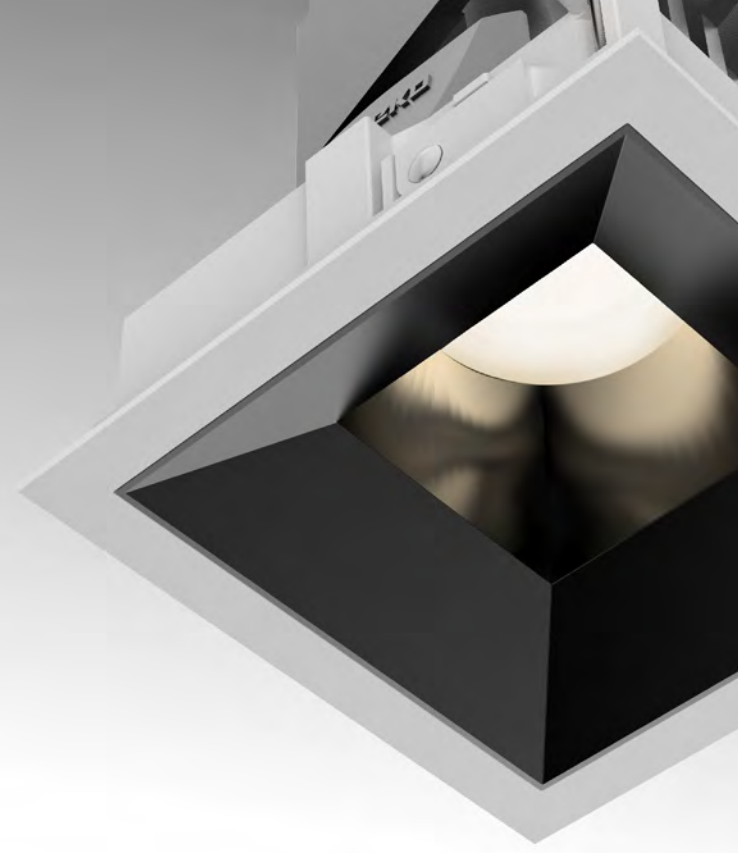
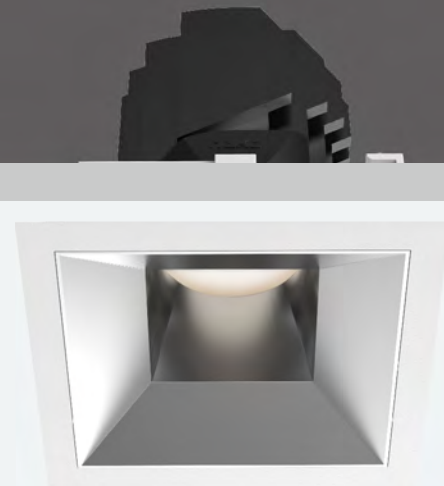

**NEKO / SENSE 125 / S125S2**  
Fixed LED Downlight

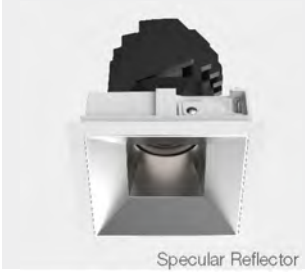

18W CRI90 2700K 28° 3000K 40° 4000K 50° CITIZEN 50,000h@L80B10 UGR < 19 IP20 5 YEAR WARRANTY CB CE C-UL US LISTED

LED Power System Power LED Voltage LED Current CRI CCT Beam LED Output System Output Code						
 Specular Reflector	18 W 21 W 36 V 500 mA 90 2700K	28°	1800lm	1300lm	SMS2-9272818X-WC	
		40°	1800lm	1300lm	SMS2-9274018X-WC	
		50°	1800lm	1300lm	SMS2-9275018X-WC	
	3000K	28°	2000lm	1400lm	SMS2-9302818X-WC	
		40°	2000lm	1400lm	SMS2-9304018X-WC	
		50°	2000lm	1400lm	SMS2-9305018X-WC	
	4000K	28°	2200lm	1500lm	SMS2-9402818X-WC	
		40°	2200lm	1500lm	SMS2-9404018X-WC	
		50°	2200lm	1500lm	SMS2-9405018X-WC	
	 Matt Reflector	18 W 21 W 36 V 500 mA 90 2700K	28°	1800lm	1300lm	SMS2-9272818X-WM
			40°	1800lm	1300lm	SMS2-9274018X-WM
			50°	1800lm	1300lm	SMS2-9275018X-WM
3000K		28°	2000lm	1400lm	SMS2-9302818X-WM	
		40°	2000lm	1400lm	SMS2-9304018X-WM	
		50°	2000lm	1400lm	SMS2-9305018X-WM	
4000K		28°	2200lm	1500lm	SMS2-9402818X-WM	
		40°	2200lm	1500lm	SMS2-9404018X-WM	
		50°	2200lm	1500lm	SMS2-9405018X-WM	
 Black Reflector		18 W 21 W 36 V 500 mA 90 2700K	28°	1800lm	1300lm	SMS2-9272818X-WB
			40°	1800lm	1300lm	SMS2-9274018X-WB
			50°	1800lm	1300lm	SMS2-9275018X-WB
	3000K	28°	2000lm	1400lm	SMS2-9302818X-WB	
		40°	2000lm	1400lm	SMS2-9304018X-WB	
		50°	2000lm	1400lm	SMS2-9305018X-WB	
	4000K	28°	2200lm	1500lm	SMS2-9402818X-WB	
		40°	2200lm	1500lm	SMS2-9404018X-WB	
		50°	2200lm	1500lm	SMS2-9405018X-WB	

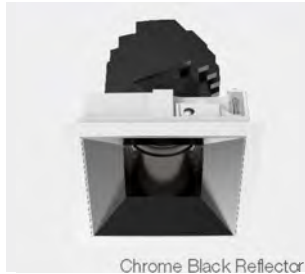
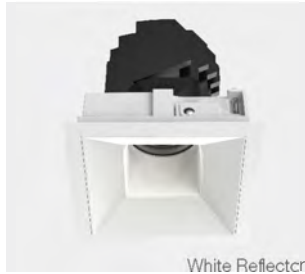
Code Remark: X=F(ON-OFF) X=P(Phase Dim) X=A(1-10V Dim) X=D(DALI Dim)

LED Power System Power LED Voltage LED Current CRI CCT Beam LED Output System Output Code						
 Chrome Black Reflector	18 W 21 W 36 V 500 mA 90 2700K	28°	1800lm	1300lm	SMS2-9272818X-WC	
		40°	1800lm	1300lm	SMS2-9274018X-WC	
		50°	1800lm	1300lm	SMS2-9275018X-WC	
	3000K	28°	2000lm	1400lm	SMS2-9302818X-WC	
		40°	2000lm	1400lm	SMS2-9304018X-WC	
		50°	2000lm	1400lm	SMS2-9305018X-WC	
	4000K	28°	2200lm	1500lm	SMS2-9402818X-WC	
		40°	2200lm	1500lm	SMS2-9404018X-WC	
		50°	2200lm	1500lm	SMS2-9405018X-WC	
	 White Reflector	18 W 21 W 36 V 500 mA 90 2700K	28°	1800lm	1300lm	SMS2-9272818X-WW
			40°	1800lm	1300lm	SMS2-9274018X-WW
			50°	1800lm	1300lm	SMS2-9275018X-WW
3000K		28°	2000lm	1400lm	SMS2-9302818X-WW	
		40°	2000lm	1400lm	SMS2-9304018X-WW	
		50°	2000lm	1400lm	SMS2-9305018X-WW	
4000K		28°	2200lm	1500lm	SMS2-9402818X-WW	
		40°	2200lm	1500lm	SMS2-9404018X-WW	
		50°	2200lm	1500lm	SMS2-9405018X-WW	
 Gold Reflector		18 W 21 W 36 V 500 mA 90 2700K	28°	1800lm	1300lm	SMS2-9272818X-WG
			40°	1800lm	1300lm	SMS2-9274018X-WG
			50°	1800lm	1300lm	SMS2-9275018X-WG
	3000K	28°	2000lm	1400lm	SMS2-9302818X-WG	
		40°	2000lm	1400lm	SMS2-9304018X-WG	
		50°	2000lm	1400lm	SMS2-9305018X-WG	
	4000K	28°	2200lm	1500lm	SMS2-9402818X-WG	
		40°	2200lm	1500lm	SMS2-9404018X-WG	
		50°	2200lm	1500lm	SMS2-9405018X-WG	

Code Remark: X=F(ON-OFF) X=P(Phase Dim) X=A(1-10V Dim) X=D(DALI Dim)

Trimless Version available



Trimless code for SMS2-9304018X-WM → SMS5-9304018X-WM

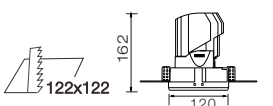



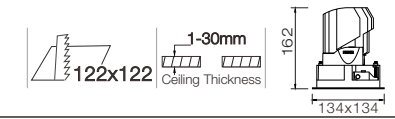
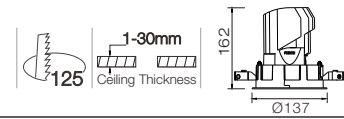
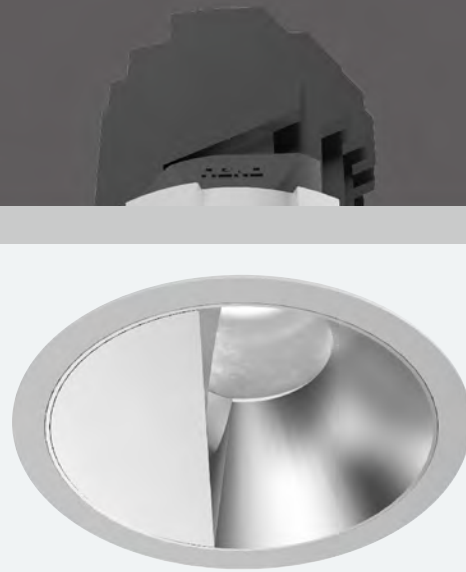

LED Power	System power	LED Voltage	LED Current	CRI	CCT	Beam	LED Output	System Output	Code	
18 W	21 W	36 V	500 mA	80	2700K	Wall Washer	1800lm	800lm	SMR3-827WW18X-WM	
					3000K	Wall Washer	2000lm	850lm	SMR3-830WW18X-WM	
					4000K	Wall Washer	2200lm	900lm	SMR3-840WW18X-WM	
					90	2700K	Wall Washer	1600lm	700lm	SMR3-927WW18X-WM
					3000K	Wall Washer	1800lm	750lm	SMR3-930WW18X-WM	
					4000K	Wall Washer	2000lm	800lm	SMR3-940WW18X-WM	

Code Remark: X=F(ON-OFF) X=P(Phase Dim) X=A(1-10V Dim) X=D(DALI Dim)



Trimless Version available



Trimless code for SMR3-930WW18X-WM → SMR6-930WW18X-WM

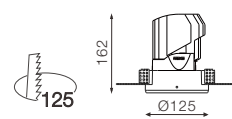

LED Power	System power	LED Voltage	LED Current	CRI	CCT	Beam	LED Output	System Output	Code	
18 W	21 W	36 V	500 mA	80	2700K	Wall Washer	1800lm	800lm	SMS3-827WW18X-WM	
					3000K	Wall Washer	2000lm	850lm	SMS3-830WW18X-WM	
					4000K	Wall Washer	2200lm	900lm	SMS3-840WW18X-WM	
					90	2700K	Wall Washer	1600lm	600lm	SMS3-927WW18X-WM
					3000K	Wall Washer	1800lm	680lm	SMS3-930WW18X-WM	
					4000K	Wall Washer	2000lm	750lm	SMS3-940WW18X-WM	

Code Remark: X=F(ON-OFF) X=P(Phase Dim) X=A(1-10V Dim) X=D(DALI Dim)

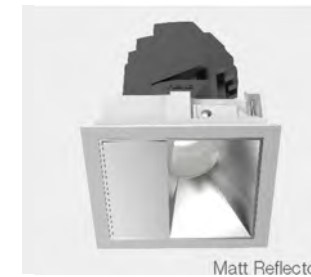

Trimless Version available



Trimless code for SMS3-930WW18X-WM → SMS6-930WW18X-WM

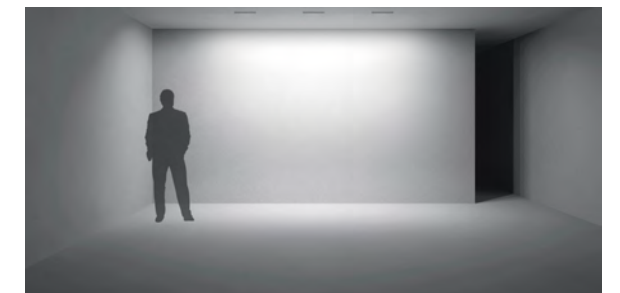
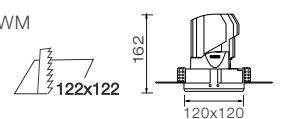

**NEKO / SENSE 150 / S150R1**  
Adjustable LED Downlight

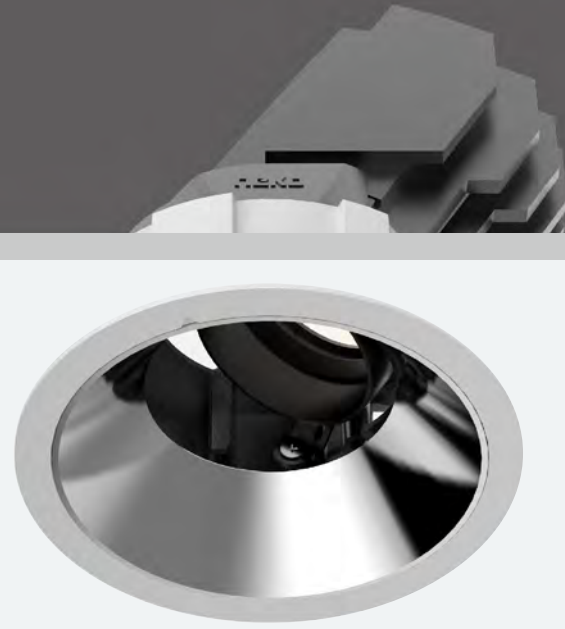

25W CRI90 2700K 3000K 4000K 20° 35° 50° CITIZEN 50,000h@L80B10 UGR < 19 IP20 5 YEAR WARRANTY CB CE CUL US LISTED

Reflector	LED Power	System Power	LED Voltage	LED Current	CRI	CCT	Beam	LED Output	System Output	Code	
Specular Reflector	25 W	28 W	36 V	700 mA	90	2700K	20°	2500lm	1700lm	SLR1-9272025X-WC	
							35°	2500lm	1700lm	SLR1-9273525X-WC	
							50°	2500lm	1700lm	SLR1-9275025X-WC	
	3000K	20°	2700lm	1800lm	1800lm	1800lm	SLR1-9302025X-WC				
							35°	2700lm	1800lm	SLR1-9303525X-WC	
							50°	2700lm	1800lm	SLR1-9305025X-WC	
		4000K	20°	2900lm	1900lm	1900lm	1900lm	SLR1-9402025X-WC			
								35°	2900lm	1900lm	SLR1-9403525X-WC
								50°	2900lm	1900lm	SLR1-9405025X-WC
	Matt Reflector	25 W	28 W	36 V	700 mA	90	2700K	20°	2500lm	1700lm	SLR1-9272025X-WM
								35°	2500lm	1700lm	SLR1-9273525X-WM
								50°	2500lm	1700lm	SLR1-9275025X-WM
3000K		20°	2700lm	1800lm	1800lm	1800lm	SLR1-9302025X-WM				
							35°	2700lm	1800lm	SLR1-9303525X-WM	
							50°	2700lm	1800lm	SLR1-9305025X-WM	
		4000K	20°	2900lm	1900lm	1900lm	1900lm	SLR1-9402025X-WM			
								35°	2900lm	1900lm	SLR1-9403525X-WM
								50°	2900lm	1900lm	SLR1-9405025X-WM
Black Reflector		25 W	28 W	36 V	700 mA	90	2700K	20°	2500lm	1700lm	SLR1-9272025X-WB
								35°	2500lm	1700lm	SLR1-9273525X-WB
								50°	2500lm	1700lm	SLR1-9275025X-WB
	3000K	20°	2700lm	1800lm	1800lm	1800lm	SLR1-9302025X-WB				
							35°	2700lm	1800lm	SLR1-9303525X-WB	
							50°	2700lm	1800lm	SLR1-9305025X-WB	
		4000K	20°	2900lm	1900lm	1900lm	1900lm	SLR1-9402025X-WB			
								35°	2900lm	1900lm	SLR1-9403525X-WB
								50°	2900lm	1900lm	SLR1-9405025X-WB

Code Remark: X=F(ON-OFF) X=P(Phase Dim) X=A(1-10V Dim) X=D(DALI Dim)

Optional accessory

Code for SLR1-9302025X-WM with Honeycomb  
SLR1-9302025X-WM-H

Honeycomb HCSR150

LED Power	System Power	LED Voltage	LED Current	CRI	CCT	Beam	LED Output	System Output	Code		
25 W	28 W	36 V	700 mA	90	2700K	20°	2500lm	1700lm	SLR1-9272025X-WC		
						35°	2500lm	1700lm	SLR1-9273525X-WC		
						50°	2500lm	1700lm	SLR1-9275025X-WC		
	3000K	20°	2700lm	1800lm	1800lm	1800lm	SLR1-9302025X-WC				
							35°	2700lm	1800lm	SLR1-9303525X-WC	
							50°	2700lm	1800lm	SLR1-9305025X-WC	
		4000K	20°	2900lm	1900lm	1900lm	1900lm	SLR1-9402025X-WC			
								35°	2900lm	1900lm	SLR1-9403525X-WC
								50°	2900lm	1900lm	SLR1-9405025X-WC
	25 W	28 W	36 V	700 mA	90	2700K	20°	2500lm	1700lm	SLR1-9272025X-WW	
							35°	2500lm	1700lm	SLR1-9273525X-WW	
							50°	2500lm	1700lm	SLR1-9275025X-WW	
3000K		20°	2700lm	1800lm	1800lm	1800lm	SLR1-9302025X-WW				
							35°	2700lm	1800lm	SLR1-9303525X-WW	
							50°	2700lm	1800lm	SLR1-9305025X-WW	
		4000K	20°	2900lm	1900lm	1900lm	1900lm	SLR1-9402025X-WW			
								35°	2900lm	1900lm	SLR1-9403525X-WW
								50°	2900lm	1900lm	SLR1-9405025X-WW
25 W		28 W	36 V	700 mA	90	2700K	20°	2500lm	1700lm	SLR1-9272025X-WG	
							35°	2500lm	1700lm	SLR1-9273525X-WG	
							50°	2500lm	1700lm	SLR1-9275025X-WG	
	3000K	20°	2700lm	1800lm	1800lm	1800lm	SLR1-9302025X-WG				
							35°	2700lm	1800lm	SLR1-9303525X-WG	
							50°	2700lm	1800lm	SLR1-9305025X-WG	
		4000K	20°	2900lm	1900lm	1900lm	1900lm	SLR1-9402025X-WG			
								35°	2900lm	1900lm	SLR1-9403525X-WG
								50°	2900lm	1900lm	SLR1-9405025X-WG

Code Remark: X=F(ON-OFF) X=P(Phase Dim) X=A(1-10V Dim) X=D(DALI Dim)

Trimless Version available

Trimless code for SLR1-9303525X-WM → SLR4-9303525X-WM

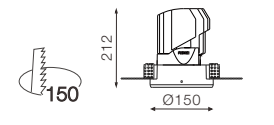



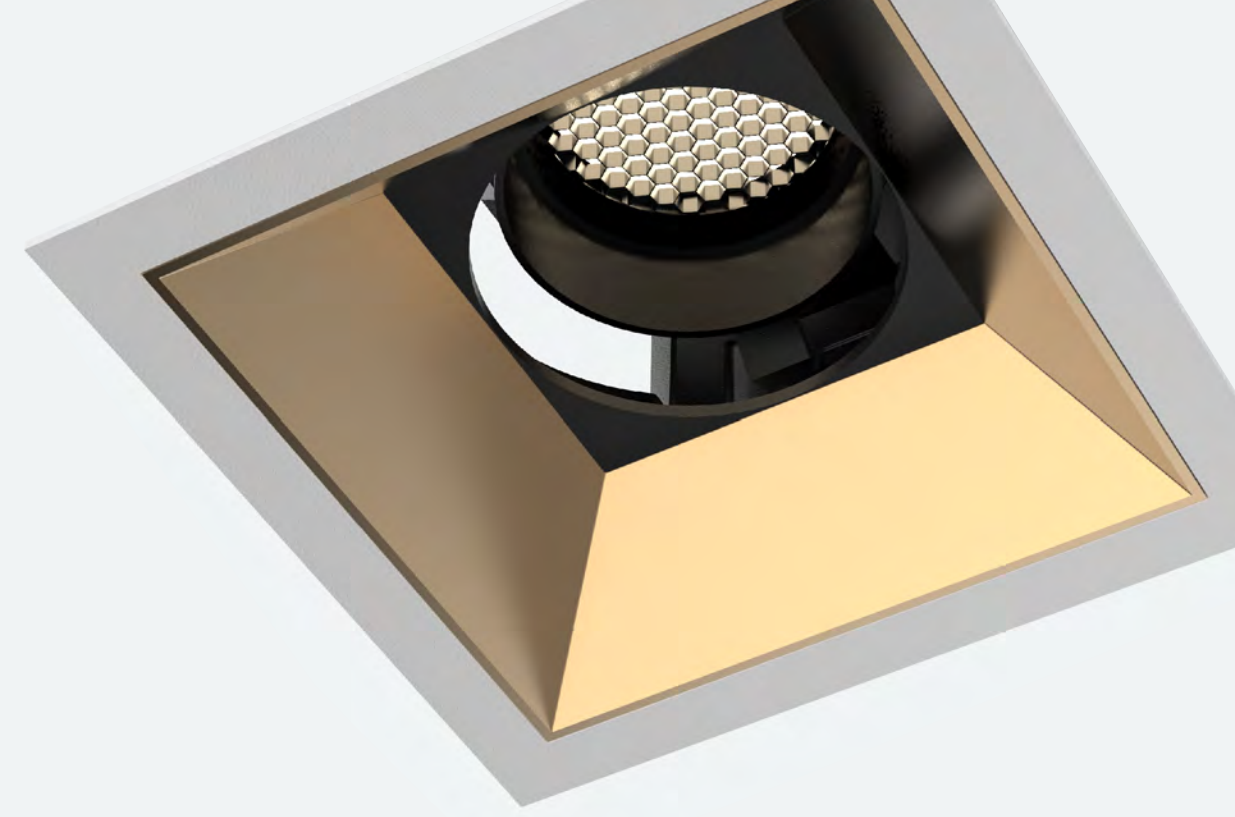
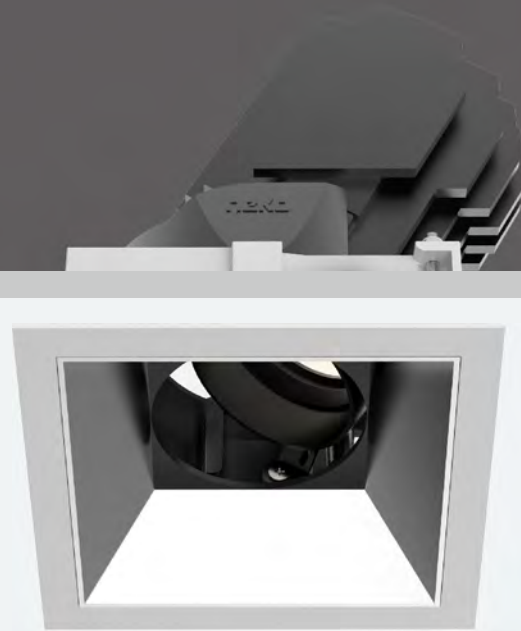

**NEKO / SENSE 150 / S150S1**  
Adjustable LED Downlight

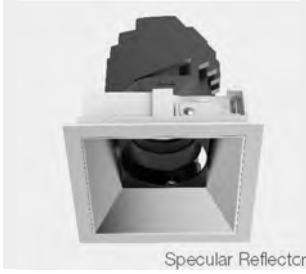

25W CRI90 2700K 3000K 4000K 20° 35° 50° CITIZEN 50,000h@L80B10 UGR < 19 IP20 5 YEAR WARRANTY CB CE cUL US LISTED

LED Power System Power LED Voltage LED Current CRI CCT Beam LED Output System Output Code						
 Specular Reflector	25 W 28 W 36 V 700 mA 90 2700K	20°	2500lm	1700lm	SLS1-9272025X-WS	
		35°	2500lm	1700lm	SLS1-9273525X-WS	
		50°	2500lm	1700lm	SLS1-9275025X-WS	
	3000K	20°	2700lm	1800lm	SLS1-9302025X-WS	
		35°	2700lm	1800lm	SLS1-9303525X-WS	
		50°	2700lm	1800lm	SLS1-9305025X-WS	
	4000K	20°	2900lm	1900lm	SLS1-9402025X-WS	
		35°	2900lm	1900lm	SLS1-9403525X-WS	
		50°	2900lm	1900lm	SLS1-9405025X-WS	
	 White Reflector	25 W 28 W 36 V 700 mA 90 2700K	20°	2500lm	1700lm	SLS1-9272025X-WM
			35°	2500lm	1700lm	SLS1-9273525X-WM
			50°	2500lm	1700lm	SLS1-9275025X-WM
3000K		20°	2700lm	1800lm	SLS1-9302025X-WM	
		35°	2700lm	1800lm	SLS1-9303525X-WM	
		50°	2700lm	1800lm	SLS1-9305025X-WM	
4000K		20°	2900lm	1900lm	SLS1-9402025X-WM	
		35°	2900lm	1900lm	SLS1-9403525X-WM	
		50°	2900lm	1900lm	SLS1-9405025X-WM	
 Matt Reflector		25 W 28 W 36 V 700 mA 90 2700K	20°	2500lm	1700lm	SLS1-9272025X-WB
			35°	2500lm	1700lm	SLS1-9273525X-WB
			50°	2500lm	1700lm	SLS1-9275025X-WB
	3000K	20°	2700lm	1800lm	SLS1-9302025X-WB	
		35°	2700lm	1800lm	SLS1-9303525X-WB	
		50°	2700lm	1800lm	SLS1-9305025X-WB	
	4000K	20°	2900lm	1900lm	SLS1-9402025X-WB	
		35°	2900lm	1900lm	SLS1-9403525X-WB	
		50°	2900lm	1900lm	SLS1-9405025X-WB	

Code Remark: X=F(ON-OFF) X=P(Phase Dim) X=A(1-10V Dim) X=D(DALI Dim)



Optional accessory

Code for SLS1-9304025X-WM with Honeycomb  
SLS1-9304025X-WM-H

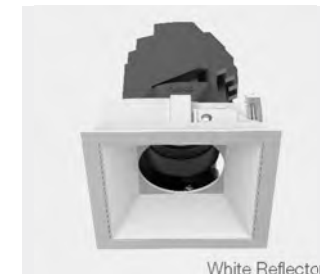
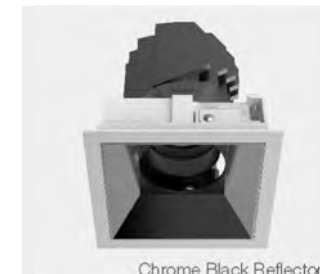

Honeycomb  
HCSR150

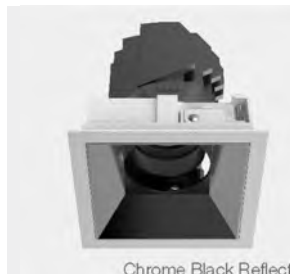
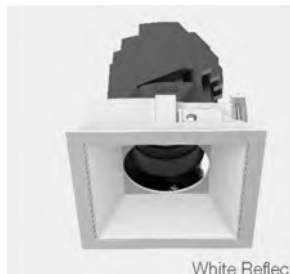

LED Power System Power LED Voltage LED Current CRI CCT Beam LED Output System Output Code						
 Chrome Black Reflector	25 W 28 W 36 V 700 mA 90 2700K	20°	2500lm	1700lm	SLS1-9272025X-WC	
		35°	2500lm	1700lm	SLS1-9273525X-WC	
		50°	2500lm	1700lm	SLS1-9275025X-WC	
	3000K	20°	2700lm	1800lm	SLS1-9302025X-WC	
		35°	2700lm	1800lm	SLS1-9303525X-WC	
		50°	2700lm	1800lm	SLS1-9305025X-WC	
	4000K	20°	2900lm	1900lm	SLS1-9402025X-WC	
		35°	2900lm	1900lm	SLS1-9403525X-WC	
		50°	2900lm	1900lm	SLS1-9405025X-WC	
	 White Reflector	25 W 28 W 36 V 700 mA 90 2700K	20°	2500lm	1700lm	SLS1-9272025X-WW
			35°	2500lm	1700lm	SLS1-9273525X-WW
			50°	2500lm	1700lm	SLS1-9275025X-WW
3000K		20°	2700lm	1800lm	SLS1-9302025X-WW	
		35°	2700lm	1800lm	SLS1-9303525X-WW	
		50°	2700lm	1800lm	SLS1-9305025X-WW	
4000K		20°	2900lm	1900lm	SLS1-9402025X-WW	
		35°	2900lm	1900lm	SLS1-9403525X-WW	
		50°	2900lm	1900lm	SLS1-9405025X-WW	
 Gold Reflector		25 W 28 W 36 V 700 mA 90 2700K	20°	2500lm	1700lm	SLS1-9272025X-WG
			35°	2500lm	1700lm	SLS1-9273525X-WG
			50°	2500lm	1700lm	SLS1-9275025X-WG
	3000K	20°	2700lm	1800lm	SLS1-9302025X-WG	
		35°	2700lm	1800lm	SLS1-9303525X-WG	
		50°	2700lm	1800lm	SLS1-9305025X-WG	
	4000K	20°	2900lm	1900lm	SLS1-9402025X-WG	
		35°	2900lm	1900lm	SLS1-9403525X-WG	
		50°	2900lm	1900lm	SLS1-9405025X-WG	

Code Remark: X=F(ON-OFF) X=P(Phase Dim) X=A(1-10V Dim) X=D(DALI Dim)

Trimless Version available

Trimless code for SLS1-9303525X-WM → SLS4-9303525X-WM

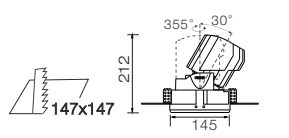

NEKO / SENSE 150 / S150R2  
Fixed LED Downlight



25W CRI90 2700K 28° 32° 50° 3000K 4000K CITIZEN 50,000h@L80B10 UGR < 19 IP 20 5 YEAR WARRANTY CB CE C-UL US LISTED

LED Power	System Power	LED Voltage	LED Current	CRI	CCT	Beam	LED Output	System Output	Code	
25 W	28 W	36 V	700 mA	90	2700K	28°	2500lm	1800lm	SLR2-9272825X-WB	
						32°	2500lm	1800lm	SLR2-9273225X-WB	
						50°	2500lm	1800lm	SLR2-9275025X-WB	
						3000K	28°	2700lm	1900lm	SLR2-9302825X-WB
							32°	2700lm	1900lm	SLR2-9303225X-WB
							50°	2700lm	1900lm	SLR2-9305025X-WB
						4000K	28°	2900lm	2000lm	SLR2-9402825X-WB
							32°	2900lm	2000lm	SLR2-9403225X-WB
							50°	2900lm	2000lm	SLR2-9405025X-WB



Code Remark: X=F(ON-OFF) X=P(Phase Dim) X=A(1-10V Dim) X=D(DALI Dim)



LED Power	System Power	LED Voltage	LED Current	CRI	CCT	Beam	LED Output	System Output	Code	
25 W	28 W	36 V	700 mA	90	2700K	28°	2500lm	1800lm	SLR2-9272825X-WC	
						32°	2500lm	1800lm	SLR2-9273225X-WC	
						50°	2500lm	1800lm	SLR2-9275025X-WC	
						3000K	28°	2700lm	1900lm	SLR2-9302825X-WC
							32°	2700lm	1900lm	SLR2-9303225X-WC
							50°	2700lm	1900lm	SLR2-9305025X-WC
						4000K	28°	2900lm	2000lm	SLR2-9402825X-WC
							32°	2900lm	2000lm	SLR2-9403225X-WC
							50°	2900lm	2000lm	SLR2-9405025X-WC

Code Remark: X=F(ON-OFF) X=P(Phase Dim) X=A(1-10V Dim) X=D(DALI Dim)

Trimless Version available

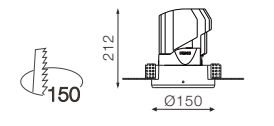
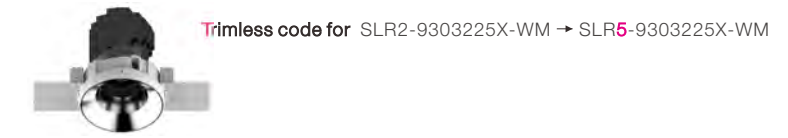





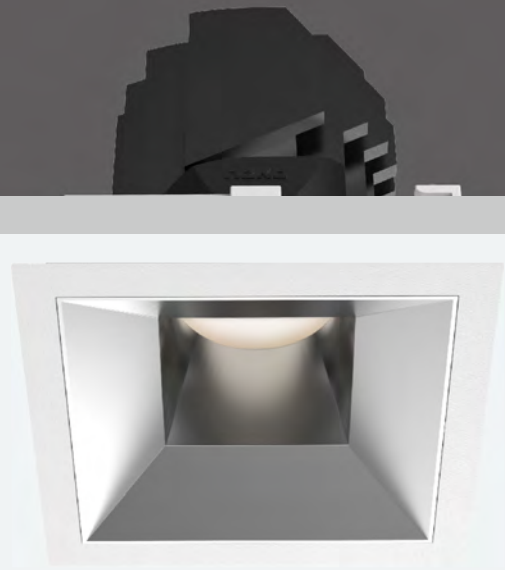

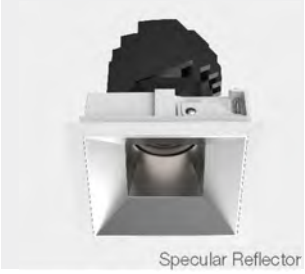

**NEKO / SENSE 150 / S150S2**  
Fixed LED Downlight



25W CRI90 2700K 28° 3000K 32° 4000K 50° CITIZEN 50,000h@L80B10 UGR < 19 IP20 5 YEAR GUARANTEED CB CE CUL US LISTED 147x147 1-35mm Ceiling Thickness 212 159x159

LED Power System Power LED Voltage LED Current CRI CCT Beam LED Output System Output Code						
 <p>Specular Reflector</p>	25 W 28 W 36 V 700 mA 90 2700K	28°	2500lm	1800lm	SLS2-9272825X-WS	
		32°	2500lm	1800lm	SLS2-9273225X-WS	
		50°	2500lm	1800lm	SLS2-9275025X-WS	
	3000K	28°	2700lm	1900lm	SLS2-9302825X-WS	
		32°	2700lm	1900lm	SLS2-9303225X-WS	
		50°	2700lm	1900lm	SLS2-9305025X-WS	
	4000K	28°	2900lm	2000lm	SLS2-9402825X-WS	
		32°	2900lm	2000lm	SLS2-9403225X-WS	
		50°	2900lm	2000lm	SLS2-9405025X-WS	
	 <p>White Reflector</p>	25 W 28 W 36 V 700 mA 90 2700K	28°	2500lm	1800lm	SLS2-9272825X-WM
			32°	2500lm	1800lm	SLS2-9273225X-WM
			50°	2500lm	1800lm	SLS2-9275025X-WM
3000K		28°	2700lm	1900lm	SLS2-9302825X-WM	
		32°	2700lm	1900lm	SLS2-9303225X-WM	
		50°	2700lm	1900lm	SLS2-9305025X-WM	
4000K		28°	2900lm	2000lm	SLS2-9402825X-WM	
		32°	2900lm	2000lm	SLS2-9403225X-WM	
		50°	2900lm	2000lm	SLS2-9405025X-WM	
 <p>Matt Reflector</p>		25 W 28 W 36 V 700 mA 90 2700K	28°	2500lm	1800lm	SLS2-9272825X-WB
			32°	2500lm	1800lm	SLS2-9273225X-WB
			50°	2500lm	1800lm	SLS2-9275025X-WB
	3000K	28°	2700lm	1900lm	SLS2-9302825X-WB	
		32°	2700lm	1900lm	SLS2-9303225X-WB	
		50°	2700lm	1900lm	SLS2-9305025X-WB	
	4000K	28°	2900lm	2000lm	SLS2-9402825X-WB	
		32°	2900lm	2000lm	SLS2-9403225X-WB	
		50°	2900lm	2000lm	SLS2-9405025X-WB	
	 <p>Black Reflector</p>	25 W 28 W 36 V 700 mA 90 2700K	28°	2500lm	1800lm	SLS2-9272825X-WB
			32°	2500lm	1800lm	SLS2-9273225X-WB
			50°	2500lm	1800lm	SLS2-9275025X-WB
3000K		28°	2700lm	1900lm	SLS2-9302825X-WB	
		32°	2700lm	1900lm	SLS2-9303225X-WB	
		50°	2700lm	1900lm	SLS2-9305025X-WB	
4000K		28°	2900lm	2000lm	SLS2-9402825X-WB	
		32°	2900lm	2000lm	SLS2-9403225X-WB	
		50°	2900lm	2000lm	SLS2-9405025X-WB	

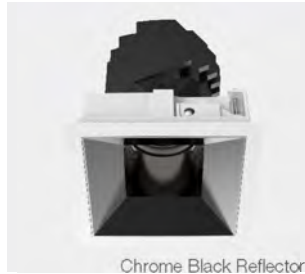
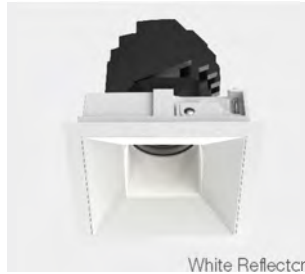
Code Remark: X=F(ON-OFF) X=P(Phase Dim) X=A(1-10V Dim) X=D(DALI Dim)

LED Power System Power LED Voltage LED Current CRI CCT Beam LED Output System Output Code						
 <p>Chrome Black Reflector</p>	25 W 28 W 36 V 700 mA 90 2700K	28°	2500lm	1800lm	SLS2-9272825X-WC	
		32°	2500lm	1800lm	SLS2-9273225X-WC	
		50°	2500lm	1800lm	SLS2-9275025X-WC	
	3000K	28°	2700lm	1900lm	SLS2-9302825X-WC	
		32°	2700lm	1900lm	SLS2-9303225X-WC	
		50°	2700lm	1900lm	SLS2-9305025X-WC	
	4000K	28°	2900lm	2000lm	SLS2-9402825X-WC	
		32°	2900lm	2000lm	SLS2-9403225X-WC	
		50°	2900lm	2000lm	SLS2-9405025X-WC	
	 <p>White Reflector</p>	25 W 28 W 36 V 700 mA 90 2700K	28°	2500lm	1800lm	SLS2-9272825X-WW
			32°	2500lm	1800lm	SLS2-9273225X-WW
			50°	2500lm	1800lm	SLS2-9275025X-WW
3000K		28°	2700lm	1900lm	SLS2-9302825X-WW	
		32°	2700lm	1900lm	SLS2-9303225X-WW	
		50°	2700lm	1900lm	SLS2-9305025X-WW	
4000K		28°	2900lm	2000lm	SLS2-9402825X-WW	
		32°	2900lm	2000lm	SLS2-9403225X-WW	
		50°	2900lm	2000lm	SLS2-9405025X-WW	
 <p>Gold Reflector</p>		25 W 28 W 36 V 700 mA 90 2700K	28°	2500lm	1800lm	SLS2-9272825X-WG
			32°	2500lm	1800lm	SLS2-9273225X-WG
			50°	2500lm	1800lm	SLS2-9275025X-WG
	3000K	28°	2700lm	1900lm	SLS2-9302825X-WG	
		32°	2700lm	1900lm	SLS2-9303225X-WG	
		50°	2700lm	1900lm	SLS2-9305025X-WG	
	4000K	28°	2900lm	2000lm	SLS2-9402825X-WG	
		32°	2900lm	2000lm	SLS2-9403225X-WG	
		50°	2900lm	2000lm	SLS2-9405025X-WG	

Code Remark: X=F(ON-OFF) X=P(Phase Dim) X=A(1-10V Dim) X=D(DALI Dim)

Trimless Version available

Trimless code for SLS2-9303225X-WM → SLS5-9303225X-WM

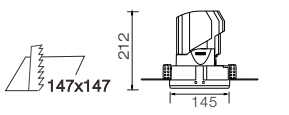

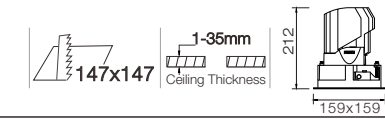
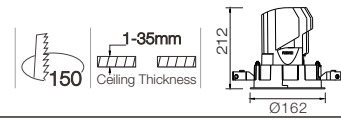
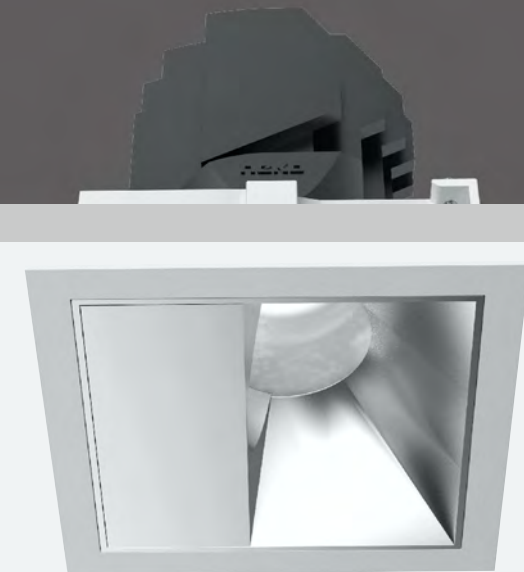
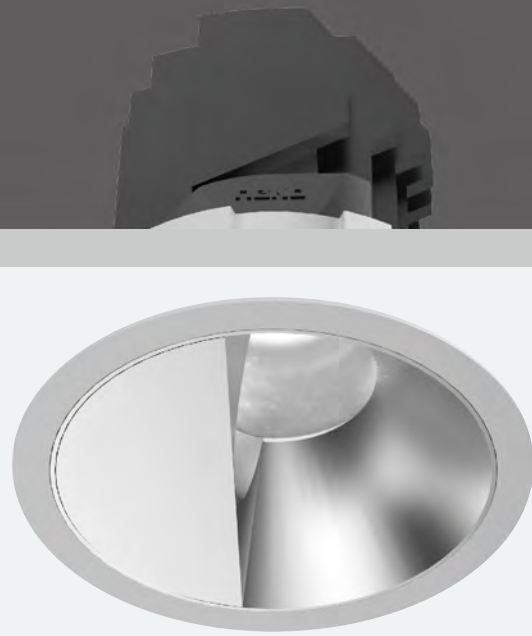
LED Power	System power	LED Voltage	LED Current	CRI	CCT	Beam	LED Output	System Output	Code	
25 W	28 W	36 V	700 mA	80	2700K	Wall Washer	2700lm	1000lm	SLR3-827WW25X-WM	
					3000K	Wall Washer	2900lm	1100lm	SLR3-830WW25X-WM	
					4000K	Wall Washer	3100lm	1200lm	SLR3-840WW25X-WM	
					90	2700K	Wall Washer	2500lm	900lm	SLR3-927WW25X-WM
					3000K	Wall Washer	2700lm	1000lm	SLR3-930WW25X-WM	
					4000K	Wall Washer	2900lm	1100lm	SLR3-940WW25X-WM	

Code Remark: X=F(ON-OFF) X=P(Phase Dim) X=A(1-10V Dim) X=D(DALI Dim)



Trimless Version available



Trimless code for SLR3-930WW25X-WM → SLR6-930WW25X-WM

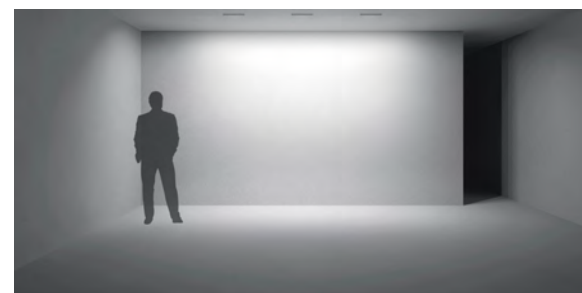
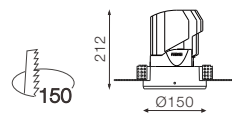

LED Power	System power	LED Voltage	LED Current	CRI	CCT	Beam	LED Output	System Output	Code	
25 W	28 W	36 V	700 mA	80	2700K	Wall Washer	2700lm	1000lm	SLS3-827WW25X-WM	
					3000K	Wall Washer	2900lm	1100lm	SLS3-830WW25X-WM	
					4000K	Wall Washer	3100lm	1200lm	SLS3-840WW25X-WM	
					90	2700K	Wall Washer	2500lm	900lm	SLS3-927WW25X-WM
					3000K	Wall Washer	2700lm	1000lm	SLS3-930WW25X-WM	
					4000K	Wall Washer	2900lm	1100lm	SLS3-940WW25X-WM	

Code Remark: X=F(ON-OFF) X=P(Phase Dim) X=A(1-10V Dim) X=D(DALI Dim)

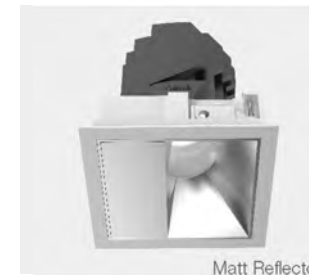

Trimless Version available



Trimless code for SLS3-930WW25X-WM → SLS6-930WW25X-WM

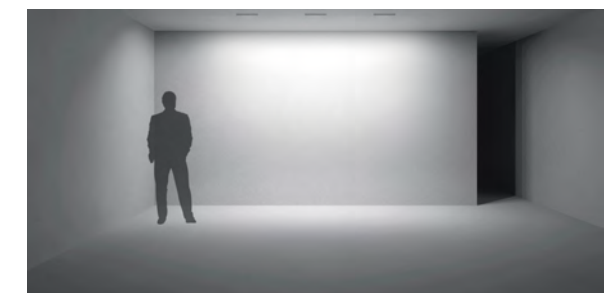
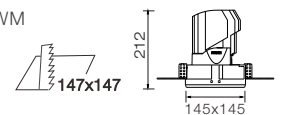



**NEKO / TAKEO**  
Fixed LED Downlight  
Super Eye Comfort  
High Efficiency



TAKEO T100



TAKEO T150



TAKEO T200



4"



6"



8"

- Interchangeable Design
- Super Eye Comfort
- UGR<15
- IP54
- High Efficiency

**NEKO / TAKEO**  
**Fixed LED Downlight**  
 Super Eye Comfort  
 High Efficiency

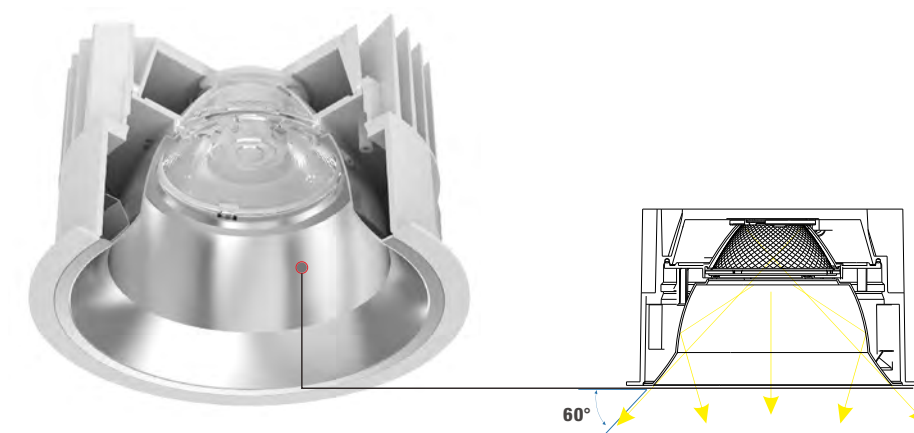
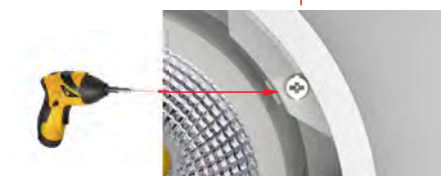
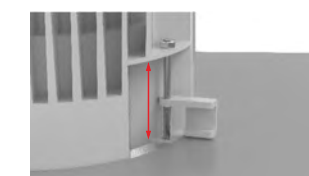
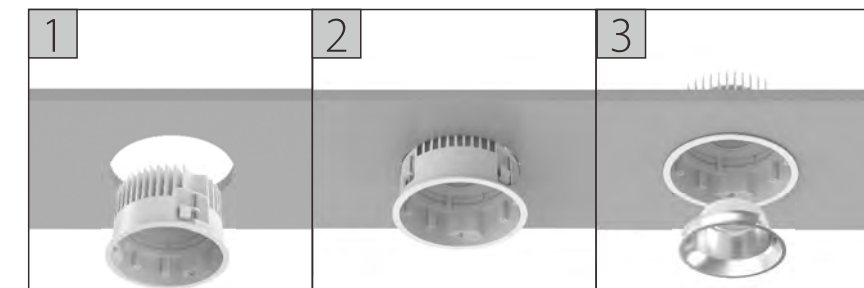
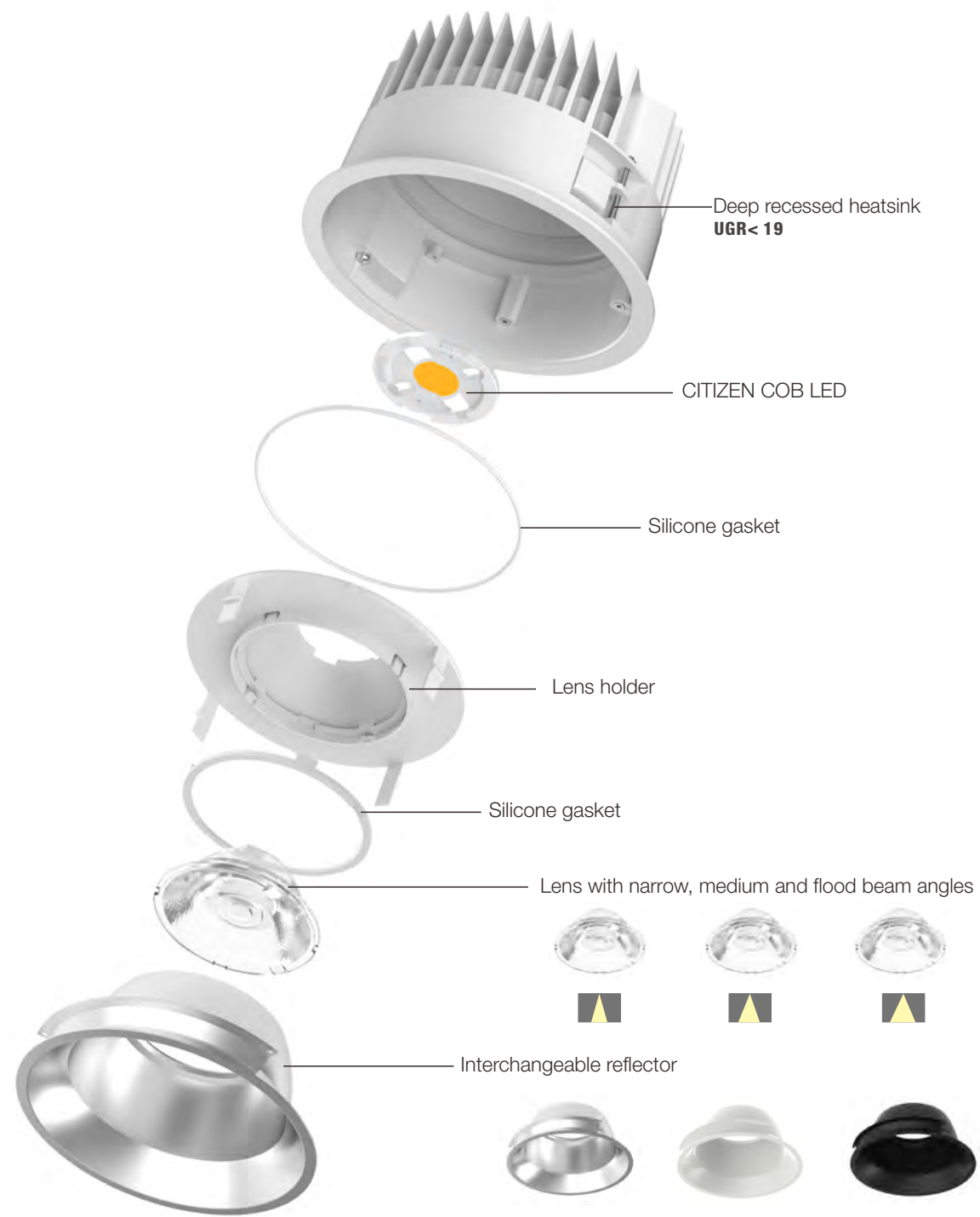



**NEKO / TAKEO / T100**

**Fixed LED Downlight**

Super Eye Comfort  
High Efficiency

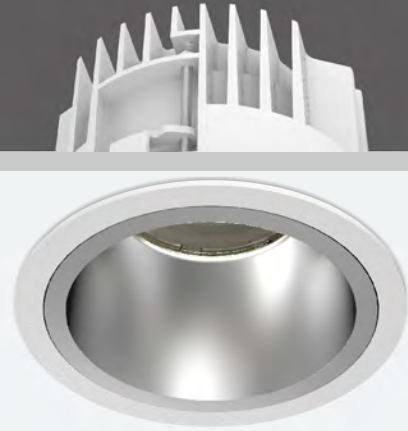

13W CRI80 2700K 30° 30°  
9W CRI90 3000K 50°  
4000K 50,000h@L80B10  
CITIZEN  
UGR < 19  
IP 54  
5 YEAR WARRANTY  
CB CE

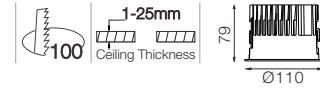

LED Power	System Power	LED Voltage	LED Current	CRI	CCT	Beam	LED Output	System Output	Code								
9 W	11 W	36 V	250 mA	80	3000K	30°	1300lm	1100lm	TS1-8303009X-WM								
						50°	1300lm	1000lm	TS1-8305009X-WM								
						4000K	30°	1400lm	1200lm	TS1-8403009X-WM							
							50°	1400lm	1100lm	TS1-8405009X-WM							
						90	3000K	30°	1100lm	950lm	TS1-9303009X-WM						
								50°	1100lm	850lm	TS1-9305009X-WM						
								4000K	30°	1200lm	1050lm	TS1-9403009X-WM					
									50°	1200lm	950lm	TS1-9405009X-WM					
								13 W	15 W	36 V	350 mA	80	3000K	30°	1800lm	1500lm	TS2-8303013X-WM
														50°	1800lm	1300lm	TS2-8305013X-WM
						4000K	30°							1900lm	1600lm	TS2-8403013X-WM	
							50°							1900lm	1400lm	TS2-8405013X-WM	
90	3000K	30°	1500lm	1300lm	TS2-9303013X-WM												
		50°	1500lm	1100lm	TS2-9305013X-WM												
		4000K	30°	1600lm	1400lm	TS2-9403013X-WM											
			50°	1600lm	1200lm	TS2-9405013X-WM											



LED Power	System Power	LED Voltage	LED Current	CRI	CCT	Beam	LED Output	System Output	Code								
9 W	11 W	36 V	250 mA	80	3000K	30°	1300lm	1100lm	TS1-8303009X-WW								
						50°	1300lm	1000lm	TS1-8305009X-WW								
						4000K	30°	1400lm	1200lm	TS1-8403009X-WW							
							50°	1400lm	1100lm	TS1-8405009X-WW							
						90	3000K	30°	1100lm	950lm	TS1-9303009X-WW						
								50°	1100lm	850lm	TS1-9305009X-WW						
								4000K	30°	1200lm	1050lm	TS1-9403009X-WW					
									50°	1200lm	950lm	TS1-9405009X-WW					
								13 W	15 W	36 V	350 mA	80	3000K	30°	1800lm	1500lm	TS2-8303013X-WW
														50°	1800lm	1300lm	TS2-8305013X-WW
						4000K	30°							1900lm	1600lm	TS2-8403013X-WW	
							50°							1900lm	1400lm	TS2-8405013X-WW	
90	3000K	30°	1500lm	1300lm	TS2-9303013X-WW												
		50°	1500lm	1100lm	TS2-9305013X-WW												
		4000K	30°	1600lm	1400lm	TS2-9403013X-WW											
			50°	1600lm	1200lm	TS2-9405013X-WW											



Code Remark: X=F(ON-OFF) X=P(Phase Dim) X=A(1-10V Dim) X=D(DALI Dim)



LED Power	System Power	LED Voltage	LED Current	CRI	CCT	Beam	LED Output	System Output	Code								
9 W	11 W	36 V	250 mA	80	3000K	30°	1300lm	1100lm	TS1-8303009X-WB								
						50°	1300lm	1000lm	TS1-8305009X-WB								
						4000K	30°	1400lm	1200lm	TS1-8403009X-WB							
							50°	1400lm	1100lm	TS1-8405009X-WB							
						90	3000K	30°	1100lm	950lm	TS1-9303009X-WB						
								50°	1100lm	850lm	TS1-9305009X-WB						
								4000K	30°	1200lm	1050lm	TS1-9403009X-WB					
									50°	1200lm	950lm	TS1-9405009X-WB					
								13 W	15 W	36 V	350 mA	80	3000K	30°	1800lm	1500lm	TS2-8303013X-WB
														50°	1800lm	1300lm	TS2-8305013X-WB
						4000K	30°							1900lm	1600lm	TS2-8403013X-WB	
							50°							1900lm	1400lm	TS2-8405013X-WB	
90	3000K	30°	1500lm	1300lm	TS2-9303013X-WB												
		50°	1500lm	1100lm	TS2-9305013X-WB												
		4000K	30°	1600lm	1400lm	TS2-9403013X-WB											
			50°	1600lm	1200lm	TS2-9405013X-WB											

Code Remark: X=F(ON-OFF) X=P(Phase Dim) X=A(1-10V Dim) X=D(DALI Dim)

**NEKO / TAKEO / T150**

**Fixed LED Downlight**

Super Eye Comfort  
High Efficiency

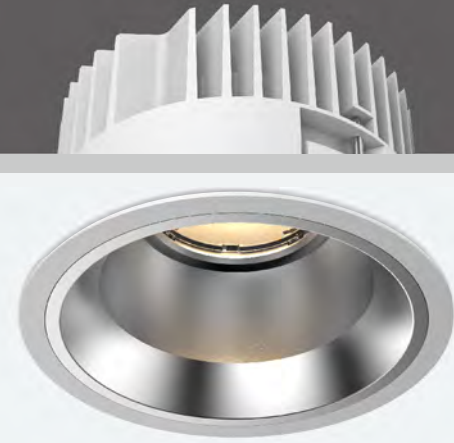

LED Power	System Power	LED Voltage	LED Current	CRI	CCT	Beam	LED Output	System Output	Code								
18 W	21 W	36 V	500 mA	80	3000K	30°	2800lm	2300lm	TM1-8303018X-WM								
						60°	2800lm	2000lm	TM1-8306018X-WM								
						4000K	30°	3000lm	2500lm	TM1-8403018X-WM							
							60°	3000lm	2200lm	TM1-8406018X-WM							
						90	3000K	30°	2400lm	2000lm	TM1-9303018X-WM						
								60°	2400lm	1800lm	TM1-9306018X-WM						
								4000K	30°	2600lm	2200lm	TM1-9403018X-WM					
									60°	2600lm	1900lm	TM1-9406018X-WM					
								25 W	28 W	36 V	700 mA	80	3000K	30°	3800lm	3100lm	TM2-8303025X-WM
														60°	3800lm	2700lm	TM2-8306025X-WM
						4000K	30°							4000lm	3300lm	TM2-8403025X-WM	
							60°							4000lm	2900lm	TM2-8406025X-WM	
90	3000K	30°	3200lm	2700lm	TM2-9303025X-WM												
		60°	3200lm	2400lm	TM2-9306025X-WM												
		4000K	30°	3400lm	2900lm	TM2-9403025X-WM											
			60°	3400lm	2600lm	TM2-9406025X-WM											



18 W	21 W	36 V	500 mA	80	3000K	30°	2800lm	2300lm	TM1-8303018X-WW								
						60°	2800lm	2000lm	TM1-8306018X-WW								
						4000K	30°	3000lm	2500lm	TM1-8403018X-WW							
							60°	3000lm	2200lm	TM1-8406018X-WW							
						90	3000K	30°	2400lm	2000lm	TM1-9303018X-WW						
								60°	2400lm	1800lm	TM1-9306018X-WW						
								4000K	30°	2600lm	2200lm	TM1-9403018X-WW					
									60°	2600lm	1900lm	TM1-9406018X-WW					
								25 W	28 W	36 V	700 mA	80	3000K	30°	3800lm	3100lm	TM2-8303025X-WW
														60°	3800lm	2700lm	TM2-8306025X-WW
						4000K	30°							4000lm	3300lm	TM2-8403025X-WW	
							60°							4000lm	2900lm	TM2-8406025X-WW	
90	3000K	30°	3200lm	2700lm	TM2-9303025X-WW												
		60°	3200lm	2400lm	TM2-9306025X-WW												
		4000K	30°	3400lm	2900lm	TM2-9403025X-WW											
			60°	3400lm	2600lm	TM2-9406025X-WW											



Code Remark: X=F(ON-OFF) X=P(Phase Dim) X=A(1-10V Dim) X=D(DALI Dim)

LED Power	System Power	LED Voltage	LED Current	CRI	CCT	Beam	LED Output	System Output	Code								
18 W	21 W	36 V	500 mA	80	3000K	30°	2800lm	2300lm	TM1-8303018X-WB								
						60°	2800lm	2000lm	TM1-8306018X-WB								
						4000K	30°	3000lm	2500lm	TM1-8403018X-WB							
							60°	3000lm	2200lm	TM1-8406018X-WB							
						90	3000K	30°	2400lm	2000lm	TM1-9303018X-WB						
								60°	2400lm	1800lm	TM1-9306018X-WB						
								4000K	30°	2600lm	2200lm	TM1-9403018X-WB					
									60°	2600lm	1900lm	TM1-9406018X-WB					
								25 W	28 W	36 V	700 mA	80	3000K	30°	3800lm	3100lm	TM2-8303025X-WB
														60°	3800lm	2700lm	TM2-8306025X-WB
						4000K	30°							4000lm	3300lm	TM2-8403025X-WB	
							60°							4000lm	2900lm	TM2-8406025X-WB	
90	3000K	30°	3200lm	2700lm	TM2-9303025X-WB												
		60°	3200lm	2400lm	TM2-9306025X-WB												
		4000K	30°	3400lm	2900lm	TM2-9403025X-WB											
			60°	3400lm	2600lm	TM2-9406025X-WB											



Code Remark: X=F(ON-OFF) X=P(Phase Dim) X=A(1-10V Dim) X=D(DALI Dim)



**NEKO / TAKEO / T200**

**Fixed LED Downlight**

Super Eye Comfort  
High Efficiency

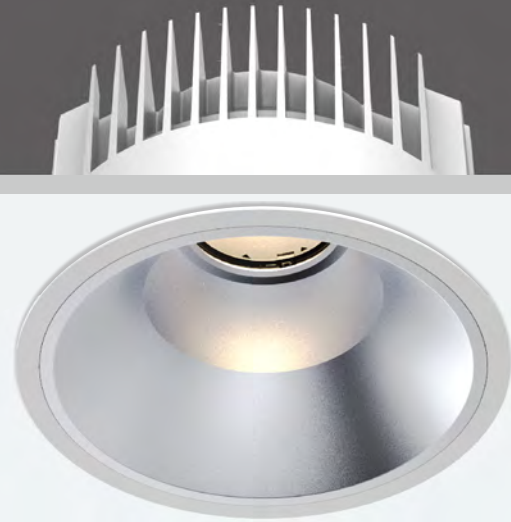

38W 52W	CRI80 CRI90	2700K 3000K 4000K	18° 30° 60°	<b>CITIZEN</b> 50,000h@L80B10	UGR < 19	IP54	<b>5</b> GUARANTEED	<b>CB</b>	<b>CE</b>
------------	----------------	-------------------------	-------------------	----------------------------------	-------------	------	------------------------	-----------	-----------



LED Power	System Power	LED Voltage	LED Current	CRI	CCT	Beam	LED Output	System Output	Code		
38 W	42 W	36 V	1050 mA	80	3000K	18°	5400lm	4400lm	TL2-8301838X-WM		
						30°	5400lm	4400lm	TL2-8303038X-WM		
						60°	5400lm	3900lm	TL2-8306038X-WM		
						4000K	18°	5600lm	4600lm	TL2-8401838X-WM	
							30°	5600lm	4600lm	TL2-8403038X-WM	
							60°	5600lm	4100lm	TL2-8406038X-WM	
						90°	3000K	18°	4600lm	3800lm	TL2-9301838X-WM
								30°	4600lm	3800lm	TL2-9303038X-WM
								60°	4600lm	3300lm	TL2-9306038X-WM
							4000K	18°	4800lm	3900lm	TL2-9401838X-WM
								30°	4800lm	3900lm	TL2-9403038X-WM
								60°	4800lm	3400lm	TL2-9406038X-WM
52 W	56 W	36 V	1400 mA	80	3000K	18°	6600lm	5400lm	TL3-8301852X-WM		
						30°	6600lm	5400lm	TL3-8303052X-WM		
						60°	6600lm	4800lm	TL3-8306052X-WM		
						4000K	18°	6800lm	5600lm	TL3-8401852X-WM	
							30°	6800lm	5600lm	TL3-8403052X-WM	
							60°	6800lm	5000lm	TL3-8406052X-WM	
						90°	3000K	18°	5600lm	4600lm	TL3-9301852X-WM
								30°	5600lm	4600lm	TL3-9303052X-WM
								60°	5600lm	4100lm	TL3-9306052X-WM
							4000K	18°	5800lm	4800lm	TL3-9401852X-WM
								30°	5800lm	4800lm	TL3-9403052X-WM
								60°	5800lm	4300lm	TL3-9406052X-WM
38 W	42 W	36 V	1050 mA	80	3000K	18°	5400lm	4400lm	TL2-8301838X-WW		
						30°	5400lm	4400lm	TL2-8303038X-WW		
						60°	5400lm	3900lm	TL2-8306038X-WW		
						4000K	18°	5600lm	4600lm	TL2-8401838X-WW	
							30°	5600lm	4600lm	TL2-8403038X-WW	
							60°	5600lm	4100lm	TL2-8406038X-WW	
						90°	3000K	18°	4600lm	3800lm	TL2-9301838X-WW
								30°	4600lm	3800lm	TL2-9303038X-WW
								60°	4600lm	3300lm	TL2-9306038X-WW
							4000K	18°	4800lm	3900lm	TL2-9401838X-WW
								30°	4800lm	3900lm	TL2-9403038X-WW
								60°	4800lm	3400lm	TL2-9406038X-WW
52 W	56 W	36 V	1400 mA	80	3000K	18°	6600lm	5400lm	TL3-8301852X-WW		
						30°	6600lm	5400lm	TL3-8303052X-WW		
						60°	6600lm	4800lm	TL3-8306052X-WW		
						4000K	18°	6800lm	5600lm	TL3-8401852X-WW	
							30°	6800lm	5600lm	TL3-8403052X-WW	
							60°	6800lm	5000lm	TL3-8406052X-WW	
						90°	3000K	18°	5600lm	4600lm	TL3-9301852X-WW
								30°	5600lm	4600lm	TL3-9303052X-WW
								60°	5600lm	4100lm	TL3-9306052X-WW
							4000K	18°	5800lm	4800lm	TL3-9401852X-WW
								30°	5800lm	4800lm	TL3-9403052X-WW
								60°	5800lm	4300lm	TL3-9406052X-WW



Matt Reflector



White Reflector



Black Reflector

LED Power	System Power	LED Voltage	LED Current	CRI	CCT	Beam	LED Output	System Output	Code		
38 W	42 W	36 V	1050 mA	80	3000K	18°	5400lm	4400lm	TL2-8301838X-WB		
						30°	5400lm	4400lm	TL2-8303038X-WB		
						60°	5400lm	3900lm	TL2-8306038X-WB		
						4000K	18°	5600lm	4600lm	TL2-8401838X-WB	
							30°	5600lm	4600lm	TL2-8403038X-WB	
							60°	5600lm	4100lm	TL2-8406038X-WB	
						90°	3000K	18°	4600lm	3800lm	TL2-9301838X-WB
								30°	4600lm	3800lm	TL2-9303038X-WB
								60°	4600lm	3300lm	TL2-9306038X-WB
							4000K	18°	4800lm	3900lm	TL2-9401838X-WB
								30°	4800lm	3900lm	TL2-9403038X-WB
								60°	4800lm	3400lm	TL2-9406038X-WB
52 W	56 W	36 V	1400 mA	80	3000K	18°	6600lm	5400lm	TL3-8301852X-WB		
						30°	6600lm	5400lm	TL3-8303052X-WB		
						60°	6600lm	4800lm	TL3-8306052X-WB		
						4000K	18°	6800lm	5600lm	TL3-8401852X-WB	
							30°	6800lm	5600lm	TL3-8403052X-WB	
							60°	6800lm	5000lm	TL3-8406052X-WB	
						90°	3000K	18°	5600lm	4600lm	TL3-9301852X-WB
								30°	5600lm	4600lm	TL3-9303052X-WB
								60°	5600lm	4100lm	TL3-9306052X-WB
							4000K	18°	5800lm	4800lm	TL3-9401852X-WB
								30°	5800lm	4800lm	TL3-9403052X-WB
								60°	5800lm	4300lm	TL3-9406052X-WB

Code Remark: X=F(ON-OFF) X=P(Phase Dim) X=A(1-10V Dim) X=D(DALI Dim)



Fixture can be taken off from the back of the ceiling, which is easy and convenient for maintenance.



**NEKO / TAKEO / T150C**

**TAKEO150 Ceiling Light**

Super Eye Comfort  
High Efficiency



**NEKO / TAKEO / T150C**

**Ceiling Light**  
Super Eye Comfort  
High Efficiency



25W CRI80 2700K 30° 60° CITIZEN UGR < 19 IP20 5 YEAR GUARANTEE CB CE

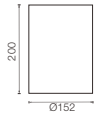

LED Power	System Power	LED Voltage	LED Current	CRI	CCT	Beam	LED Output	System Output	Code				
18 W	21 W	36 V	500 mA	80	3000K	30°	2800lm	2300lm	TMC1-8303018X-BM				
						60°	2800lm	2000lm	TMC1-8306018X-BM				
					4000K	30°	3000lm	2500lm	TMC1-8403018X-BM				
						60°	3000lm	2200lm	TMC1-8406018X-BM				
					90	3000K	30°	2400lm	2000lm	TMC1-9303018X-BM			
							60°	2400lm	1800lm	TMC1-9306018X-BM			
				4000K	30°	2600lm	2200lm	TMC1-9403018X-BM					
					60°	2600lm	1900lm	TMC1-9406018X-BM					
				25 W	28 W	36 V	700 mA	80	3000K	30°	3800lm	3100lm	TMC2-8303025X-BM
										60°	3800lm	2700lm	TMC2-8306025X-BM
									4000K	30°	4000lm	3300lm	TMC2-8403025X-BM
										60°	4000lm	2900lm	TMC2-8406025X-BM
90	3000K	30°	3200lm						2700lm	TMC2-9303025X-BM			
		60°	3200lm						2400lm	TMC2-9306025X-BM			
4000K	30°	3400lm	2900lm					TMC2-9403025X-BM					
	60°	3400lm	2600lm					TMC2-9406025X-BM					
18 W	21 W	36 V	500 mA					80	3000K	30°	2800lm	2300lm	TMP1-8303018X-WM
										60°	2800lm	2000lm	TMP1-8306018X-WM
									4000K	30°	3000lm	2500lm	TMP1-8403018X-WM
										60°	3000lm	2200lm	TMP1-8406018X-WM
				90	3000K	30°	2400lm		2000lm	TMP1-9303018X-WM			
						60°	2400lm		1800lm	TMP1-9306018X-WM			
				4000K	30°	2600lm	2200lm	TMP1-9403018X-WM					
					60°	2600lm	1900lm	TMP1-9406018X-WM					
				25 W	28 W	36 V	700 mA	80	3000K	30°	3800lm	3100lm	TMP2-8303025X-WM
										60°	3800lm	2700lm	TMP2-8306025X-WM
									4000K	30°	4000lm	3300lm	TMP2-8403025X-WM
										60°	4000lm	2900lm	TMP2-8406025X-WM
90	3000K	30°	3200lm						2700lm	TMP2-9303025X-WM			
		60°	3200lm						2400lm	TMP2-9306025X-WM			
4000K	30°	3400lm	2900lm					TMP2-9403025X-WM					
	60°	3400lm	2600lm					TMP2-9406025X-WM					



Matt Reflector



Matt Reflector



Black Reflector

White Reflector

Matt Reflector

Code Remark: X=F(ON-OFF) X=P(Phase Dim) X=A(1-10V Dim) X=D(DALI Dim)



**NEKO / TAKEO**  
Fixed LED Downlight  
Super Eye Comfort  
High Efficiency

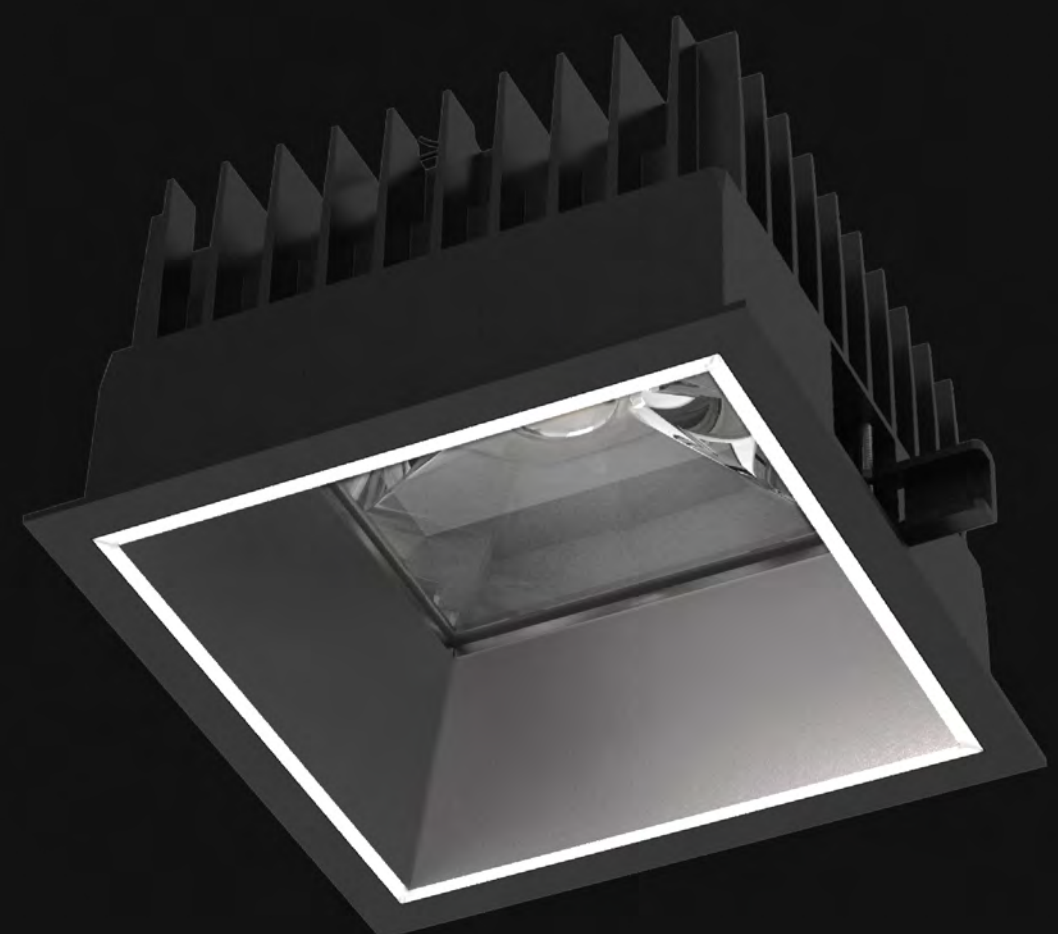

TAKEO TS100



TAKEO TS150



TAKEO TS200



100X100

4"



150X150

6"



200X200

8"

- Interchangeable Design
- Super Eye Comfort
- UGR<15
- IP54
- High Efficiency

# TAKEO/TS100

LED Downlight



# TAKEO/TS150

LED Downlight



9 W CRI90 2700K 3000K 4000K  
 13W CRI80 4000K  
  
 CITIZEN 50,000h@L80B10 UGR < 19  
 IP54  
  
 CB CE

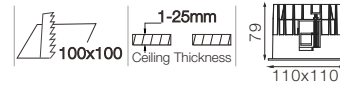

18W CRI90 2700K 3000K 4000K  
 25W CRI80 4000K  
  
 CITIZEN 50,000h@L80B10 UGR < 19  
 IP54  
  
 CB CE

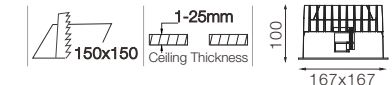

LED Power	System Power	LED Voltage	LED Current	CRI	CCT	Beam	LED Output	System Output	Code		
9 W	11 W	36 V	250 mA	80	3000K	60°	1300lm	900lm	TSS1-8306009X-WM		
						60°	1400lm	1000lm	TSS1-8406009X-WM		
						90	3000K	60°	1100lm	800lm	TSS1-9306009X-WM
						4000K	60°	1200lm	850lm	TSS1-9406009X-WM	
13 W	15 W	36 V	350 mA	80	3000K	60°	1800lm	1200lm	TSS2-8306013X-WM		
						60°	1900lm	1300lm	TSS2-8406013X-WM		
						90	3000K	60°	1500lm	1100lm	TSS2-9306013X-WM
						4000K	60°	1600lm	1200lm	TSS2-9406013X-WM	
9 W	11 W	36 V	250 mA	80	3000K	60°	1300lm	900lm	TSS1-8306009X-WW		
						60°	1400lm	1000lm	TSS1-8406009X-WW		
						90	3000K	60°	1100lm	800lm	TSS1-9306009X-WW
						4000K	60°	1200lm	850lm	TSS1-9406009X-WW	
13 W	15 W	36 V	350 mA	80	3000K	60°	1800lm	1200lm	TSS2-8306013X-WW		
						60°	1900lm	1300lm	TSS2-8406013X-WW		
						90	3000K	60°	1500lm	1100lm	TSS2-9306013X-WW
						4000K	60°	1600lm	1200lm	TSS2-9406013X-WW	
9 W	11 W	36 V	250 mA	80	3000K	60°	1300lm	900lm	TSS1-8306009X-WB		
						60°	1400lm	1000lm	TSS1-8406009X-WB		
						90	3000K	60°	1100lm	800lm	TSS1-9306009X-WB
						4000K	60°	1200lm	850lm	TSS1-9406009X-WB	
13 W	15 W	36 V	350 mA	80	3000K	60°	1800lm	1200lm	TSS2-8306013X-WB		
						60°	1900lm	1300lm	TSS2-8406013X-WB		
						90	3000K	60°	1500lm	1100lm	TSS2-9306013X-WB
						4000K	60°	1600lm	1200lm	TSS2-9406013X-WB	

Code Remark: X=F(ON-OFF) X=P(Phase Dim) X=A(1-10V Dim) X=D(DALI Dim)



LED Power	System Power	LED Voltage	LED Current	CRI	CCT	Beam	LED Output	System Output	Code		
18 W	21 W	36 V	500 mA	80	3000K	70°	2800lm	1700lm	TSM1-8307018X-WM		
						70°	3000lm	1800lm	TSM1-8407018X-WM		
						90	3000K	70°	2400lm	1500lm	TSM1-9307018X-WM
						4000K	70°	2600lm	1600lm	TSM1-9407018X-WM	
25 W	28 W	36 V	700 mA	80	3000K	70°	3800lm	2400lm	TSM2-8307025X-WM		
						70°	4000lm	2600lm	TSM2-8407025X-WM		
						90	3000K	70°	3200lm	2100lm	TSM2-9307025X-WM
						4000K	70°	3400lm	2300lm	TSM2-9407025X-WM	
18 W	21 W	36 V	500 mA	80	3000K	70°	2800lm	1700lm	TSM1-8307018X-WW		
						70°	3000lm	1800lm	TSM1-8407018X-WW		
						90	3000K	70°	2400lm	1500lm	TSM1-9307018X-WW
						4000K	70°	2600lm	1600lm	TSM1-9407018X-WW	
25 W	28 W	36 V	700 mA	80	3000K	70°	3800lm	2400lm	TSM2-8307025X-WW		
						70°	4000lm	2600lm	TSM2-8407025X-WW		
						90	3000K	70°	3200lm	2100lm	TSM2-9307025X-WW
						4000K	70°	3400lm	2300lm	TSM2-9407025X-WW	
18 W	21 W	36 V	500 mA	80	3000K	70°	2800lm	1700lm	TSM1-8307018X-WB		
						70°	3000lm	1800lm	TSM1-8407018X-WB		
						90	3000K	70°	2400lm	1500lm	TSM1-9307018X-WB
						4000K	70°	2600lm	1600lm	TSM1-9407018X-WB	
25 W	28 W	36 V	700 mA	80	3000K	70°	3800lm	2400lm	TSM2-8307025X-WB		
						70°	4000lm	2600lm	TSM2-8407025X-WB		
						90	3000K	70°	3200lm	2100lm	TSM2-9307025X-WB
						4000K	70°	3400lm	2300lm	TSM2-9407025X-WB	

Code Remark: X=F(ON-OFF) X=P(Phase Dim) X=A(1-10V Dim) X=D(DALI Dim)





# TAKEO/TS200

## LED Downlight

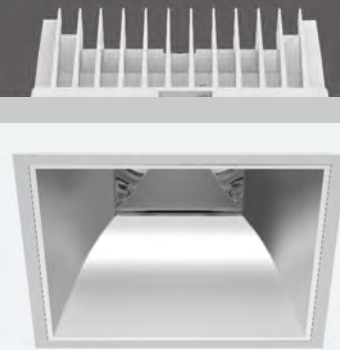

25W CRI90 2700K  
38W CRI80 3000K  
4000K

**70°**

**CITIZEN**  
50,000h@L80B10



**UGR**  
< 19

**IP54**

**5**  
GUARANTEE

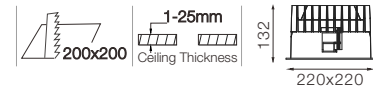
**CB CE**



	LED Power	System Power	LED Voltage	LED Current	CRI	CCT	Beam	LED Output	System Output	Code	
 Matt Reflector	25 W	28 W	36 V	700 mA	80	3000K	70°	3000lm	2200lm	TSL1-8307025X-WM	
						4000K	70°	3200lm	2400lm	TSL1-8407025X-WM	
	38 W	42 W	36 V	1050 mA	80	3000K	70°	2600lm	1900lm	TSL1-9307025X-WM	
						4000K	70°	2800lm	2100lm	TSL1-9407025X-WM	
		38 W	42 W	36 V	1050 mA	80	3000K	70°	4300lm	3200lm	TSL2-8307038X-WM
							4000K	70°	4500lm	3400lm	TSL2-8407038X-WM
	38 W	42 W	36 V	1050 mA	80	3000K	70°	3700lm	2700lm	TSL2-9307038X-WM	
						4000K	70°	3900lm	2900lm	TSL2-9407038X-WM	
 White Reflector	25 W	28 W	36 V	700 mA	80	3000K	70°	3000lm	2200lm	TSL1-8307025X-WW	
						4000K	70°	3200lm	2400lm	TSL1-8407025X-WW	
	38 W	42 W	36 V	1050 mA	80	3000K	70°	2600lm	1900lm	TSL1-9307025X-WW	
						4000K	70°	2800lm	2100lm	TSL1-9407025X-WW	
		38 W	42 W	36 V	1050 mA	80	3000K	70°	4300lm	3200lm	TSL2-8307038X-WW
							4000K	70°	4500lm	3400lm	TSL2-8407038X-WW
	38 W	42 W	36 V	1050 mA	80	3000K	70°	3700lm	2700lm	TSL2-9307038X-WW	
						4000K	70°	3900lm	2900lm	TSL2-9407038X-WW	
 Black Reflector	25 W	28 W	36 V	700 mA	80	3000K	70°	3000lm	2200lm	TSL1-8307025X-WB	
						4000K	70°	3200lm	2400lm	TSL1-8407025X-WB	
	38 W	42 W	36 V	1050 mA	80	3000K	70°	2600lm	1900lm	TSL1-9307025X-WB	
						4000K	70°	2800lm	2100lm	TSL1-9407025X-WB	
		38 W	42 W	36 V	1050 mA	80	3000K	70°	4300lm	3200lm	TSL2-8307038X-WB
							4000K	70°	4500lm	3400lm	TSL2-8407038X-WB
	38 W	42 W	36 V	1050 mA	80	3000K	70°	3700lm	2700lm	TSL2-9307038X-WB	
						4000K	70°	3900lm	2900lm	TSL2-9407038X-WB	

Code Remark: X=F(ON-OFF) X=P(Phase Dim) X=A(1-10V Dim) X=D(DALI Dim)



**NEKO / SIGN-G**  
Minimal LED Downlight

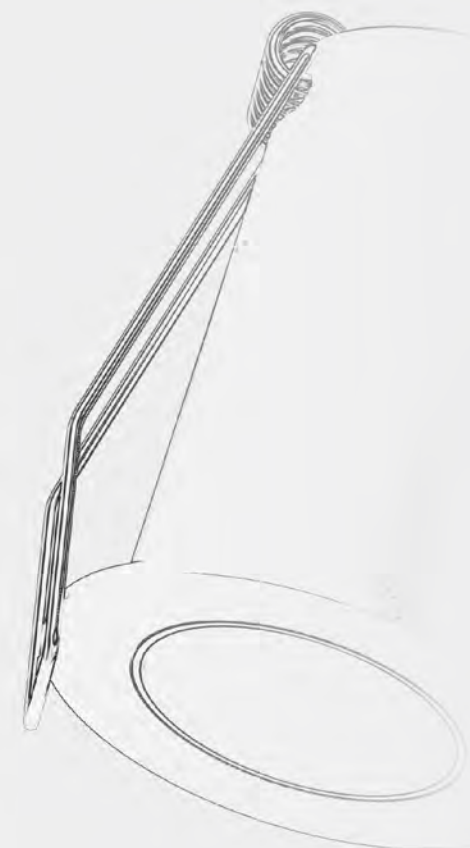

**SIGN-G**  
Minimal LED Downlight



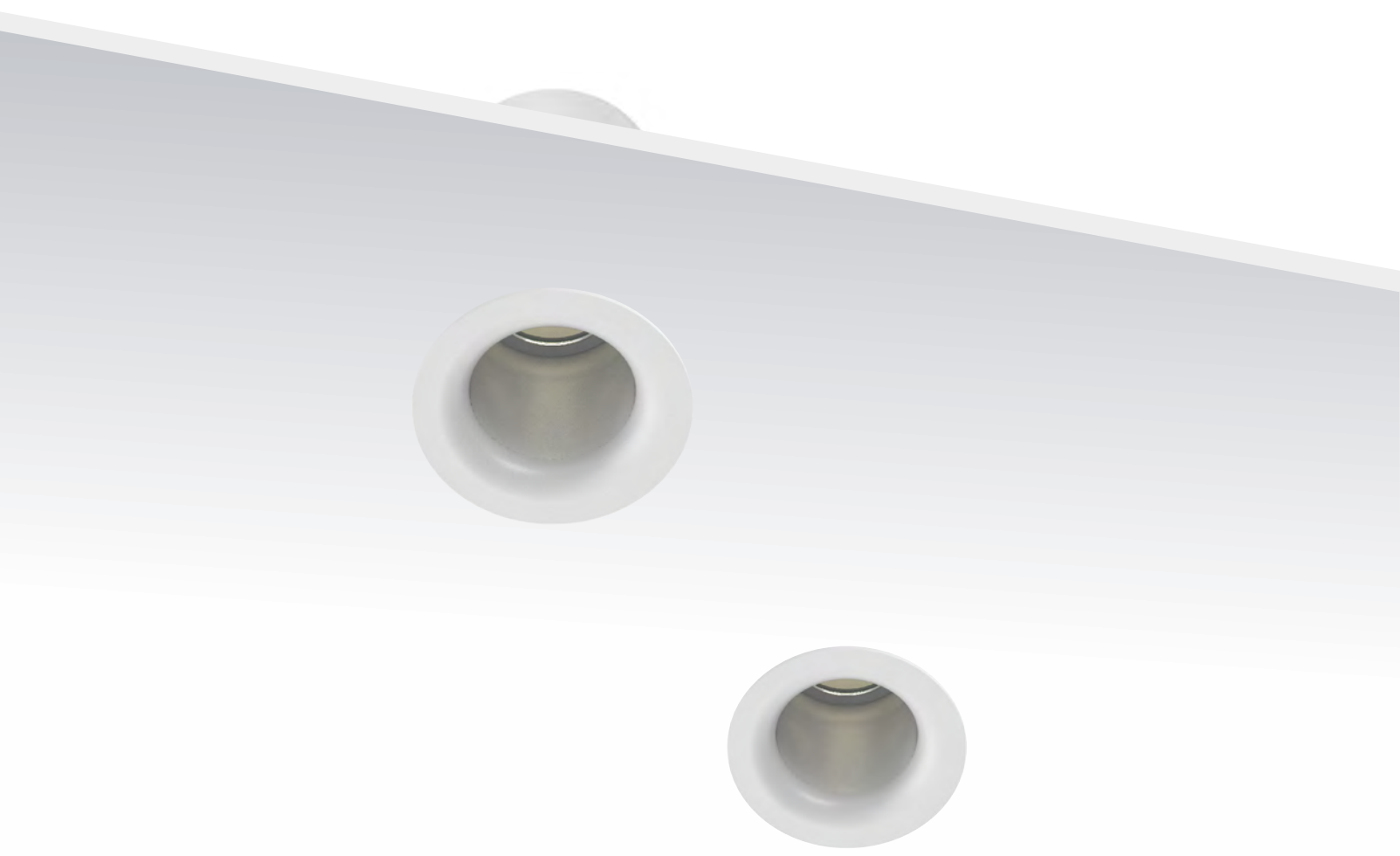

SIGN-G



SIGN35-G



SIGN45-G

Color



White

Black

**NEKO / SIGN35-G**  
Minimal LED Downlight

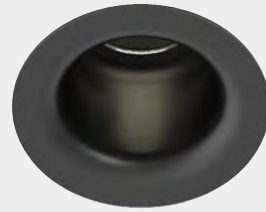

**NEKO / SIGN45-G**  
Minimal LED Downlight



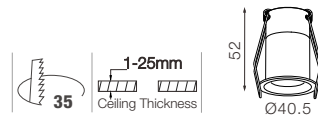

1.5W CRI80 CRI90 2700K 3000K 4000K 18° 30° IP20 UGR < 19 CREE 50,000h@L80 5 YEARS GUARANTEE CE

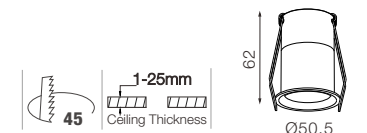

6W CRI80 CRI90 2700K 3000K 4000K 30° IP20 UGR < 19 LUMINUS 50,000h@L80 5 YEARS GUARANTEE CE



	LED Power	System Power	LED Voltage	LED Current	CRI	CCT	Beam	LED Output	System Output	Code	
 White	1.5 W	2.5 W	3.2 V	500 mA	80	2700K	18°	140lm	100lm	S3G-8271802X-WN	
							30°	140lm	100lm	S3G-8273002X-WN	
							3000K	18°	150lm	110lm	S3G-8301802X-WN
								30°	150lm	110lm	S3G-8303002X-WN
							4000K	18°	160lm	120lm	S3G-8401802X-WN
								30°	160lm	120lm	S3G-8403002X-WN
	90	2700K	18°	120lm	85lm	S3G-9271802X-WN					
				30°	120lm	85lm	S3G-9273002X-WN				
				3000K	18°	130lm	95lm	S3G-9301802X-WN			
					30°	130lm	95lm	S3G-9303002X-WN			
				4000K	18°	140lm	105lm	S3G-9401802X-WN			
					30°	140lm	105lm	S3G-9403002X-WN			
 Black	1.5 W	2.5 W	3.2 V	500 mA	80	2700K	18°	140lm	100lm	S3G-8271802X-BN	
							30°	140lm	100lm	S3G-8273002X-BN	
							3000K	18°	150lm	110lm	S3G-8301802X-BN
								30°	150lm	110lm	S3G-8303002X-BN
							4000K	18°	160lm	120lm	S3G-8401802X-BN
								30°	160lm	120lm	S3G-8403002X-BN
	90	2700K	18°	120lm	85lm	S3G-9271802X-BN					
				30°	120lm	85lm	S3G-9273002X-BN				
				3000K	18°	130lm	95lm	S3G-9301802X-BN			
					30°	130lm	95lm	S3G-9303002X-BN			
				4000K	18°	140lm	105lm	S3G-9401802X-BN			
					30°	140lm	105lm	S3G-9403002X-BN			

Remark: X= F (ON-OFF) X= P (Phase Dim) X= A (1-10V Dim) X= D (DALI Dim)

**Features**



-Easy for installation

	LED Power	System Power	LED Voltage	LED Current	CRI	CCT	Beam	LED Output	System Output	Code		
 White	6 W	8 W	18 V	350 mA	80	2700K	30°	520lm	400lm	S4G-8273006X-WN		
							3000K	30°	550lm	420lm	S4G-8303006X-WN	
							4000K	30°	600lm	450lm	S4G-8403006X-WN	
							90	2700K	30°	450lm	350lm	S4G-9273006X-WN
								3000K	30°	480lm	370lm	S4G-9303006X-WN
								4000K	30°	520lm	400lm	S4G-9403006X-WN
	6 W	8 W	18 V	350 mA	80	2700K	30°	520lm	400lm	S4G-8273006X-BN		
							3000K	30°	550lm	420lm	S4G-8303006X-BN	
							4000K	30°	600lm	450lm	S4G-8403006X-BN	
							90	2700K	30°	450lm	350lm	S4G-9273006X-BN
								3000K	30°	480lm	370lm	S4G-9303006X-BN
								4000K	30°	520lm	400lm	S4G-9403006X-BN

Remark: X= F (ON-OFF) X= P (Phase Dim) X= A (1-10V Dim) X= D (DALI Dim)

**Features**



-Easy for installation



**NEKO / MR16**  
**LED Downlight Module**

- The NEKO LED module is a perfect replacement for MR16 halogen modules.
- Smart and elegant design.
- Versatile for downlight and spotlight applications.
- Uniform color for all LED modules within 3 MacAdam steps.
- You can use NEKO LED modules in various fixture designs with no color variability.
- Outstanding lumen output, excellent lumen maintenance.
- 50,000-hour lifetime eliminates frequent re-lamping.
- NEKO 5-Year Quality Guarantee



- NEKO LED-Module sind die perfekte Austauschlösung für MR16 Halogen.
- Sehr schickes und elegantes Design und vielfältig einsetzbar bei Downlight- und Spotanwendungen.
- Hohe Farbkonsistenz bei allen LED-Modulen innerhalb einer 3-Step-MacAdam-Ellipse. Neko-LED-Module können in verschiedenen Leuchten verwendet werden, ohne Einfluss auf die Farbkonsistenz.
- Hervorragende Lichtausbeute und exzellenter Lampenlichtstromerhalt mit 50.000 Stunden Lebensdauer machen häufige Lampenwechsel zu einem Relikt der Vergangenheit.
- 5 Jahre Qualitätsgarantie von NEKO.

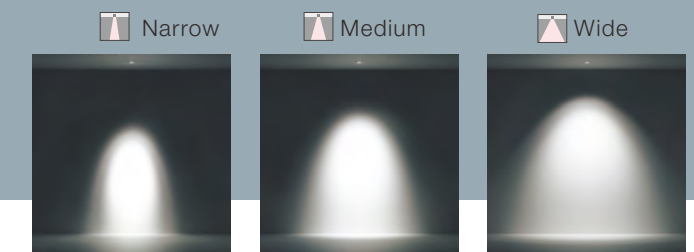

Verschiedene Abstrahlwinkel für architektonische Designs  
Three beam angles for various architectural design requirements.

**NEKO / M1**  
LED Downlight Module  
MR16 Replacement



**NEKO / M2**  
LED Downlight Module  
MR16 Replacement

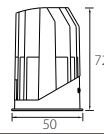
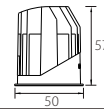

LED Power	System Power	LED Voltage	LED Current	CRI	CCT	Beam	LED Output	System Output	Code	
6 W	8 W	18 V	350 mA	80	2700K	20°	700lm	580lm	M1-8272006X-NN	
						40°	700lm	580lm	M1-8274006X-NN	
						60°	700lm	580lm	M1-8276006X-NN	
						3000K	20°	750lm	600lm	M1-8302006X-NN
							40°	750lm	600lm	M1-8304006X-NN
							60°	750lm	600lm	M1-8306006X-NN
	4000K	20°	800lm	650lm	M1-8402006X-NN					
		40°	800lm	650lm	M1-8404006X-NN					
		60°	800lm	650lm	M1-8406006X-NN					

Code Remark: X=F(ON-OFF) X=P(Phase Dim) X=A(1-10V Dim) X=D(DALI Dim)



LED Power	System Power	LED Voltage	LED Current	CRI	CCT	Beam	LED Output	System Output	Code	
9 W	11 W	27 V	350 mA	80	2700K	20°	1000lm	850lm	M2-8272009X-NN	
						40°	1000lm	850lm	M2-8274009X-NN	
						60°	1000lm	850lm	M2-8276009X-NN	
						3000K	20°	1100lm	900lm	M2-8302009X-NN
							40°	1100lm	900lm	M2-8304009X-NN
							60°	1100lm	900lm	M2-8306009X-NN
	4000K	20°	1200lm	950lm	M2-8402009X-NN					
		40°	1200lm	950lm	M2-8404009X-NN					
		60°	1200lm	950lm	M2-8406009X-NN					

Code Remark: X=F(ON-OFF) X=P(Phase Dim) X=A(1-10V Dim) X=D(DALI Dim)



Mounting Ring

TF1

TF1 Ring (White)  
Code Color  
P07-003 White

TF2

TF2 Ring (White)  
Code Reflector  
P07-004 White  
P07-008 Black  
P07-012 Specular  
P07-024 Matt

TA1

Ta1 Ring (White)  
Code Color  
P07-001 White

TA2

TA2 Ring (White)  
Code Reflector  
P07-002 White  
P07-006 Black  
P07-010 Specular  
P07-023 Matt

Mounting Ring

TF1

TF1 Ring (White)  
Code Color  
P07-003 White

TF2

TF2 Ring (White)  
Code Reflector  
P07-004 White  
P07-008 Black  
P07-012 Specular  
P07-024 Matt

TA1

Ta1 Ring (White)  
Code Color  
P07-001 White

TA2

TA2 Ring (White)  
Code Reflector  
P07-002 White  
P07-006 Black  
P07-010 Specular  
P07-023 Matt



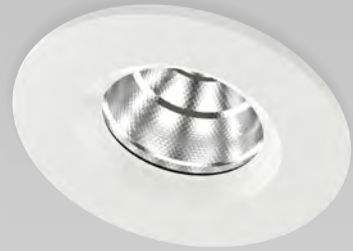

TF1



TF3



TF2



TF4



TA1



TA2



TA4



KA1



TA3

Square trim for shop lighting



X1



X2



X3

- Perfect choice for specified architectural projects
- Compatible with MR16 and LED Modules
- Wide range of design variants for different applications
- Available in trimless version
- Decorative rings painted in a variety of colors (black, white, marble, wood, etc.)
- Magnetic design for changing decorative ring without any tools

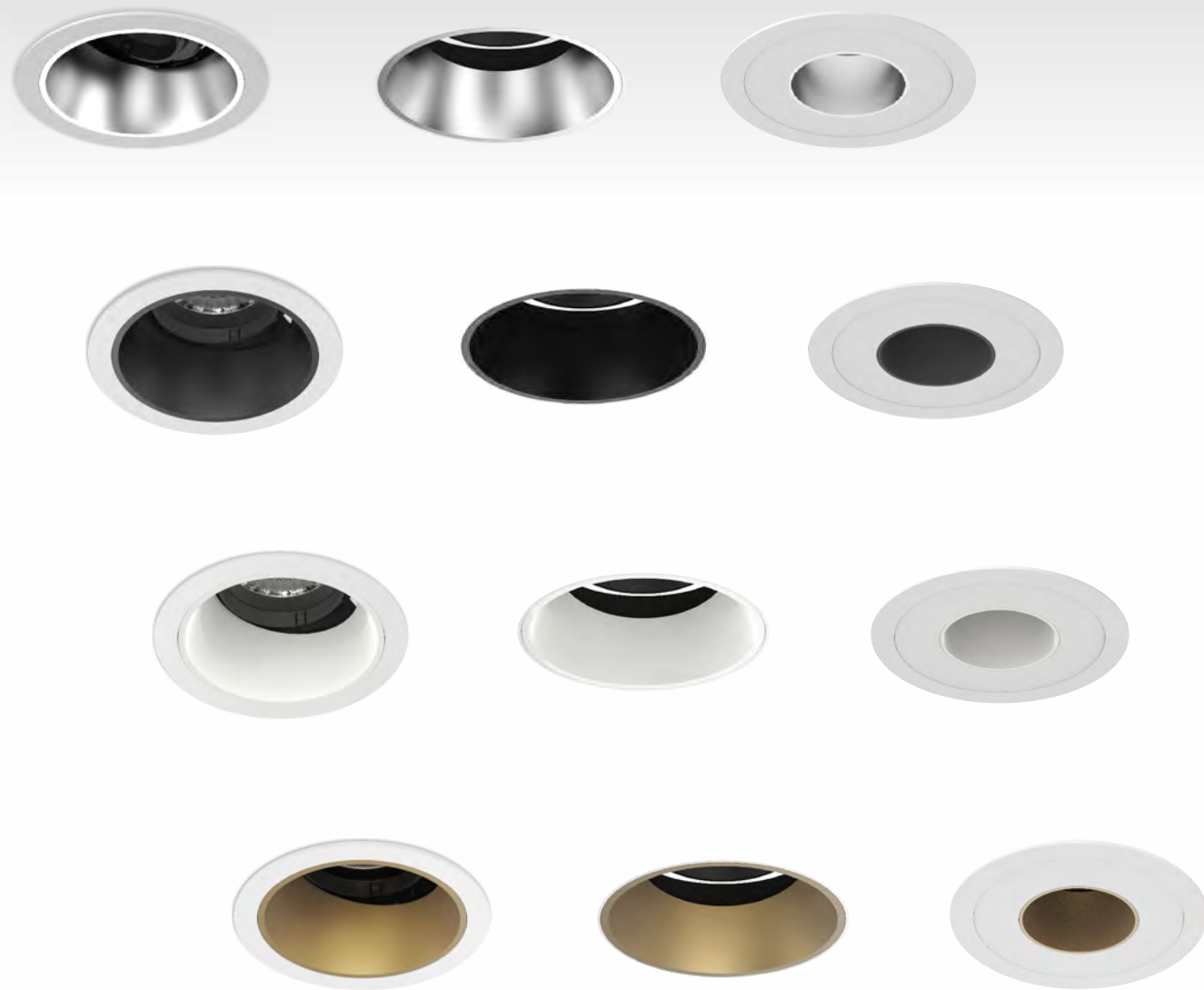

TA5

KA5

TA6



TSA1

KSA1



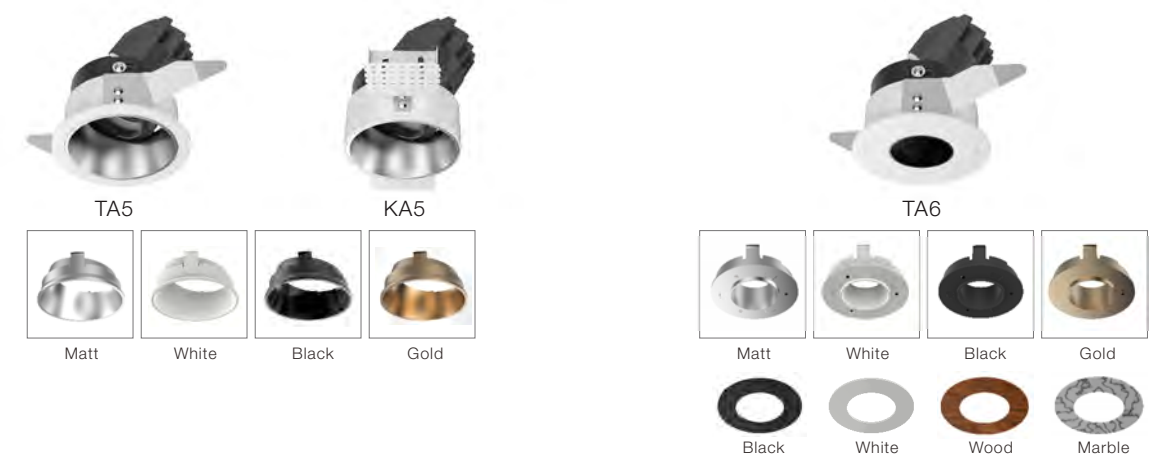
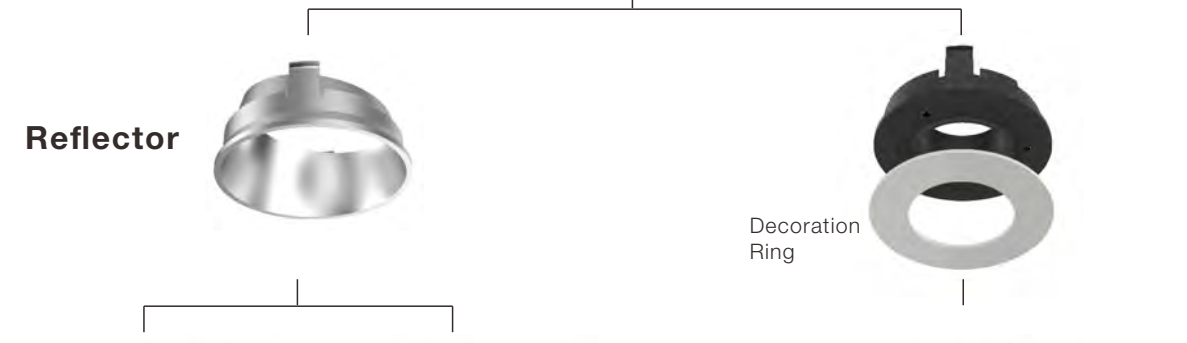
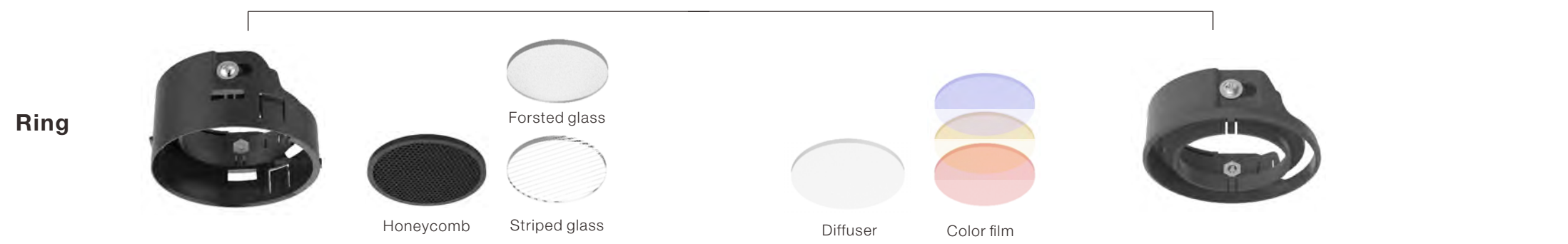

TA5

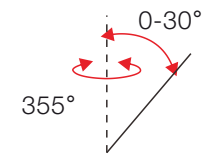
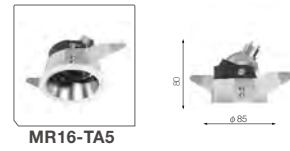
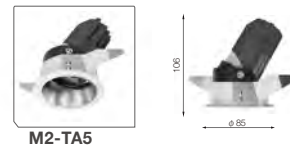

KA5

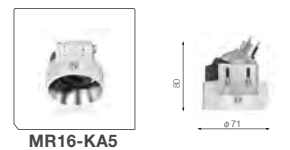
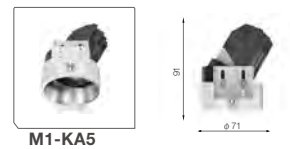

TA6

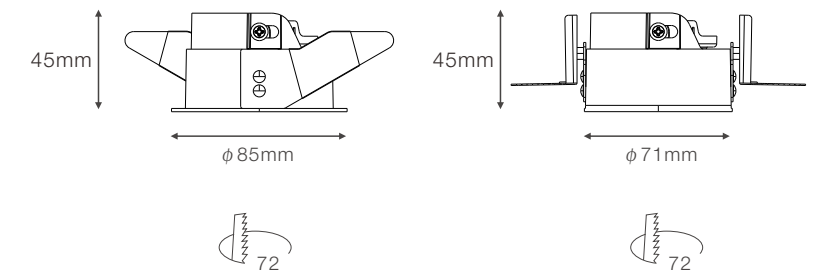
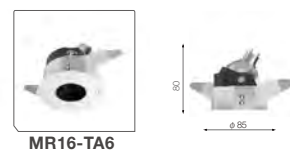
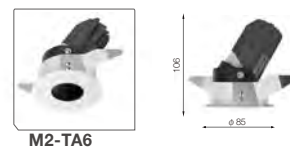
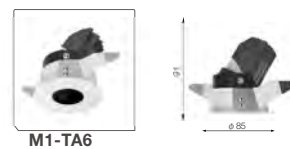



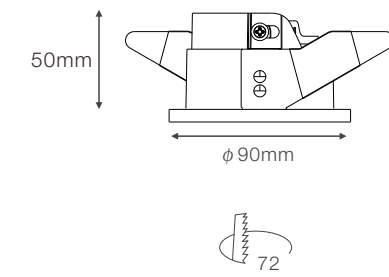

TSA1



M1-TSA1



M2-TSA1



MR16-TSA1



KSA1



M1-KSA1



M2-KSA1



MR16-KSA1

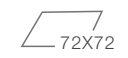
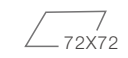
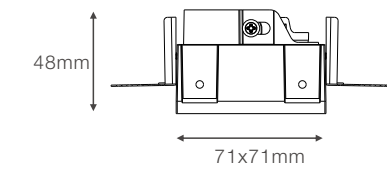
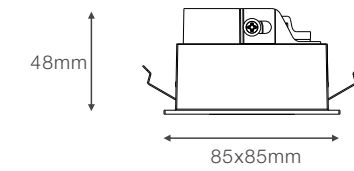
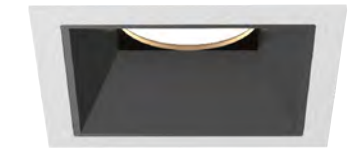
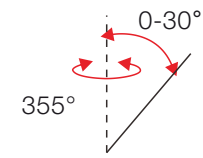



**NEKO / M3**  
LED Downlight Module



11W CRI90 2700K 15° 3000K 25° 4000K 35° 60°  
 Replace Halogen 50W UGR < 19 IP 20  
 CITIZEN 50,000h@L80B10  
 5 YEAR WARRANTY CB CE

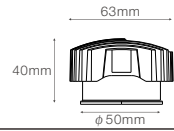

LED Power	System Power	LED Voltage	LED Current	CRI	CCT	Beam	LED Output	System Output	Code	
11 W	13 W	31 V	350 mA	90	2700K	15°	1000lm	900lm	M3- 927151X-BN	
						25°	1000lm	900lm	M3- 927251X-BN	
						35°	1000lm	900lm	M3- 927351X-BN	
						60°	1000lm	900lm	M3- 927601X-BN	
						3000K	15°	1100lm	950lm	M3- 930151X-BN
							25°	1100lm	950lm	M3- 930251X-BN
							35°	1100lm	950lm	M3- 930351X-BN
							60°	1100lm	950lm	M3- 930601X-BN
						4000K	15°	1200lm	1000lm	M3- 940151X-BN
							25°	1200lm	1000lm	M3- 940251X-BN
							35°	1200lm	1000lm	M3- 940351X-BN
							60°	1200lm	1000lm	M3- 940601X-BN



Code Remark: X=F(ON-OFF) X=P(Phase Dim) X=A(1-10V Dim) X=D(DALI Dim)

**Mounting Ring**

TA5	KA5	TA6	TSA1	KSA1
<b>TA5 Ring (White)</b> Code Reflector P07-042 White P07-041 Black P07-043 Gold P07-040 Matt	<b>KA5 Ring (White)</b> Code Reflector P07-054 White P07-053 Black P07-055 Gold P07-052 Matt	<b>TA6 Ring (White)</b> Code Reflector P07-046 White P07-045 Black P07-047 Gold P07-044 Matt	<b>TSA1 Ring (White)</b> Code Reflector P07-050 White P07-049 Black P07-051 Gold P07-048 Matt	<b>KSA1 Ring (White)</b> Code Reflector P07-058 White P07-057 Black P07-059 Gold P07-056 Matt

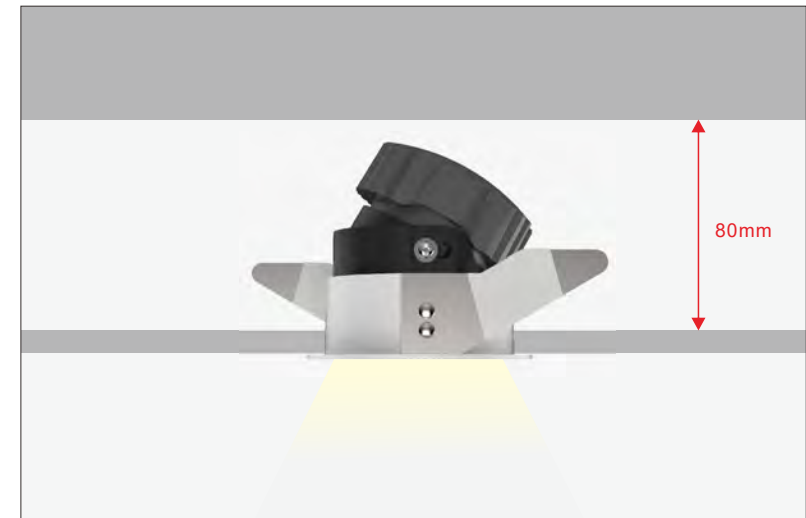

The minimal size can be used with limited ceiling space of 80mm height



## NEKO / FUSION Linear LED Downlight Series

- Hohe Lichtplanungsflexibilität mit verschiedenen Grössen von Lichtmodulen
- Schmale LED-Downlights für reinen Minimalismus
- Bester Blendschutz mit hoher Leistung und gutem Sehkomfort
- Fix und schwenkbar, Wall Washer, Allgemeinbeleuchtung, Spot und rahmenlose Version verfügbar
- 5 Jahre Garantie

- Create a circle of light from a line of LED Downlights
- A narrow line of nano LED Downlights for pure minimalism
- Superior glare control for high performance and visual comfort
- Fixed, Adjustable, Wall Washer, General light, Spotlight and trimless versions for choice
- Five-year guarantee

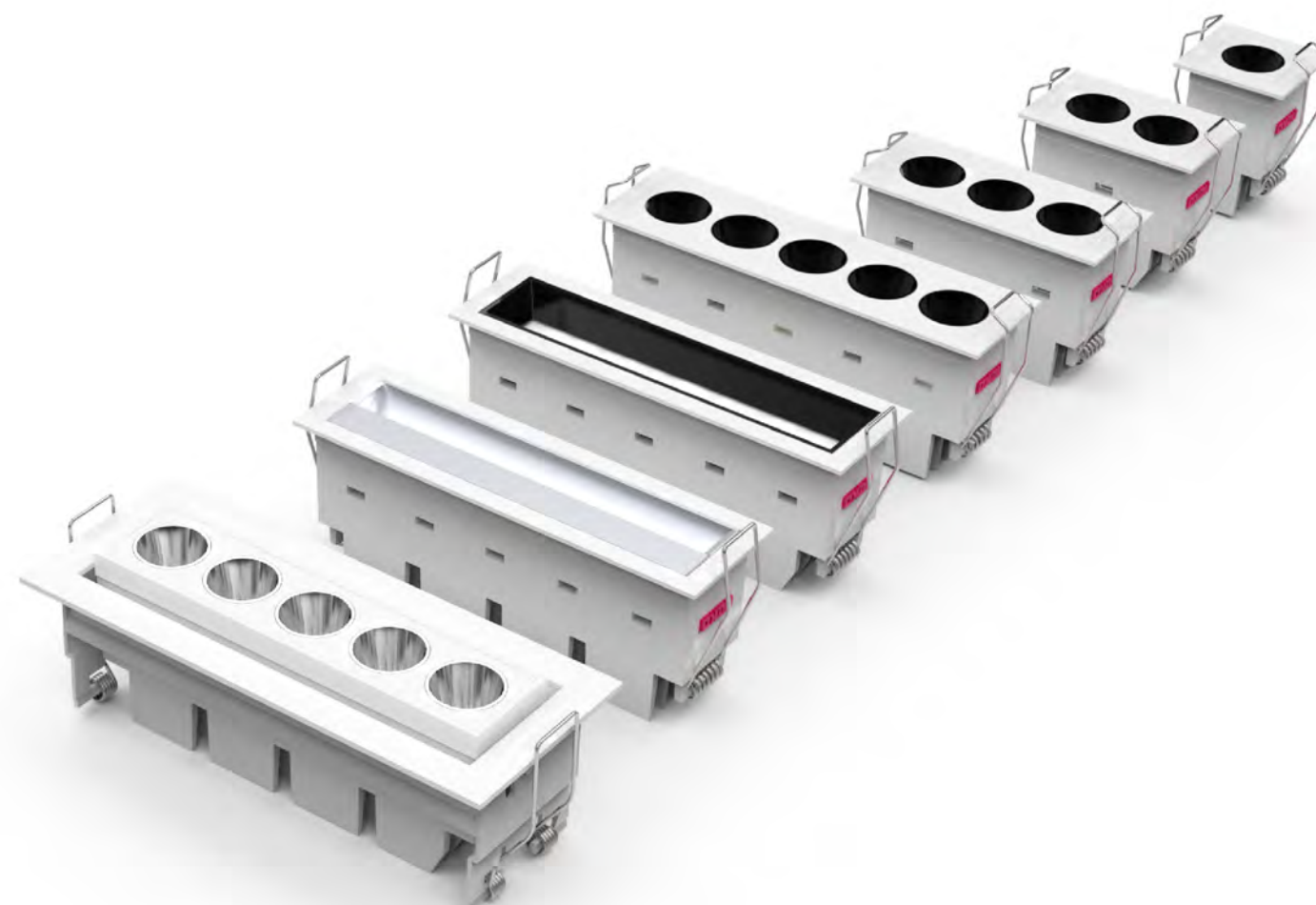
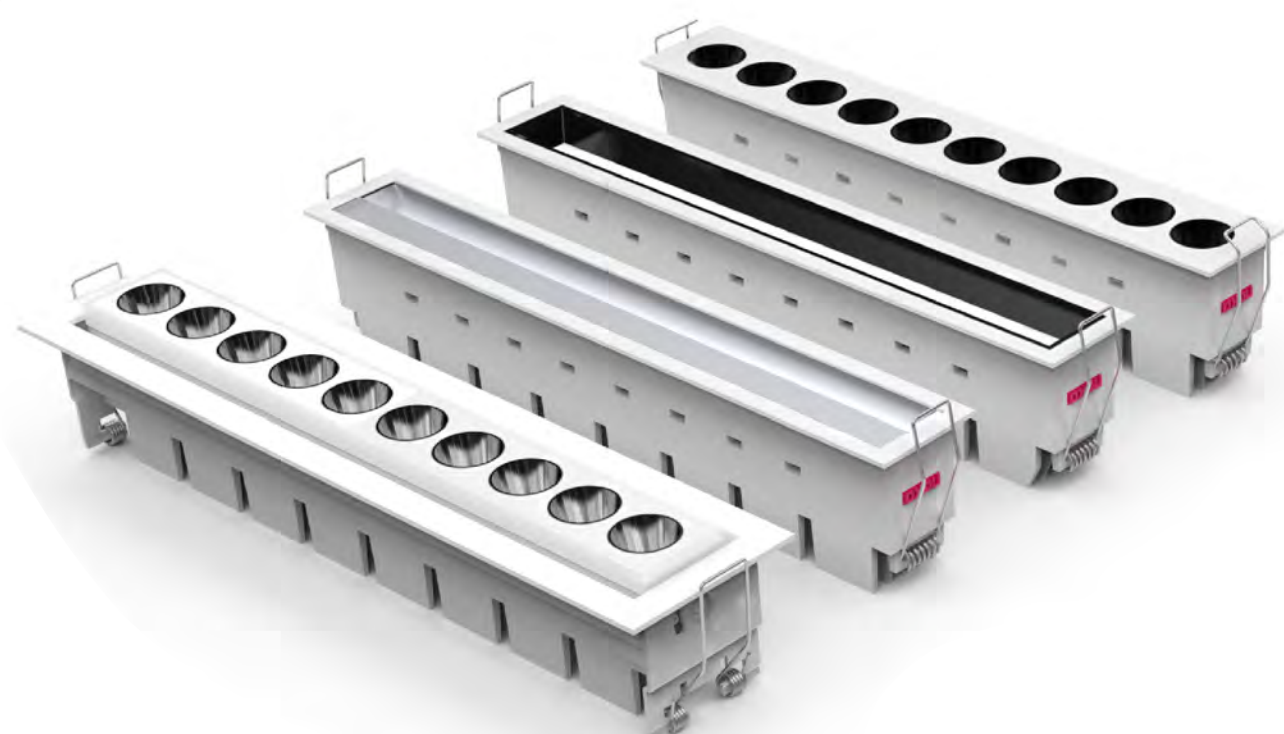



**NEKO / FUSION**  
Linear Downlight Series

FIXED

ADJUSTABLE

WALL WASHER

GENERAL LIGHT

SPOTLIGHT

TRIMLESS



37x37 FF1 / 1 LED / 2W / 170 lm



160x52 FA5 / 5 LED / 11W / 900 lm



144x37 FW5 / 5 LED / 11W / 600 lm



144x37 FG5 / 5 LED / 11W / 400 lm



62x37 FS1 / 1 LED / 2W / 170 lm



152x44 FFT5 / 5 LED / 11W / 900 lm



62x37 FF2 / 2 LED / 4W / 350 lm



296x52 FA10 / 10 LED / 22W / 1800 lm



282x37 FW10 / 10 LED / 22W / 1200 lm



282x37 FG10 / 10 LED / 22W / 950 lm



90x37 FS2 / 2 LED / 4W / 350 lm



290x44 FFT10 / 10 LED / 22W / 1800 lm



90x37 FF3 / 3 LED / 7W / 550 lm



144x37 FS3 / 3 LED / 7W / 550 lm



152x44 FWT5 / 5 LED / 11W / 600 lm



144x37 FF5 / 5 LED / 11W / 900 lm



144x37 FF3-FS1 / 4 LED / 9W / 700 lm



290x44 FWT10 / 10 LED / 22W / 1200 lm



282x37 FF10 / 10 LED / 22W / 1800 lm



282x37 FS6 / 6 LED / 14W / 1050 lm



152x44 FGT5 / 5 LED / 11W / 400 lm



282x37 FF6-FS2 / 8 LED / 18W / 1400 lm



290x44 FGT10 / 10 LED / 22W / 950 lm

Secondary Reflector

Beam



BLACK



SPECULAR



Medium 24°



Wide 40°

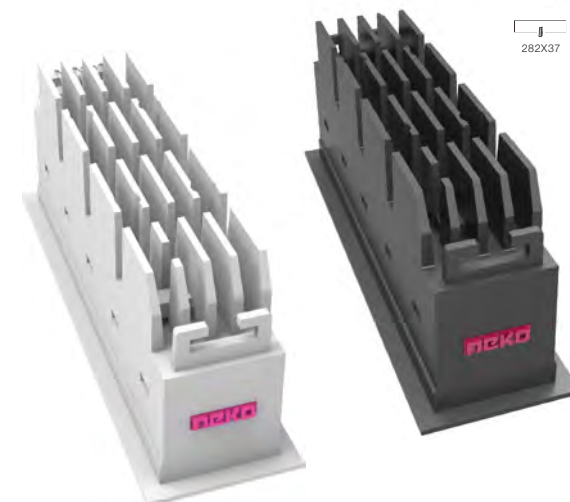

152x44 FS3 / 3 LED / 7W / 550 lm



290x44 FS6 / 6 LED / 14W / 1050 lm

**NEKO / FUSION**  
Fixed Series LED Downlight

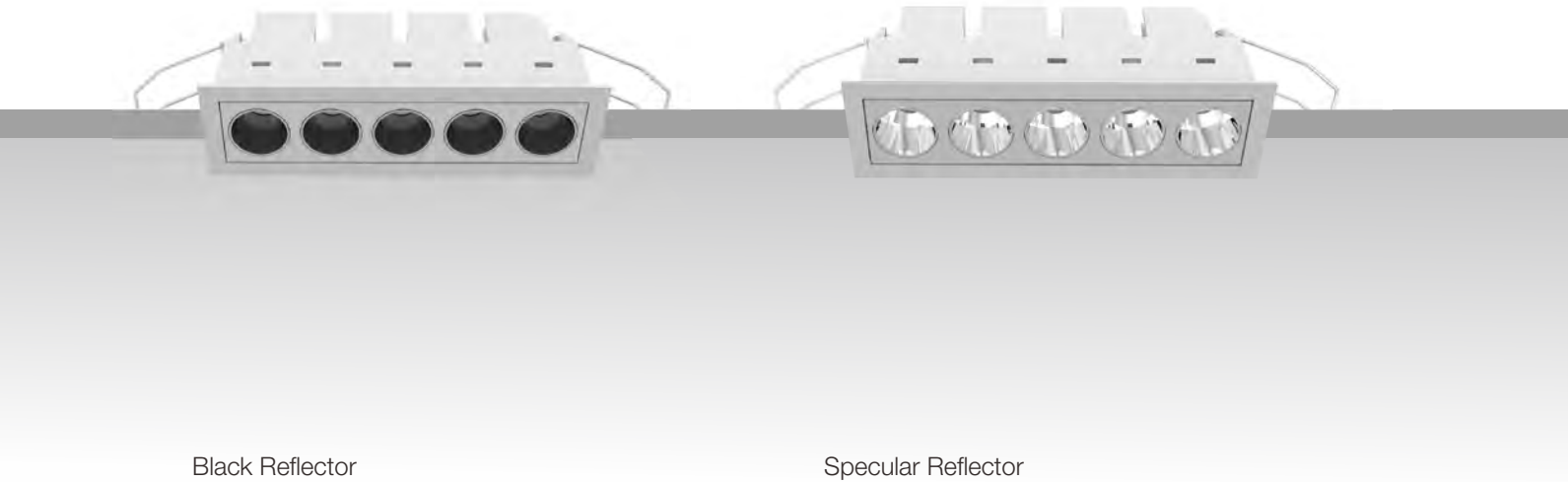

**Black Reflector**



1 LED / 2W / 170lm



2 LED / 4W / 350lm



3 LED / 7W / 550lm



5 LED / 11W / 900lm



10 LED / 22W / 1800lm

**Specular Reflector**



1 LED / 2W / 200lm



2 LED / 4W / 400lm



3 LED / 7W / 600lm



5 LED / 11W / 1050lm



10 LED / 22W / 2100lm

**Secondary Reflector**



Black



Specular

**Beam**

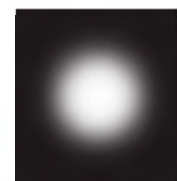

Medium 24°



Wide 40°

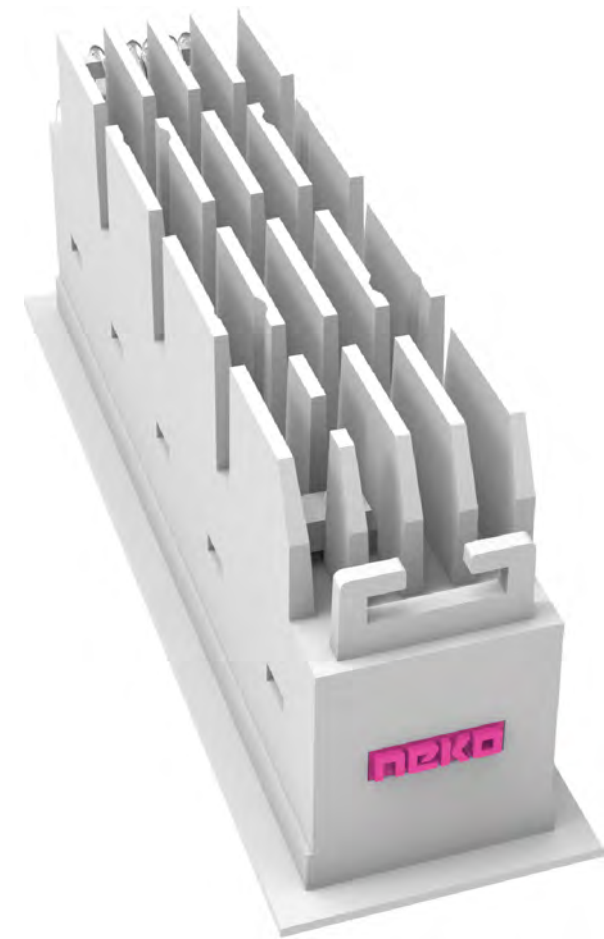
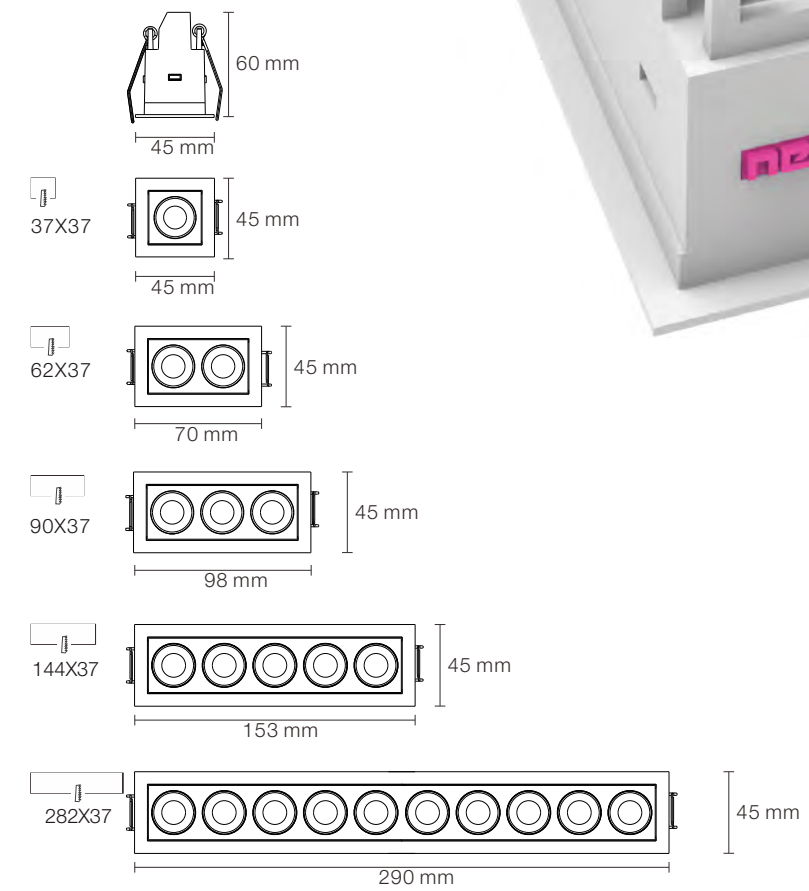







NEKO / FUSION / FF1  
Fixed LED Downlight

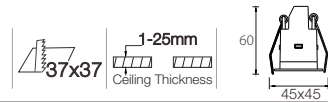

2W CR190 2700K 24° CREE UGR < 10 IP20 5 YEAR GUARANTEE CB CE UL LISTED







	LED Power	System Power	LED Voltage	LED Current	CRI	CCT	Beam	LED Output	System Output	Code	
 Black Reflector	2 W	3 W	3.5 V	700 mA	80	2700K	24°	220lm	160lm	FF1-8272402X-WB	
							40°	220lm	160lm	FF1-8274002X-WB	
							3000K	24°	250lm	170lm	FF1-8302402X-WB
								40°	250lm	170lm	FF1-8304002X-WB
							4000K	24°	280lm	180lm	FF1-8402402X-WB
								40°	280lm	180lm	FF1-8404002X-WB
 Black Reflector	2 W	3 W	3.5 V	700 mA	80	2700K	24°	220lm	160lm	FF1-8272402X-BB	
							40°	220lm	160lm	FF1-8274002X-BB	
							3000K	24°	250lm	170lm	FF1-8302402X-BB
								40°	250lm	170lm	FF1-8304002X-BB
							4000K	24°	280lm	180lm	FF1-8402402X-BB
								40°	280lm	180lm	FF1-8404002X-BB
 Specular Reflector	2 W	3 W	3.5 V	700 mA	80	2700K	24°	220lm	180lm	FF1-8272402X-WS	
							40°	220lm	180lm	FF1-8274002X-WS	
							3000K	24°	250lm	200lm	FF1-8302402X-WS
								40°	250lm	200lm	FF1-8304002X-WS
							4000K	24°	280lm	220lm	FF1-8402402X-WS
								40°	280lm	220lm	FF1-8404002X-WS
 Specular Reflector	2 W	3 W	3.5 V	700 mA	80	2700K	24°	220lm	180lm	FF1-8272402X-BS	
							40°	220lm	180lm	FF1-8274002X-BS	
							3000K	24°	250lm	200lm	FF1-8302402X-BS
								40°	250lm	200lm	FF1-8304002X-BS
							4000K	24°	280lm	220lm	FF1-8402402X-BS
								40°	280lm	220lm	FF1-8404002X-BS

Code Remark: X=F(ON-OFF) X=P(Phase Dim) X=A(1-10V Dim) X=D(DALI Dim)

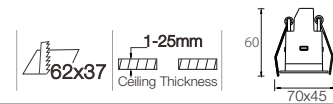

NEKO / FUSION / FF2  
Fixed LED Downlight



	LED Power	System Power	LED Voltage	LED Current	CRI	CCT	Beam	LED Output	System Output	Code	
 Black Reflector	4 W	6 W	6.5 V	700 mA	80	2700K	24°	450lm	330lm	FF2-8272404X-WB	
							40°	450lm	330lm	FF2-8274004X-WB	
							3000K	24°	500lm	350lm	FF2-8302404X-WB
								40°	500lm	350lm	FF2-8304004X-WB
							4000K	24°	550lm	380lm	FF2-8402404X-WB
								40°	550lm	380lm	FF2-8404004X-WB
 Black Reflector	4 W	6 W	6.5 V	700 mA	80	2700K	24°	450lm	330lm	FF2-8272404X-BB	
							40°	450lm	330lm	FF2-8274004X-BB	
							3000K	24°	500lm	350lm	FF2-8302404X-BB
								40°	500lm	350lm	FF2-8304004X-BB
							4000K	24°	550lm	380lm	FF2-8402404X-BB
								40°	550lm	380lm	FF2-8404004X-BB
 Specular Reflector	4 W	6 W	6.5 V	700 mA	80	2700K	24°	450lm	380lm	FF2-8272404X-WS	
							40°	450lm	380lm	FF2-8274004X-WS	
							3000K	24°	500lm	400lm	FF2-8302404X-WS
								40°	500lm	400lm	FF2-8304004X-WS
							4000K	24°	550lm	440lm	FF2-8402404X-WS
								40°	550lm	440lm	FF2-8404004X-WS
 Specular Reflector	4 W	6 W	6.5 V	700 mA	80	2700K	24°	450lm	380lm	FF2-8272404X-BS	
							40°	450lm	380lm	FF2-8274004X-BS	
							3000K	24°	500lm	400lm	FF2-8302404X-BS
								40°	500lm	400lm	FF2-8304004X-BS
							4000K	24°	550lm	440lm	FF2-8402404X-BS
								40°	550lm	440lm	FF2-8404004X-BS

Code Remark: X=F(ON-OFF) X=P(Phase Dim) X=A(1-10V Dim) X=D(DALI Dim)





NEKO / FUSION / FF3  
Fixed LED Downlight



7W CRI90 2700K 24° CREE UGR < 10 IP20 5 YEAR GUARANTEE CB CE UL LISTED

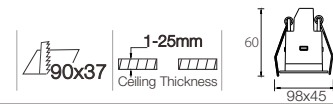

LED Power	System Power	LED Voltage	LED Current	CRI	CCT	Beam	LED Output	System Output	Code						
7 W	9 W	10 V	700 mA	80	2700K	24°	700lm	500lm	FF3-8272407X-WB						
						40°	700lm	500lm	FF3-8274007X-WB						
						3000K	24°	750lm	550lm	FF3-8302407X-WB					
							40°	750lm	550lm	FF3-8304007X-WB					
						4000K	24°	800lm	600lm	FF3-8402407X-WB					
							40°	800lm	600lm	FF3-8404007X-WB					
						7 W	9 W	10 V	700 mA	80	2700K	24°	700lm	500lm	FF3-8272407X-BB
												40°	700lm	500lm	FF3-8274007X-BB
3000K	24°	750lm	550lm	FF3-8302407X-BB											
	40°	750lm	550lm	FF3-8304007X-BB											
4000K	24°	800lm	600lm	FF3-8402407X-BB											
	40°	800lm	600lm	FF3-8404007X-BB											
7 W	9 W	10 V	700 mA	80	2700K							24°	700lm	550lm	FF3-8272407X-WS
												40°	700lm	550lm	FF3-8274007X-WS
						3000K	24°	750lm	600lm	FF3-8302407X-WS					
							40°	750lm	600lm	FF3-8304007X-WS					
						4000K	24°	800lm	650lm	FF3-8402407X-WS					
							40°	800lm	650lm	FF3-8404007X-WS					
						7 W	9 W	10 V	700 mA	80	2700K	24°	700lm	550lm	FF3-8272407X-BS
												40°	700lm	550lm	FF3-8274007X-BS
3000K	24°	750lm	600lm	FF3-8302407X-BS											
	40°	750lm	600lm	FF3-8304007X-BS											
4000K	24°	800lm	650lm	FF3-8402407X-BS											
	40°	800lm	650lm	FF3-8404007X-BS											

Code Remark: X=F(ON-OFF) X=P(Phase Dim) X=A(1-10V Dim) X=D(DALI Dim)

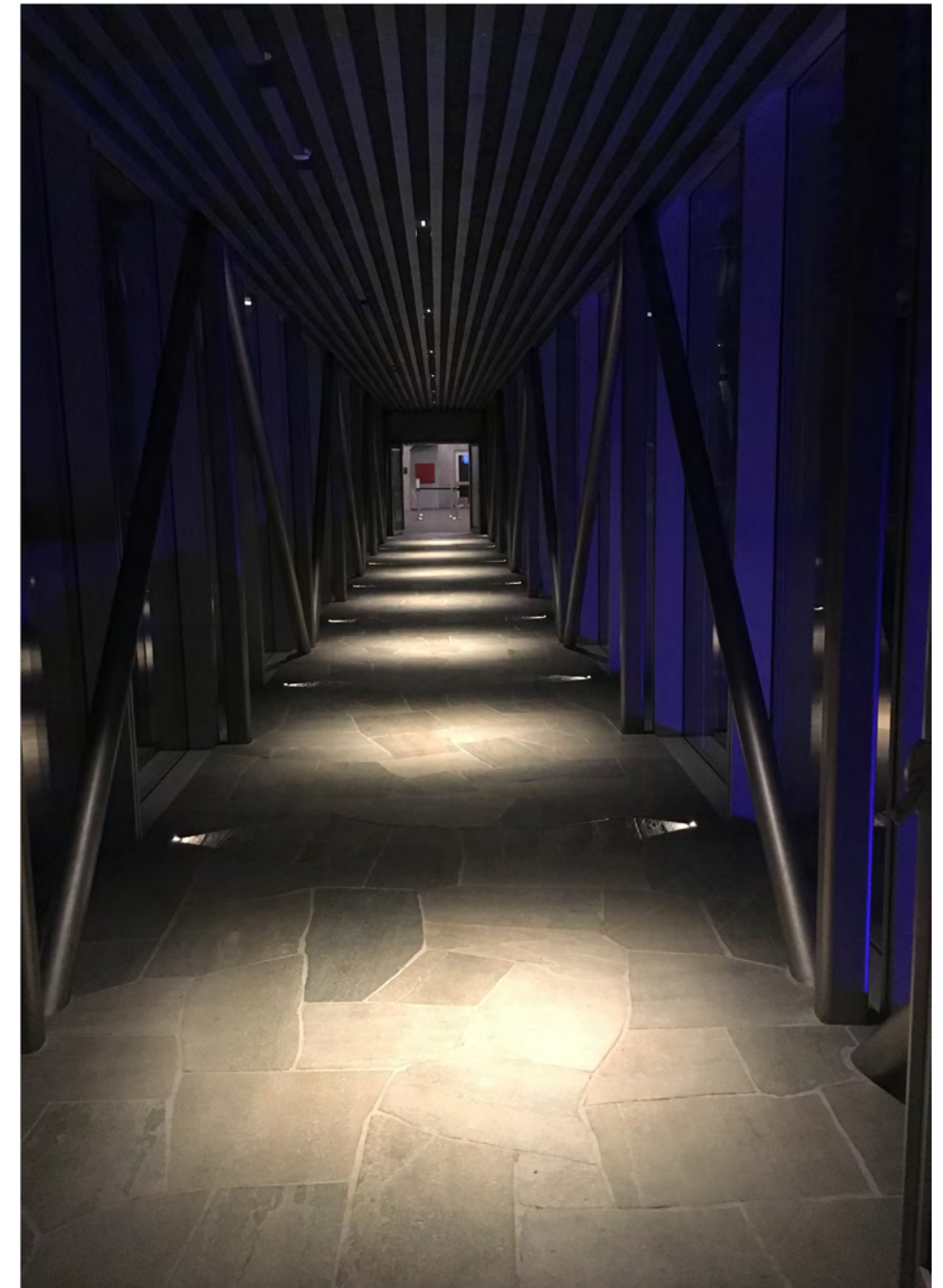

NEKO / FUSION / FF5  
Fixed LED Downlight



11W CRI90 2700K 24° CREE UGR < 10 IP20 5 YEAR GUARANTEE CB CE cUL US LISTED

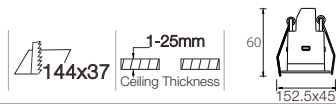

LED Power	System Power	LED Voltage	LED Current	CRI	CCT	Beam	LED Output	System Output	Code						
11 W	13 W	16 V	700 mA	80	2700K	24°	1200lm	850lm	FF5-8272411X-WB						
						40°	1200lm	850lm	FF5-8274011X-WB						
						3000K	24°	1300lm	900lm	FF5-8302411X-WB					
							40°	1300lm	900lm	FF5-8304011X-WB					
						4000K	24°	1400lm	950lm	FF5-8402411X-WB					
							40°	1400lm	950lm	FF5-8404011X-WB					
						11 W	13 W	16 V	700 mA	80	2700K	24°	1200lm	850lm	FF5-8272411X-BB
												40°	1200lm	850lm	FF5-8274011X-BB
3000K	24°	1300lm	900lm	FF5-8302411X-BB											
	40°	1300lm	900lm	FF5-8304011X-BB											
4000K	24°	1400lm	950lm	FF5-8402411X-BB											
	40°	1400lm	950lm	FF5-8404011X-BB											
11 W	13 W	16 V	700 mA	80	2700K							24°	1200lm	950lm	FF5-8272411X-WS
												40°	1200lm	950lm	FF5-8274011X-WS
						3000K	24°	1300lm	1000lm	FF5-8302411X-WS					
							40°	1300lm	1000lm	FF5-8304011X-WS					
						4000K	24°	1400lm	1100lm	FF5-8402411X-WS					
							40°	1400lm	1100lm	FF5-8404011X-WS					
						11 W	13 W	16 V	700 mA	80	2700K	24°	1200lm	950lm	FF5-8272411X-BS
												40°	1200lm	950lm	FF5-8274011X-BS
3000K	24°	1300lm	1000lm	FF5-8302411X-BS											
	40°	1300lm	1000lm	FF5-8304011X-BS											
4000K	24°	1400lm	1100lm	FF5-8402411X-BS											
	40°	1400lm	1100lm	FF5-8404011X-BS											

Code Remark: X=F(ON-OFF) X=P(Phase Dim) X=A(1-10V Dim) X=D(DALI Dim)





NEKO / FUSION / FF10  
Fixed LED Downlight



22W CRI90 2700K 24° CREE UGR < 10 IP20 5 YEAR GUARANTEE CB CE cUL US LISTED

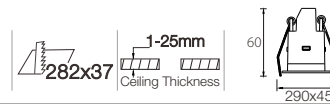

LED Power	System Power	LED Voltage	LED Current	CRI	CCT	Beam	LED Output	System Output	Code						
22 W	24 W	31 V	700 mA	80	2700K	24°	2400lm	1600lm	FF10-8272422X-WB						
						40°	2400lm	1600lm	FF10-8274022X-WB						
						3000K	24°	2600lm	1800lm	FF10-8302422X-WB					
							40°	2600lm	1800lm	FF10-8304022X-WB					
						4000K	24°	2800lm	2000lm	FF10-8402422X-WB					
							40°	2800lm	2000lm	FF10-8404022X-WB					
						22 W	24 W	31 V	700 mA	80	2700K	24°	2400lm	1600lm	FF10-8272422X-BB
												40°	2400lm	1600lm	FF10-8274022X-BB
3000K	24°	2600lm	1800lm	FF10-8302422X-BB											
	40°	2600lm	1800lm	FF10-8304022X-BB											
4000K	24°	2800lm	2000lm	FF10-8402422X-BB											
	40°	2800lm	2000lm	FF10-8404022X-BB											
22 W	24 W	31 V	700 mA	80	2700K							24°	2400lm	2000lm	FF10-8272422X-WS
												40°	2400lm	2000lm	FF10-8274022X-WS
						3000K	24°	2600lm	2100lm	FF10-8302422X-WS					
							40°	2600lm	2100lm	FF10-8304022X-WS					
						4000K	24°	2800lm	2300lm	FF10-8402422X-WS					
							40°	2800lm	2300lm	FF10-8404022X-WS					
						22 W	24 W	31 V	700 mA	80	2700K	24°	2400lm	2000lm	FF10-8272422X-BS
												40°	2400lm	2000lm	FF10-8274022X-BS
3000K	24°	2600lm	2100lm	FF10-8302422X-BS											
	40°	2600lm	2100lm	FF10-8304022X-BS											
4000K	24°	2800lm	2300lm	FF10-8402422X-BS											
	40°	2800lm	2300lm	FF10-8404022X-BS											

Code Remark: X=F(ON-OFF) X=P(Phase Dim) X=A(1-10V Dim) X=D(DALI Dim)

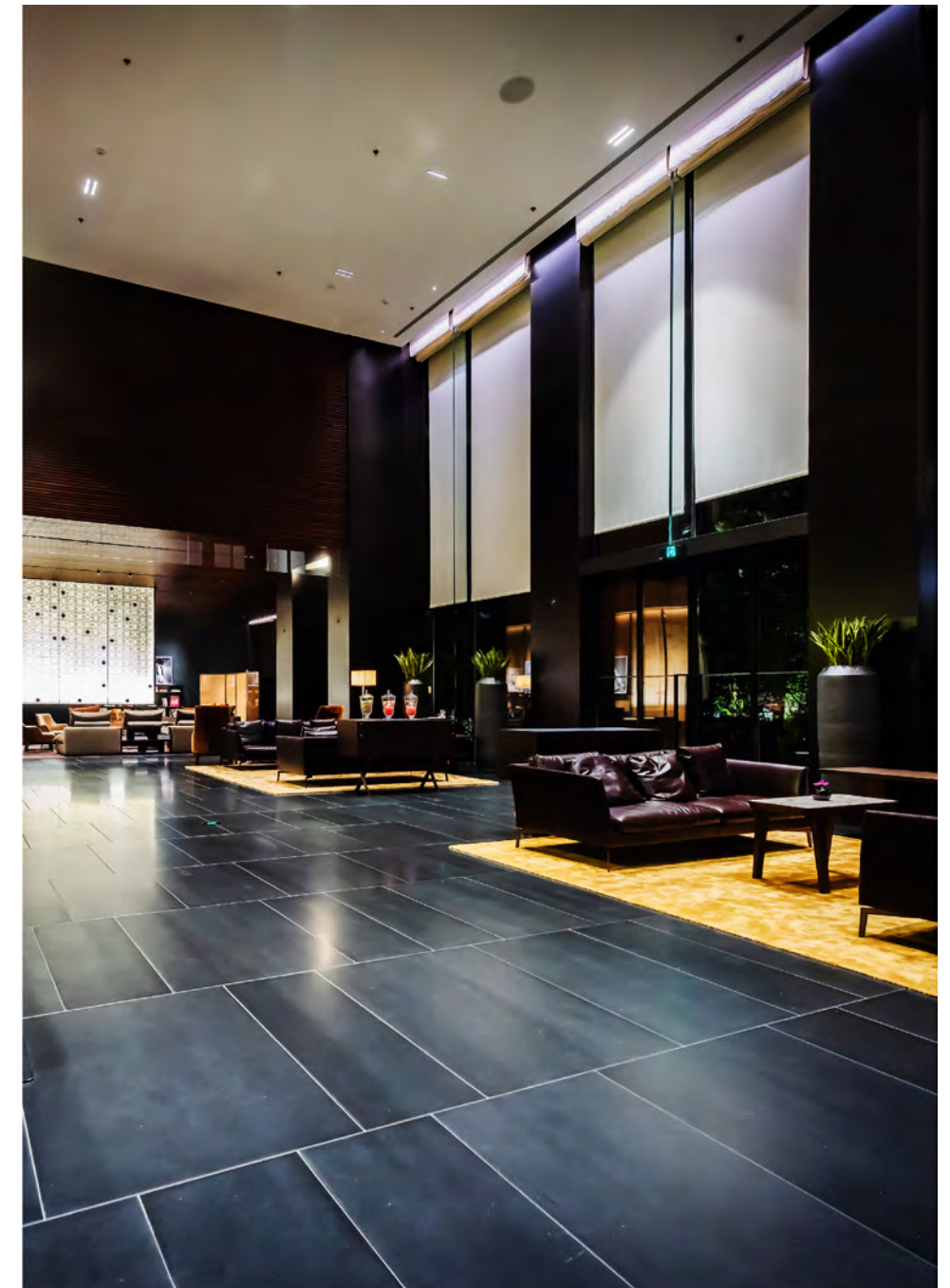





**NEKO / FUSION / FFT5**  
Fixed Trimless Downlight

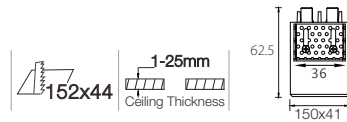

11W CRI90 2700K 24° CREE UGR < 10 IP20 5 YEAR GUARANTEE CB CE UL US LISTED



	LED Power	System Power	LED Voltage	LED Current	CRI	CCT	Beam	LED Output	System Output	Code							
 Black Reflector	11 W	13 W	16 V	700 mA	80	2700K	24°	1200lm	850lm	FFT5-8272411X-WB							
							40°	1200lm	850lm	FFT5-8274011X-WB							
							3000K	24°	1300lm	900lm	FFT5-8302411X-WB						
								40°	1300lm	900lm	FFT5-8304011X-WB						
							4000K	24°	1400lm	950lm	FFT5-8402411X-WB						
								40°	1400lm	950lm	FFT5-8404011X-WB						
							 Black Reflector	11 W	13 W	16 V	700 mA	80	2700K	24°	1200lm	850lm	FFT5-8272411X-BB
														40°	1200lm	850lm	FFT5-8274011X-BB
3000K	24°	1300lm	900lm	FFT5-8302411X-BB													
	40°	1300lm	900lm	FFT5-8304011X-BB													
4000K	24°	1400lm	950lm	FFT5-8402411X-BB													
	40°	1400lm	950lm	FFT5-8404011X-BB													
 Specular Reflector	11 W	13 W	16 V	700 mA	80	2700K								24°	1200lm	950lm	FFT5-8272411X-WS
														40°	1200lm	950lm	FFT5-8274011X-WS
							3000K	24°	1300lm	1000lm	FFT5-8302411X-WS						
								40°	1300lm	1000lm	FFT5-8304011X-WS						
							4000K	24°	1400lm	1100lm	FFT5-8402411X-WS						
								40°	1400lm	1100lm	FFT5-8404011X-WS						
							 Specular Reflector	11 W	13 W	16 V	700 mA	80	2700K	24°	1200lm	950lm	FFT5-8272411X-BS
														40°	1200lm	950lm	FFT5-8274011X-BS
3000K	24°	1300lm	1000lm	FFT5-8302411X-BS													
	40°	1300lm	1000lm	FFT5-8304011X-BS													
4000K	24°	1400lm	1100lm	FFT5-8402411X-BS													
	40°	1400lm	1100lm	FFT5-8404011X-BS													

Code Remark: X=F(ON-OFF) X=P(Phase Dim) X=A(1-10V Dim) X=D(DALI Dim)

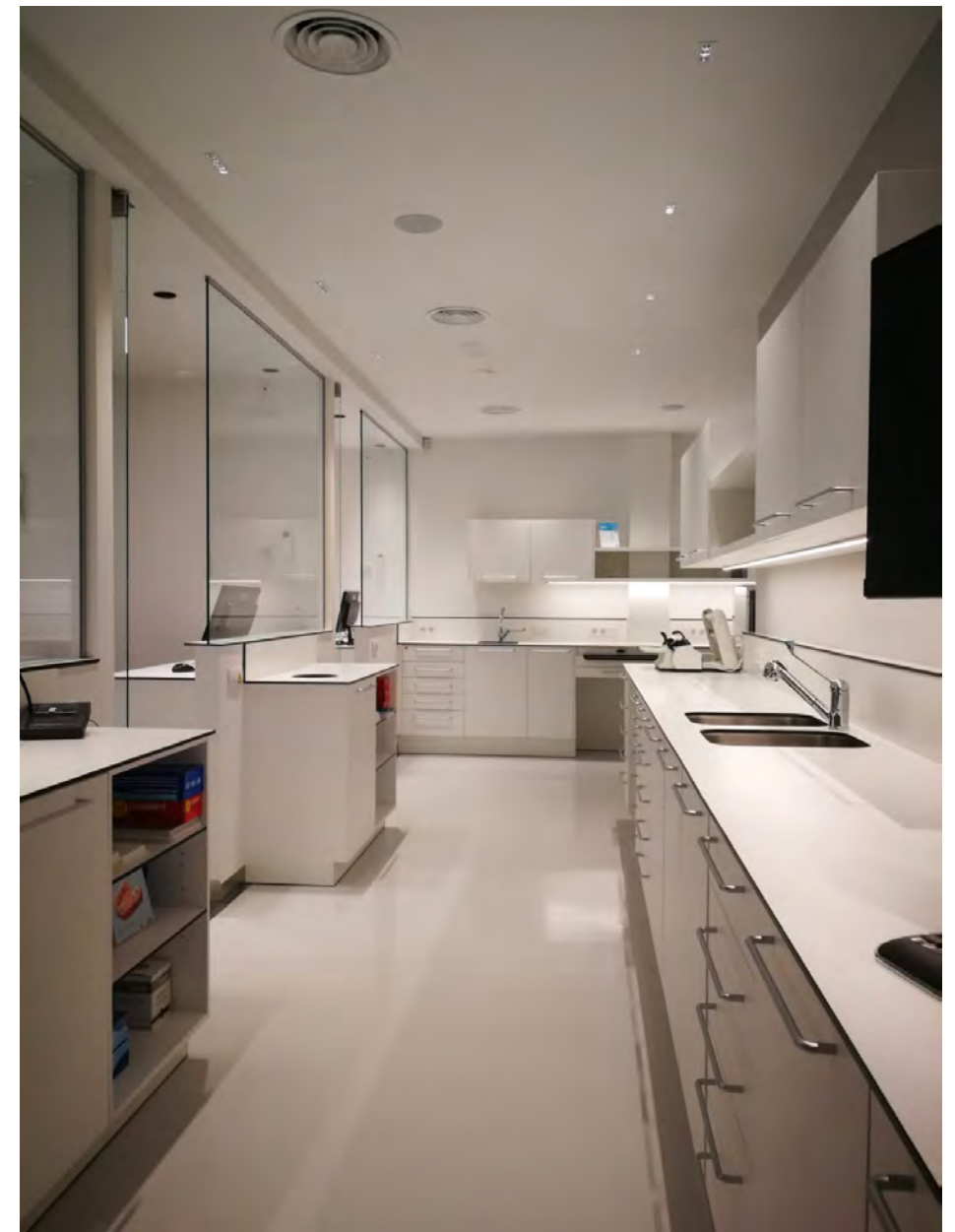







NEKO / FUSION / FFT10  
Fixed Trimless Downlight

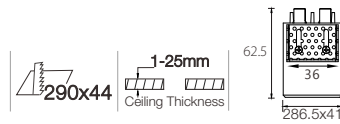

22W CRI90 2700K 24° 3000K 4000K 60,000h@L80B10 CREE UGR < 10 IP20 5 YEAR GUARANTEE CB CE cUL US LISTED



	LED Power	System Power	LED Voltage	LED Current	CRI	CCT	Beam	LED Output	System Output	Code							
 Black Reflector	22 W	24 W	31 V	700 mA	80	2700K	24°	2400lm	1600lm	FFT10-8272422X-WB							
							40°	2400lm	1600lm	FFT10-8274022X-WB							
							3000K	24°	2600lm	1800lm	FFT10-8302422X-WB						
								40°	2600lm	1800lm	FFT10-8304022X-WB						
							4000K	24°	2800lm	2000lm	FFT10-8402422X-WB						
								40°	2800lm	2000lm	FFT10-8404022X-WB						
							 Black Reflector	22 W	24 W	31 V	700 mA	80	2700K	24°	2400lm	1600lm	FFT10-8272422X-BB
														40°	2400lm	1600lm	FFT10-8274022X-BB
3000K	24°	2600lm	1800lm	FFT10-8302422X-BB													
	40°	2600lm	1800lm	FFT10-8304022X-BB													
4000K	24°	2800lm	2000lm	FFT10-8402422X-BB													
	40°	2800lm	2000lm	FFT10-8404022X-BB													
 Specular Reflector	22 W	24 W	31 V	700 mA	80	2700K								24°	2400lm	2000lm	FFT10-8272422X-WS
														40°	2400lm	2000lm	FFT10-8274022X-WS
							3000K	24°	2600lm	2100lm	FFT10-8302422X-WS						
								40°	2600lm	2100lm	FFT10-8304022X-WS						
							4000K	24°	2800lm	2300lm	FFT10-8402422X-WS						
								40°	2800lm	2300lm	FFT10-8404022X-WS						
							 Specular Reflector	22 W	24 W	31 V	700 mA	80	2700K	24°	2400lm	2000lm	FFT10-8272422X-BS
														40°	2400lm	2000lm	FFT10-8274022X-BS
3000K	24°	2600lm	2100lm	FFT10-8302422X-BS													
	40°	2600lm	2100lm	FFT10-8304022X-BS													
4000K	24°	2800lm	2300lm	FFT10-8402422X-BS													
	40°	2800lm	2300lm	FFT10-8404022X-BS													

Code Remark: X=F(ON-OFF) X=P(Phase Dim) X=A(1-10V Dim) X=D(DALI Dim)



**NEKO / FUSION / FA5**  
Adjustable LED Downlight



**NEKO / FUSION**  
Adjustable series LED Downlight



11W CRI90 2700K 24° 3000K 4000K 50,000h@L80B10 CREE UGR < 10 IP20 5 YEAR GUARANTEE CB CE UL LISTED

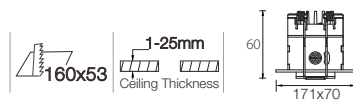

LED Power	System Power	LED Voltage	LED Current	CRI	CCT	Beam	LED Output	System Output	Code						
11 W	13 W	16 V	700 mA	80	2700K	24°	1200lm	850lm	FA5-8272411X-WB						
						40°	1200lm	850lm	FA5-8274011X-WB						
						3000K	24°	1300lm	900lm	FA5-8302411X-WB					
							40°	1300lm	900lm	FA5-8304011X-WB					
						4000K	24°	1400lm	950lm	FA5-8402411X-WB					
							40°	1400lm	950lm	FA5-8404011X-WB					
						11 W	13 W	16 V	700 mA	80	2700K	24°	1200lm	850lm	FA5-8272411X-BB
												40°	1200lm	850lm	FA5-8274011X-BB
3000K	24°	1300lm	900lm	FA5-8302411X-BB											
	40°	1300lm	900lm	FA5-8304011X-BB											
4000K	24°	1400lm	950lm	FA5-8402411X-BB											
	40°	1400lm	950lm	FA5-8404011X-BB											
11 W	13 W	16 V	700 mA	80	2700K							24°	1200lm	950lm	FA5-8272411X-WS
												40°	1200lm	950lm	FA5-8274011X-WS
						3000K	24°	1300lm	1000lm	FA5-8302411X-WS					
							40°	1300lm	1000lm	FA5-8304011X-WS					
						4000K	24°	1400lm	1100lm	FA5-8402411X-WS					
							40°	1400lm	1100lm	FA5-8404011X-WS					
						11 W	13 W	16 V	700 mA	80	2700K	24°	1200lm	950lm	FA5-8272411X-BS
												40°	1200lm	950lm	FA5-8274011X-BS
3000K	24°	1300lm	1000lm	FA5-8302411X-BS											
	40°	1300lm	1000lm	FA5-8304011X-BS											
4000K	24°	1400lm	1100lm	FA5-8402411X-BS											
	40°	1400lm	1100lm	FA5-8404011X-BS											

Code Remark: X=F(ON-OFF) X=P(Phase Dim) X=A(1-10V Dim) X=D(DALI Dim)

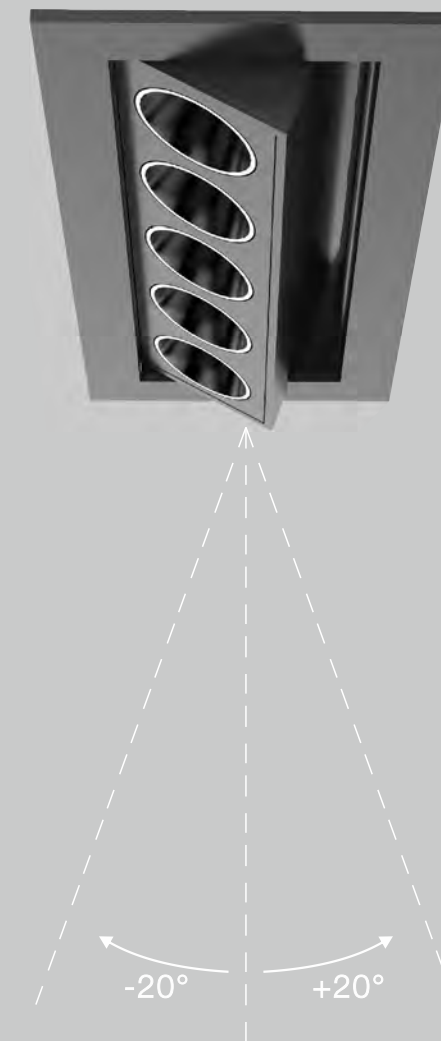



**NEKO / FUSION / FA10**  
Adjustable LED Downlight



22W CRI90 2700K 24° CREE UGR < 10 IP20 5 YEAR GUARANTEE CB CE UL LISTED

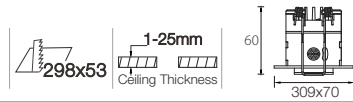

LED Power	System Power	LED Voltage	LED Current	CRI	CCT	Beam	LED Output	System Output	Code						
22 W	24 W	31 V	700 mA	80	2700K	24°	2400lm	1600lm	FA10-8272422X-WB						
						40°	2400lm	1600lm	FA10-8274022X-WB						
						3000K	24°	2600lm	1800lm	FA10-8302422X-WB					
							40°	2600lm	1800lm	FA10-8304022X-WB					
						4000K	24°	2800lm	2000lm	FA10-8402422X-WB					
							40°	2800lm	2000lm	FA10-8404022X-WB					
						22 W	24 W	31 V	700 mA	80	2700K	24°	2400lm	1600lm	FA10-8272422X-BB
												40°	2400lm	1600lm	FA10-8274022X-BB
3000K	24°	2600lm	1800lm	FA10-8302422X-BB											
	40°	2600lm	1800lm	FA10-8304022X-BB											
4000K	24°	2800lm	2000lm	FA10-8402422X-BB											
	40°	2800lm	2000lm	FA10-8404022X-BB											
22 W	24 W	31 V	700 mA	80	2700K							24°	2400lm	2000lm	FA10-8272422X-WS
												40°	2400lm	2000lm	FA10-8274022X-WS
						3000K	24°	2600lm	2100lm	FA10-8302422X-WS					
							40°	2600lm	2100lm	FA10-8304022X-WS					
						4000K	24°	2800lm	2300lm	FA10-8402422X-WS					
							40°	2800lm	2300lm	FA10-8404022X-WS					
						22 W	24 W	31 V	700 mA	80	2700K	24°	2400lm	2000lm	FA10-8272422X-BS
												40°	2400lm	2000lm	FA10-8274022X-BS
3000K	24°	2600lm	2100lm	FA10-8302422X-BS											
	40°	2600lm	2100lm	FA10-8304022X-BS											
4000K	24°	2800lm	2300lm	FA10-8402422X-BS											
	40°	2800lm	2300lm	FA10-8404022X-BS											

Code Remark: X=F(ON-OFF) X=P(Phase Dim) X=A(1-10V Dim) X=D(DALI Dim)

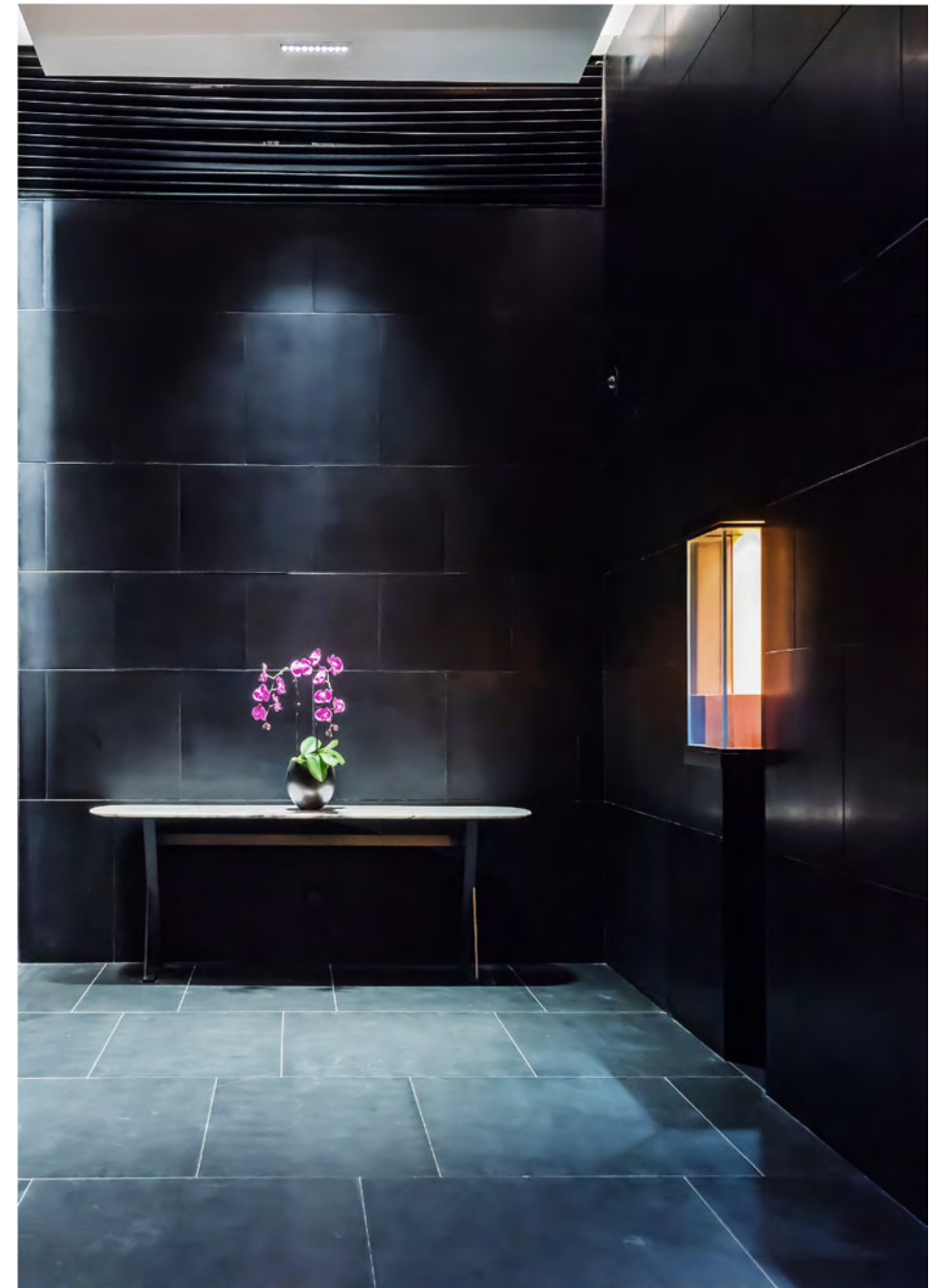

NEKO / FUSION / FW5  
Wall Washer LED Downlight

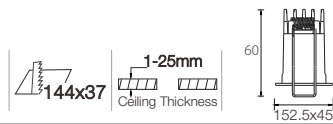

Matt Reflector



Matt Reflector

LED Power	System Power	LED Voltage	LED Current	CRI	CCT	Beam	LED Output	System Output	Code
11 W	13 W	16 V	700 mA	80	2700K	WW	1200lm	550lm	FW5-827WW11X-WM
					3000K	WW	1300lm	600lm	FW5-830WW11X-WM
					4000K	WW	1400lm	650lm	FW5-840WW11X-WM

11 W	13 W	16 V	700 mA	80	2700K	WW	1200lm	550lm	FW5-827WW11X-BM
					3000K	WW	1300lm	600lm	FW5-830WW11X-BM
					4000K	WW	1400lm	650lm	FW5-840WW11X-BM

Code Remark: X=F(ON-OFF) X=P(Phase Dim) X=A(1-10V Dim) X=D(DALI Dim)

Trimless available



Trimless code for FW5-830WW11X-WM  
FWT5-830WW11X-WM

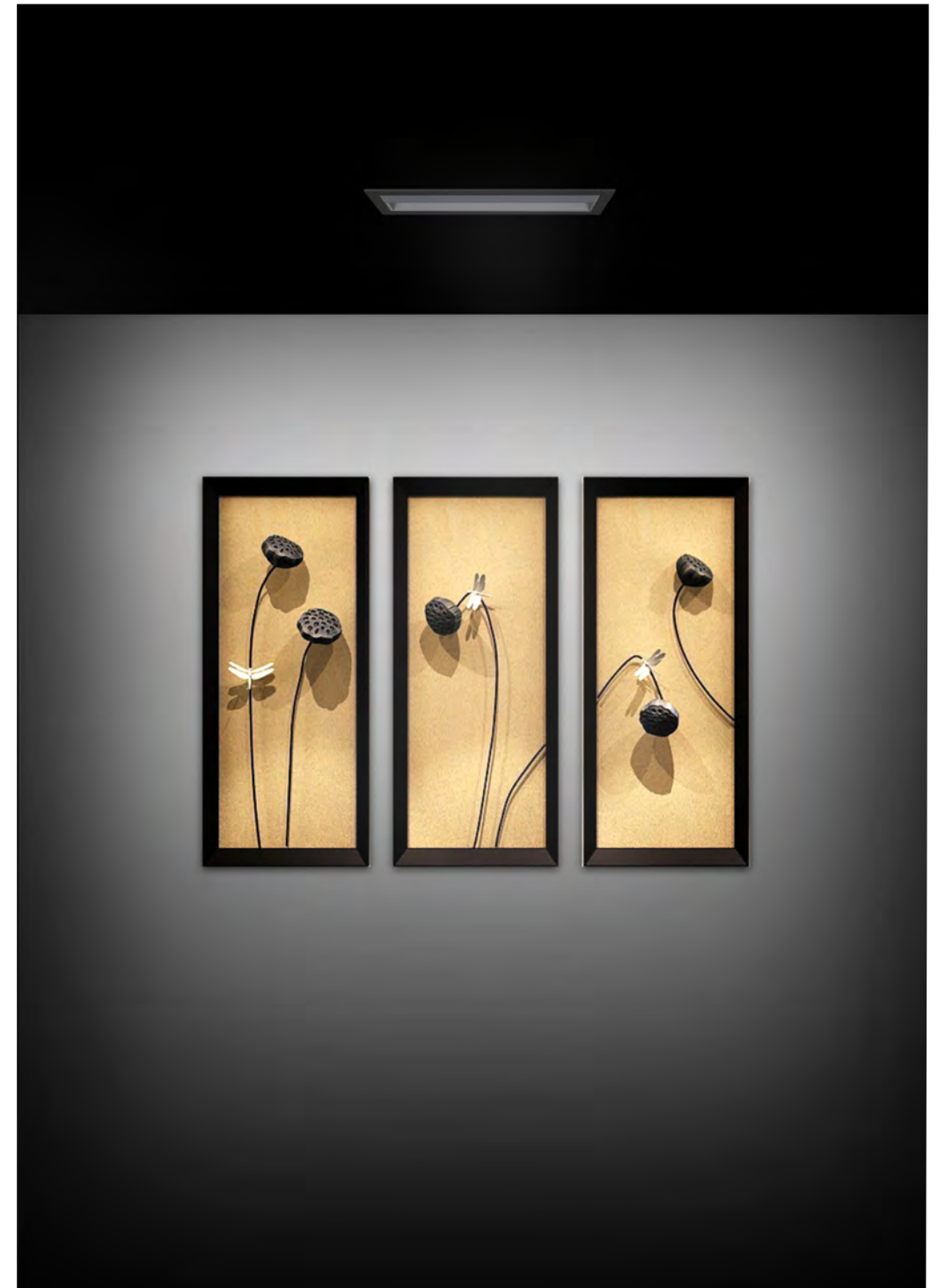
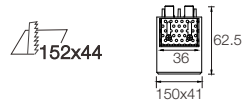



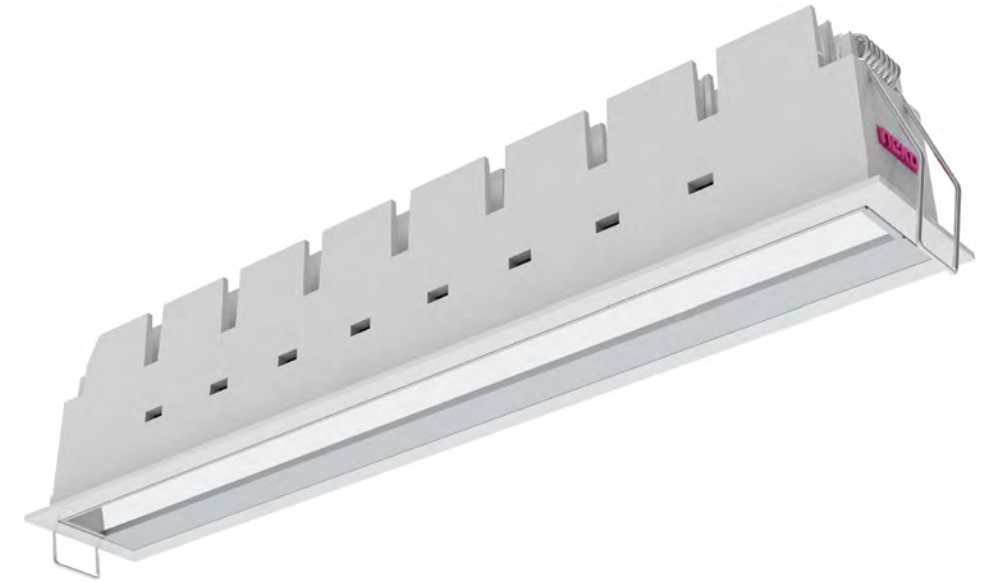

LED Power	System Power	LED Voltage	LED Current	CRI	CCT	Beam	LED Output	System Output	Code
22 W	24 W	31 V	700 mA	80	2700K	WW	2400lm	1100lm	FW10-827WW22X-WM
					3000K	WW	2600lm	1200lm	FW10-830WW22X-WM
					4000K	WW	2800lm	1300lm	FW10-840WW22X-WM
-----									
22 W	24 W	31 V	700 mA	80	2700K	WW	2400lm	1100lm	FW10-827WW22X-BM
					3000K	WW	2600lm	1200lm	FW10-830WW22X-BM
					4000K	WW	2800lm	1300lm	FW10-840WW22X-BM

Code Remark: X=F(ON-OFF) X=P(Phase Dim) X=A(1-10V Dim) X=D(DALI Dim)

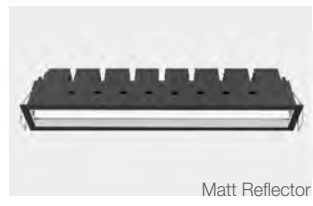

Trimless available

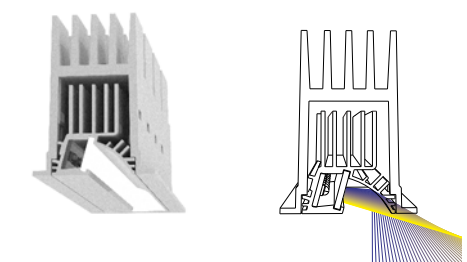
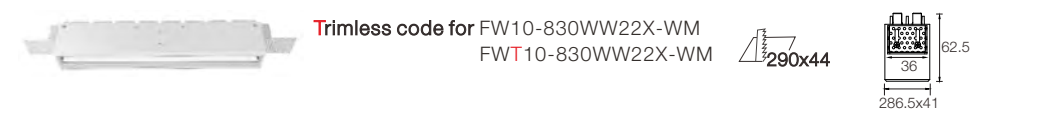

sehr gute Wall Washer Beleuchtungsqualität  
High quality wall washer illumination

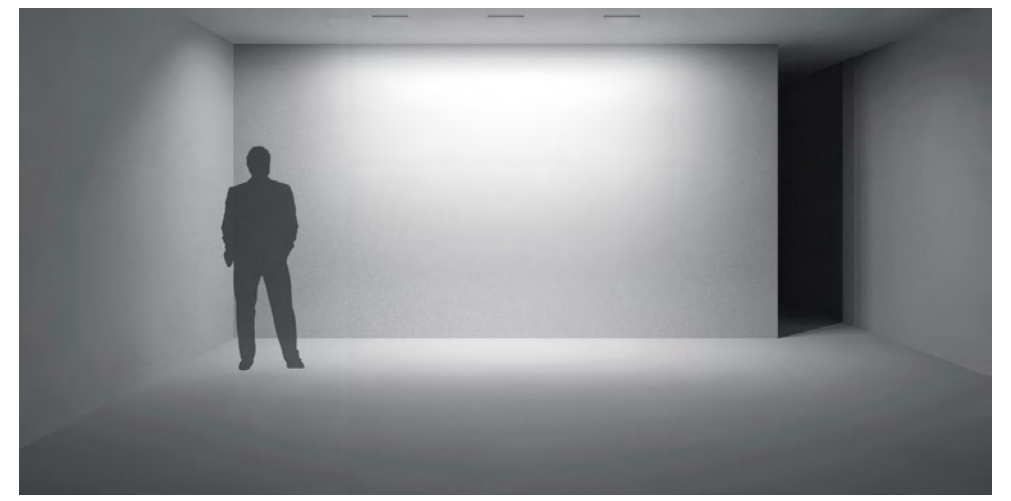

NEKO / FUSION / **FG5**  
General LED Downlight

NEKO / FUSION / **FG10**  
General LED Downlight

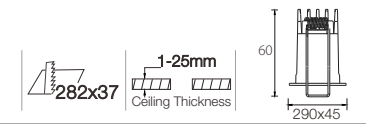
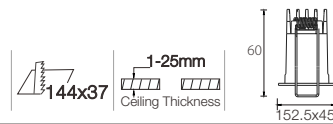
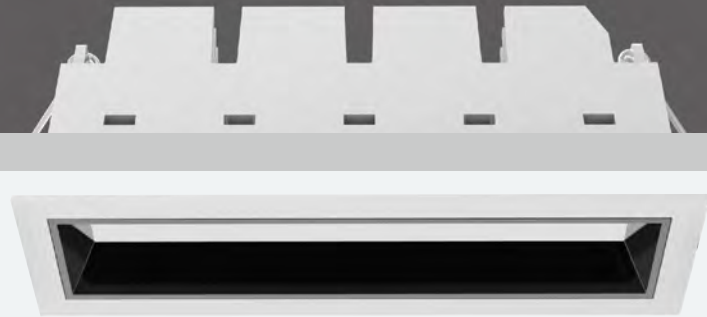

Black Reflector

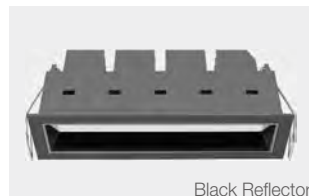

Black Reflector

LED Power	System Power	LED Voltage	LED Current	CRI	CCT	Beam	LED Output	System Output	Code
11 W	13 W	16 V	700 mA	80	2700K	75°	1200lm	380lm	FG5-8277511X-WB
					3000K	75°	1300lm	400lm	FG5-8307511X-WB
					4000K	75°	1400lm	450lm	FG5-8407511X-WB
11 W	13 W	16 V	700 mA	80	2700K	75°	1200lm	350lm	FG5-8277511X-BB
					3000K	75°	1300lm	400lm	FG5-8307511X-BB
					4000K	75°	1400lm	450lm	FG5-8407511X-BB

Code Remark: X=F(ON-OFF) X=P(Phase Dim) X=A(1-10V Dim) X=D(DALI Dim)

Trimless available



Trimless code for FG5-8307511X-WB  
FGT5-8307511X-WB

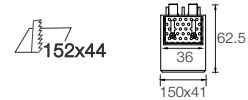

Black Reflector

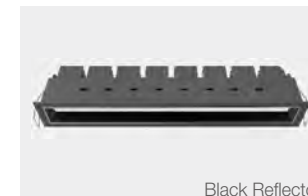

Black Reflector

LED Power	System Power	LED Voltage	LED Current	CRI	CCT	Beam	LED Output	System Output	Code
22 W	24 W	31 V	700 mA	80	2700K	75°	2400lm	850lm	FG10-8277522X-WB
					3000K	75°	2600lm	900lm	FG10-8307522X-WB
					4000K	75°	2800lm	950lm	FG10-8407522X-WB
22 W	24 W	31 V	700 mA	80	2700K	75°	2400lm	850lm	FG10-8277522X-BB
					3000K	75°	2600lm	900lm	FG10-8307522X-BB
					4000K	75°	2800lm	950lm	FG10-8407522X-BB

Code Remark: X=F(ON-OFF) X=P(Phase Dim) X=A(1-10V Dim) X=D(DALI Dim)

Trimless available



Trimless code for FG10-8307522X-WB  
FGT10-8307522X-WB

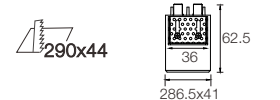



**NEKO / FUSION Linear System**  
With FUSION Downlight Module

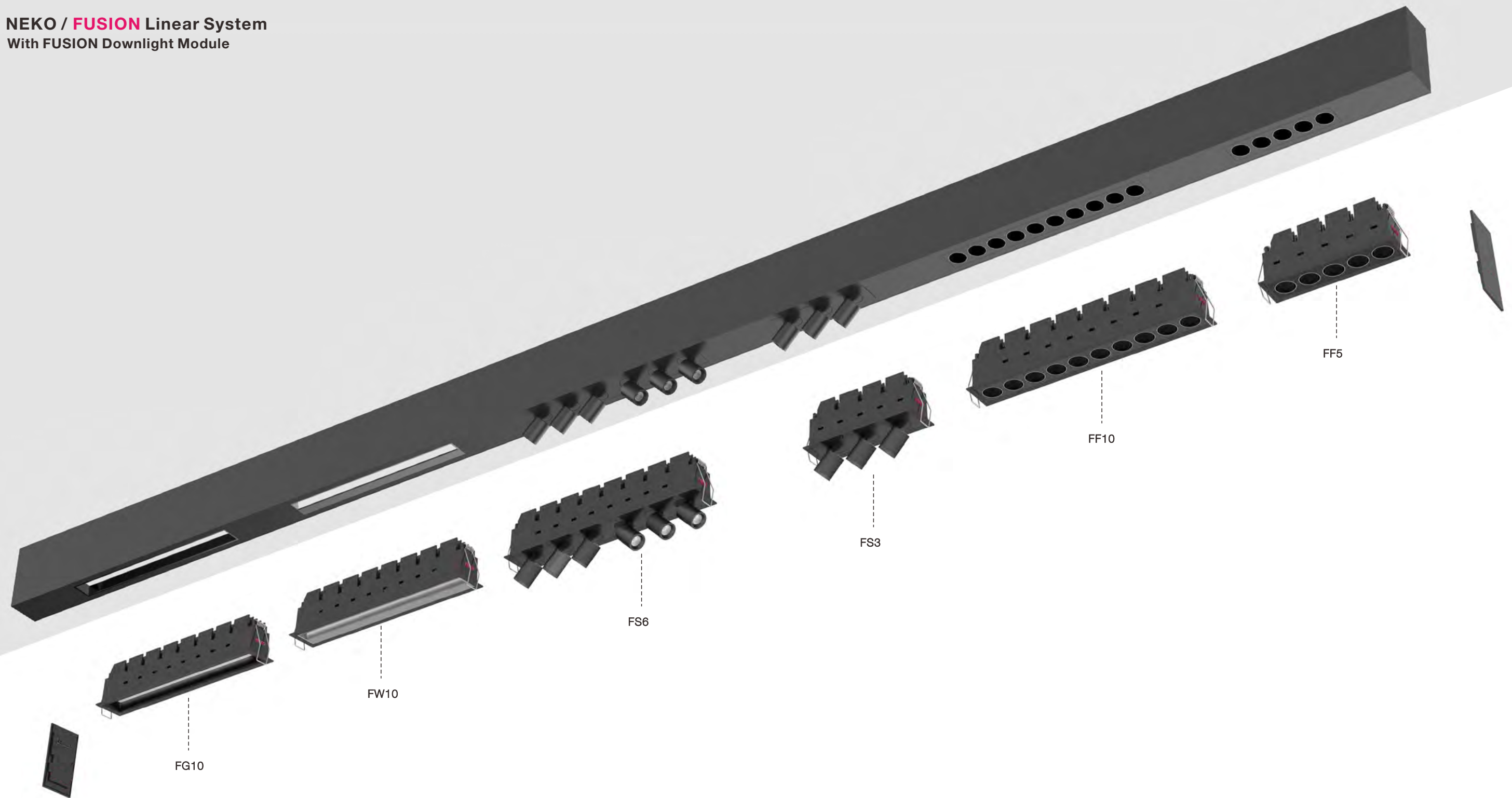

- Aufbau-, Einbau- und Pendelleuchte.
- Einfache und unbegrenzte Längenbestimmung, nahtlose Verbindung.
- Das Profil kann als einzelne, allgemeine, wall washer oder mit verschiedenen und unterschiedlichen Modulen bestückt werden.
- Modulares Profildesign ohne sichtbare Schrauben, Standardlänge 1,2 m & 1,5 m.
- Aluminiumprofil, Farbwahl weiß / schwarz / natur eloxiertes Aluminium.
- Pendelleuchte mit 2000mm Seilabhängung, werkzeuglose Höhenverstellung.
- Höher Sehkomfort, UGR <19.
- LED 3000K / 4000K, Binning <3 step MacAdam, CRI 80/90.

- Suspended, surface mounted and recessed mounted luminaires.
- Easy and unlimited length adjustment, seamless connection.
- Can be used as single fixed / general light / spotlight / wall washer / MIXED.
- Modular profile design with no visible screws, standard length 1.2m & 1.5m.
- Aluminum profile, color choices white / black / natural anodized aluminum.
- Suspended luminaire with 2000mm cable suspension, tool free height adjustment.
- High visual comfort, UGR<19.
- LED 3000K/ 4000K, binning≤ 3 step MacAdam, CRI 80/ 90.

**NEKO / FUSION Linear System**  
With Linear Light Module

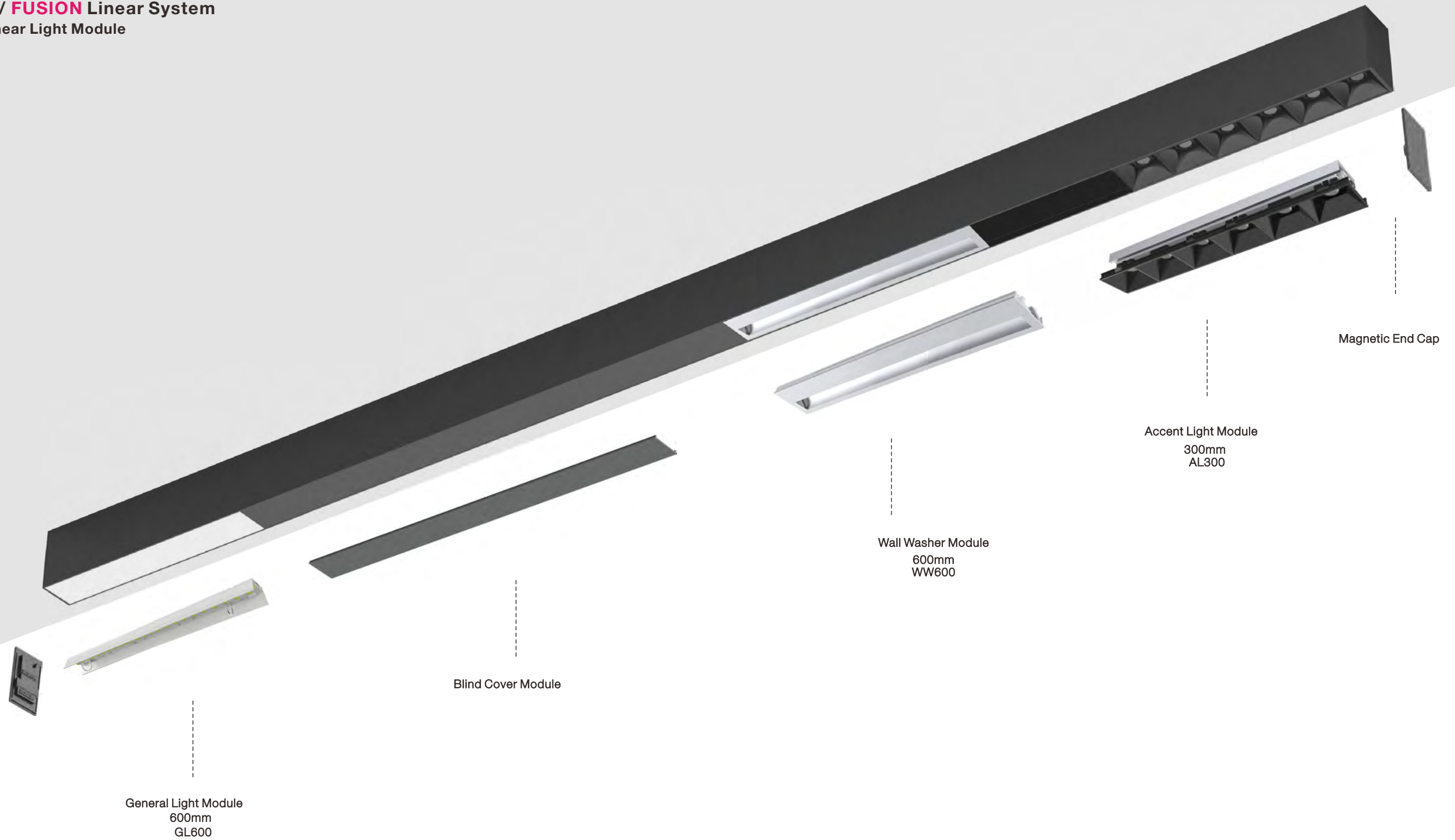

- Schönes Profilsystem aus Aluminiumdruckguss und mit 50 mm Breite
- Verschiedenste Lichtmodule für beste und individuelle Lichtlösungen
- Akzent-, Allgemein- und Spotbeleuchtung – auch Wall washer Modul vorhanden
- Komplett werkzeuglose Montage
- Standard und kundenspezifische Längen
- Magnetische Endkappen – keine Schrauben sichtbar

- Profile system made of extruded aluminium with 50mm width.
- Various lighting modules with multiple lighting applications.
- General light, accent light, wall washer and spotlight module for choice.
- Tool-free inserts mounting by clip-in mechanism.
- Standard and customized length of module and cover for high precise system.
- Magnetic end cap without fixing screws.



Corner Modules and Linear Connector

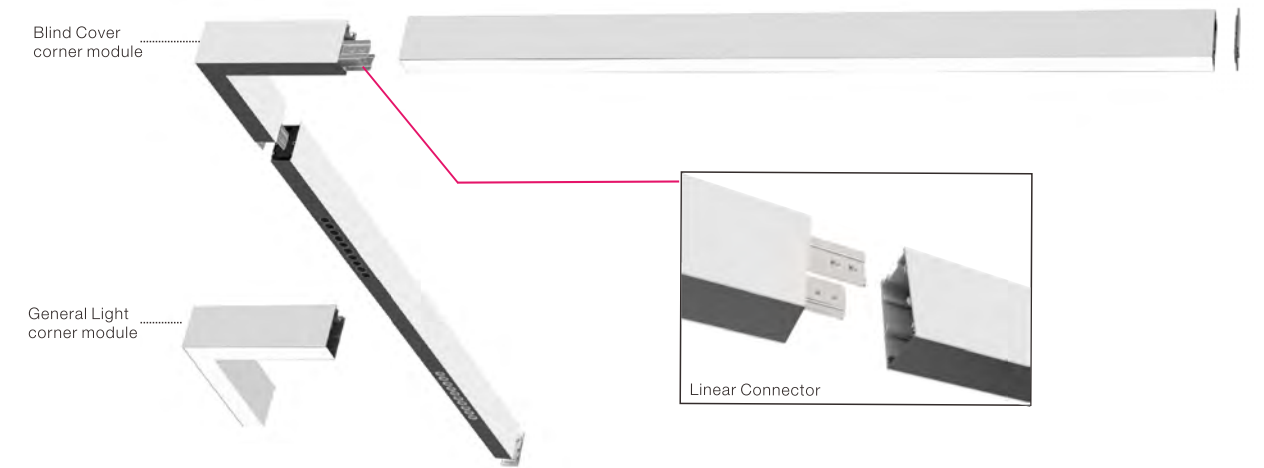

Inserts



System details

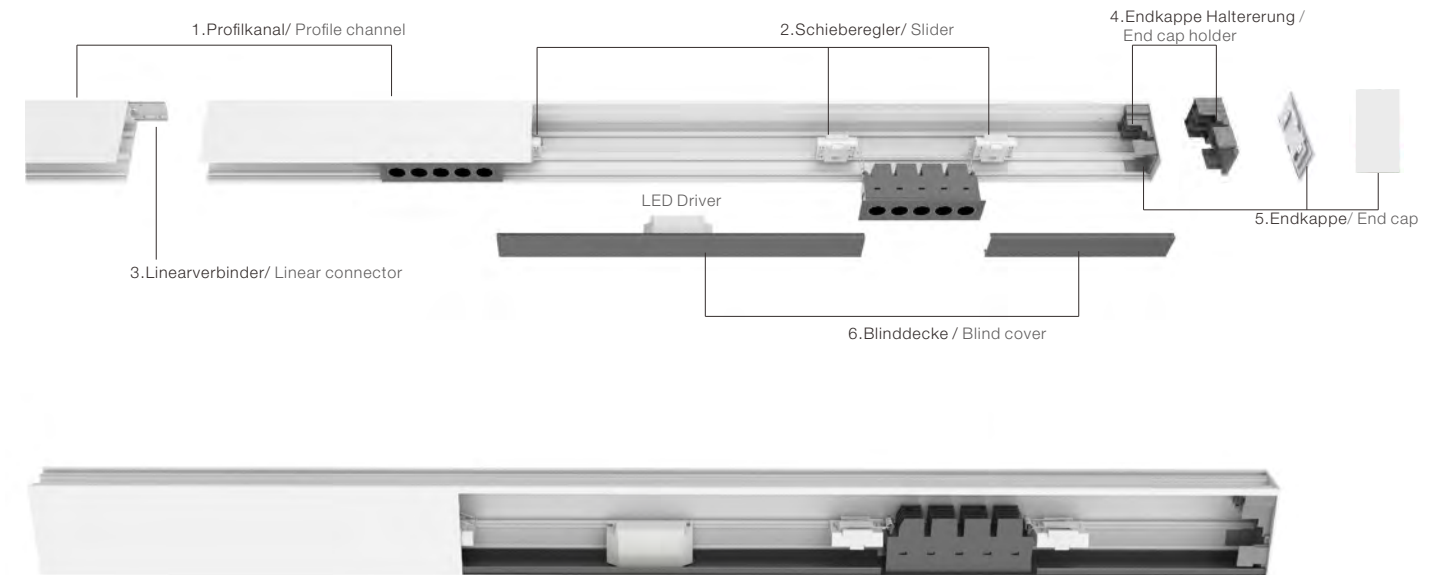

Covers



Intelligentes Linear-Profil-Design  
Einfachste Installation der Fusion-Einbauleuchte in den Profilkanal

Smart linear profile design  
Easy to install fusion downlight into profile channel



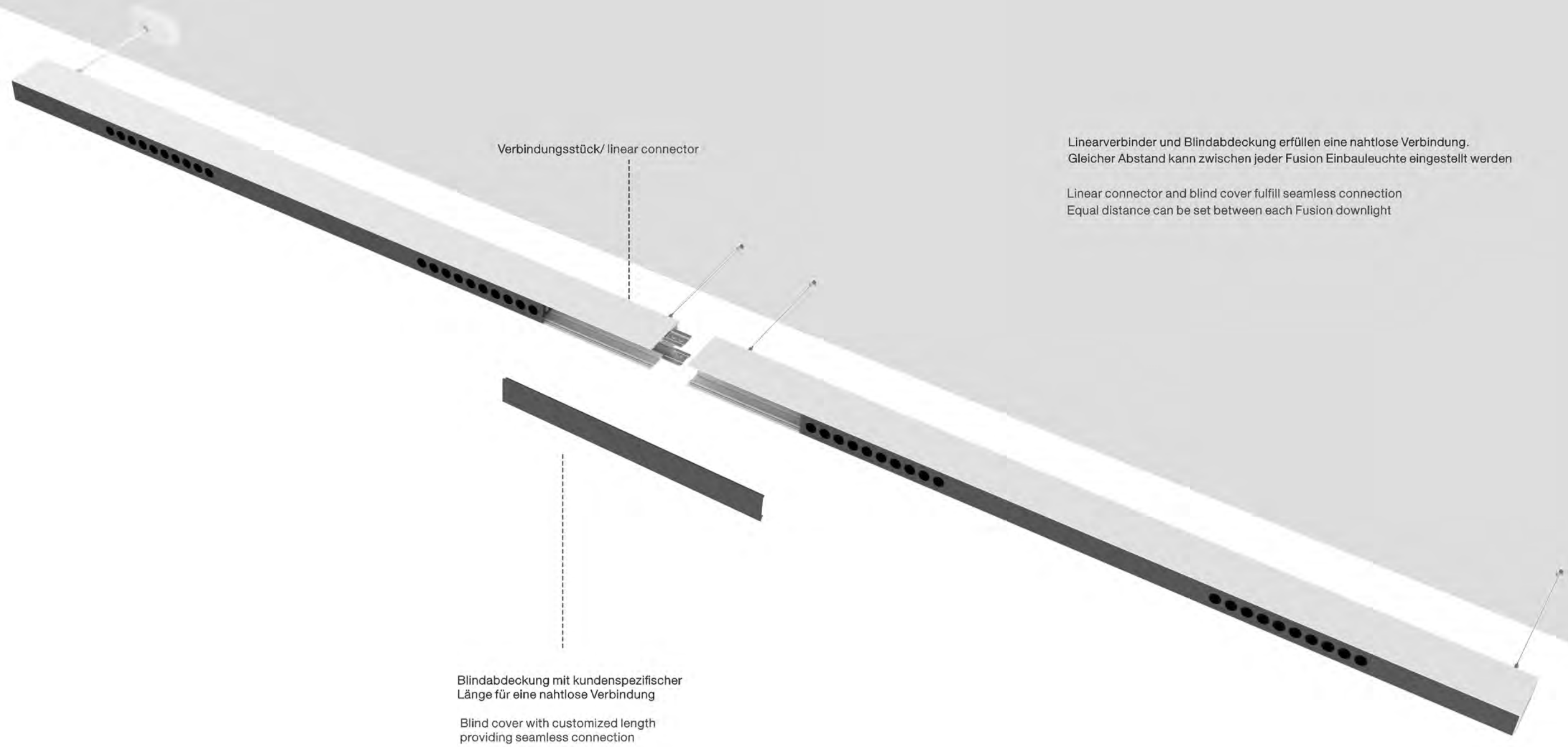

# NEKO / FUSION Linear System

## Linear Light module

### General Light Module



**GL600**  
Linkable extruded aluminium  
for continuous linear light  
594mm for different system  
Opal cover can be customized length

# NEKO / FUSION Linear System

## Linear Light module

### Wallwasher Module



**WW600**  
Uniform wall washer effect  
600mm for different system



LED Power	System Power	LED Voltage	LED Current	CRI	CCT	Beam	LED Output	System Output	Model						
11 W	13 W	46V	250 mA	80	2700K	105°	1600lm	1200lm	GL600-11W-827-105D						
						105°	1700lm	1300lm	GL600-11W-830-105D						
						105°	1800lm	1400lm	GL600-11W-840-105D						
						90	2700K	105°	1500lm	1100lm	GL600-11W-827-105D				
							3000K	105°	1600lm	1200lm	GL600-11W-830-105D				
							4000K	105°	1700lm	1300lm	GL600-11W-840-105D				
						16 W	18 W	46V	350 mA	80	2700K	105°	2100lm	1700lm	GL600-16W-827-105D
												105°	2200lm	1800lm	GL600-16W-830-105D
												105°	2400lm	1900lm	GL600-16W-840-105D
90	2700K	105°	1900lm	1600lm	GL600-16W-827-105D										
	3000K	105°	2000lm	1700lm	GL600-16W-830-105D										
	4000K	105°	2200lm	1900lm	GL600-16W-840-105D										

Code Remark: X=F(ON-OFF) X=P(Phase Dim) X=A(1-10V Dim) X=D(DALI Dim)

### Light Distribution

3000K

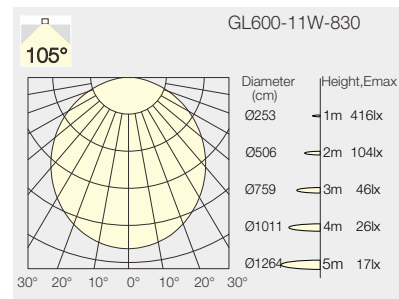

For more info see: [www.nekolighting.com](http://www.nekolighting.com)



LED Power	System Power	LED Voltage	LED Current	CRI	CCT	Beam	LED Output	System Output	Model						
11 W	13 W	46V	250 mA	80	2700K	WW	1600lm	850lm	WW600-11W-827						
						WW	1700lm	900lm	WW600-11W-830						
						WW	1800lm	950lm	WW600-11W-840						
						90	2700K	WW	1500lm	750lm	WW600-11W-827				
							3000K	WW	1600lm	800lm	WW600-11W-830				
							4000K	WW	1700lm	900lm	WW600-11W-840				
						16 W	18 W	46V	350 mA	80	2700K	WW	2000lm	1100lm	WW600-16W-827
												WW	2100lm	1200lm	WW600-16W-830
												WW	2300lm	1300lm	WW600-16W-840
90	2700K	WW	1800lm	1000lm	WW600-16W-827										
	3000K	WW	1900lm	1100lm	WW600-16W-830										
	4000K	WW	2100lm	1200lm	WW600-16W-840										

Code Remark: X=F(ON-OFF) X=P(Phase Dim) X=A(1-10V Dim) X=D(DALI Dim)

### Light Distribution

3000K

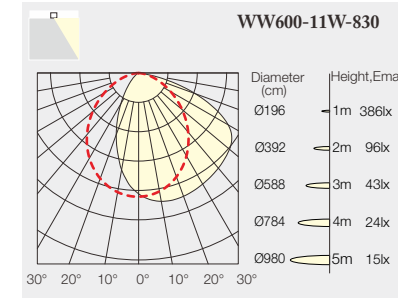

For more info see: [www.nekolighting.com](http://www.nekolighting.com)

# NEKO / FUSION Linear System

Linear Light module

Spot Light Module

SL300-2S-8W



8W CRI80 2700K CRI90 3000K 4000K 12° 24° 30° CREE 50,000h@L80B10 UGR < 19 IP40 5 YEAR GUARANTEE CB CE 73 45 300

LED Power	System Power	LED Voltage	LED Current	CRI	CCT	Beam	LED Output	System Output	Model
8 W	10 W	24V	350 mA	80	2700K	12°	850lm	650lm	SL300-2S-8W-827-12D
						24°	850lm	650lm	SL300-2S-8W-827-24D
						30°	850lm	650lm	SL300-2S-8W-827-30D
						12°	900lm	700lm	SL300-2S-8W-830-12D
						24°	900lm	700lm	SL300-2S-8W-830-24D
						30°	900lm	700lm	SL300-2S-8W-830-30D
					4000K	12°	950lm	750lm	SL300-2S-8W-840-12D
						24°	950lm	750lm	SL300-2S-8W-840-24D
						30°	950lm	750lm	SL300-3S-8W-840-30D

Code Remark: X=F(ON-OFF) X=P(Phase Dim) X=A(1-10V Dim) X=D(DALI Dim)

## Light Distribution

3000K

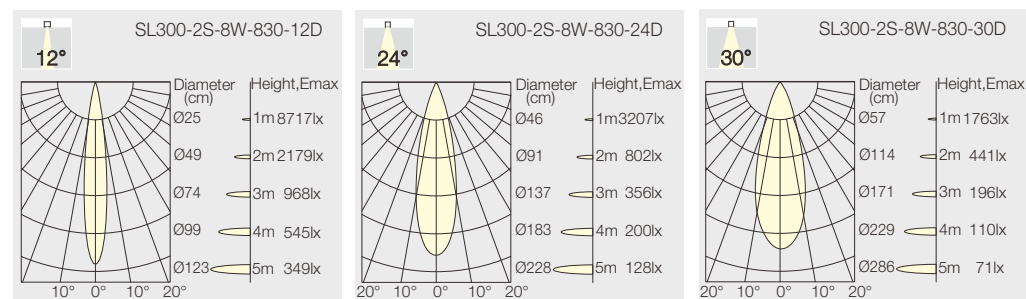

For more info see: [www.nekolighting.com](http://www.nekolighting.com)





## NEKO / FUSION Linear System

Linear Light module

Accent Light Module

AL300-13W



AL300  
Different lens for beam control  
Low glare contributed by black baffle

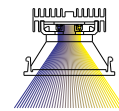

LED Power	System Power	LED Voltage	LED Current	CRI	CCT	Beam	LED Output	System Output	Model	
13 W	15 W	18 V	700 mA	80	2700K	15°	1300lm	1000lm	AL300-26W-827-15D	
						30°	1300lm	1000lm	AL300-26W-827-30D	
						3000K	15°	1400lm	1100lm	AL300-26W-830-15D
							30°	1400lm	1100lm	AL300-26W-830-30D
						4000K	15°	1500lm	1200lm	AL300-26W-840-15D
							30°	1500lm	1200lm	AL300-26W-840-30D

Code Remark: X=F(ON-OFF) X=P(Phase Dim) X=A(1-10V Dim) X=D(DALI Dim)

### Light Distribution

3000K

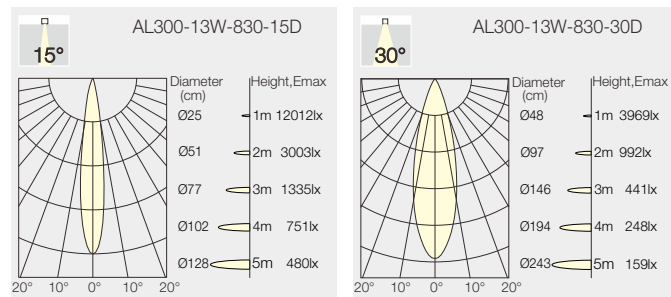

For more info see: [www.nekolighting.com](http://www.nekolighting.com)

## NEKO / FUSION Linear System

Linear Light module

Up Light Module

UL1200-11W/ UL1800-16W



Up Light



LED Power	System Power	LED Voltage	LED Current	CRI	CCT	Beam	LED Output	System Output	Model
11 W	13 W	46 V	250 mA	80	2700K	110°	1700lm	1500lm	UL1200-11W-827-110D
						3000K	1800lm	1600lm	UL1200-11W-830-110D
						4000K	1900lm	1700lm	UL1200-11W-840-110D
16 W	18 W	46 V	350 mA	80	2700K	110°	2300lm	2000lm	UL1800-16W-827-110D
						3000K	2500lm	2200lm	UL1800-16W-830-110D
						4000K	2700lm	2400lm	UL1800-16W-840-110D

Code Remark: X=F(ON-OFF) X=P(Phase Dim) X=A(1-10V Dim) X=D(DALI Dim)

### Light Distribution

3000K

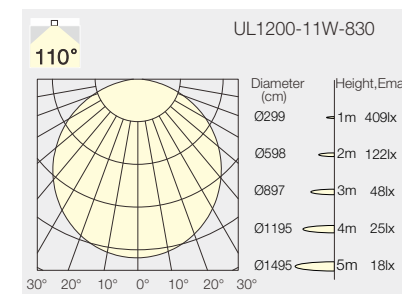

For more info see: [www.nekolighting.com](http://www.nekolighting.com)



Available mounting type

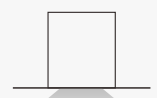

Recessed

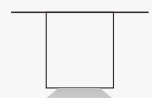

Surface Mounted

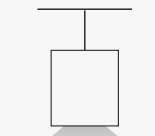

Pendant

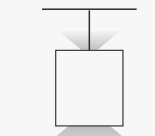

Pendant with Uplight









**NEKO/FUSION Linear System**  
 FL1500-2\*FF10/ FL1200-2\*FF5



44W CRI80 2700K  
 22W CRI90 3000K  
 4000K



CREE  
 50,000h@L80B10

UGR < 10

IP20



CB CE

LED Power	System Power	LED Voltage	LED Current	CRI	CCT	Beam	LED Output	System Output	Length	Model	
44 W	48 W	31+31V	700 mA	80	2700K	24°	5000lm	3400lm	1500mm	FL1500(X)-2*FF10-44W-827-24D	
						40°	5000lm	3400lm	1500mm	FL1500(X)-2*FF10-44W-827-40D	
						3000K	24°	5200lm	3600lm	1500mm	FL1500(X)-2*FF10-44W-830-24D
							40°	5200lm	3600lm	1500mm	FL1500(X)-2*FF10-44W-830-40D
						4000K	24°	5600lm	3800lm	1500mm	FL1500(X)-2*FF10-44W-840-24D
							40°	5600lm	3800lm	1500mm	FL1500(X)-2*FF10-44W-840-40D
22 W	26 W	16+16V	700 mA	80	2700K	24°	2400lm	1700lm	1200mm	FL1200(X)-2*FF5-22W-827-24D	
						40°	2400lm	1700lm	1200mm	FL1200(X)-2*FF5-22W-827-40D	
						3000K	24°	2600lm	1800lm	1200mm	FL1200(X)-2*FF5-22W-830-24D
							40°	2600lm	1800lm	1200mm	FL1200(X)-2*FF5-22W-830-40D
						4000K	24°	2800lm	1900lm	1200mm	FL1200(X)-2*FF5-22W-840-24D
							40°	2800lm	1900lm	1200mm	FL1200(X)-2*FF5-22W-840-40D

Remark: X= P (Pendant) X= S (Surface mounted) X= R (Recessed mounted)

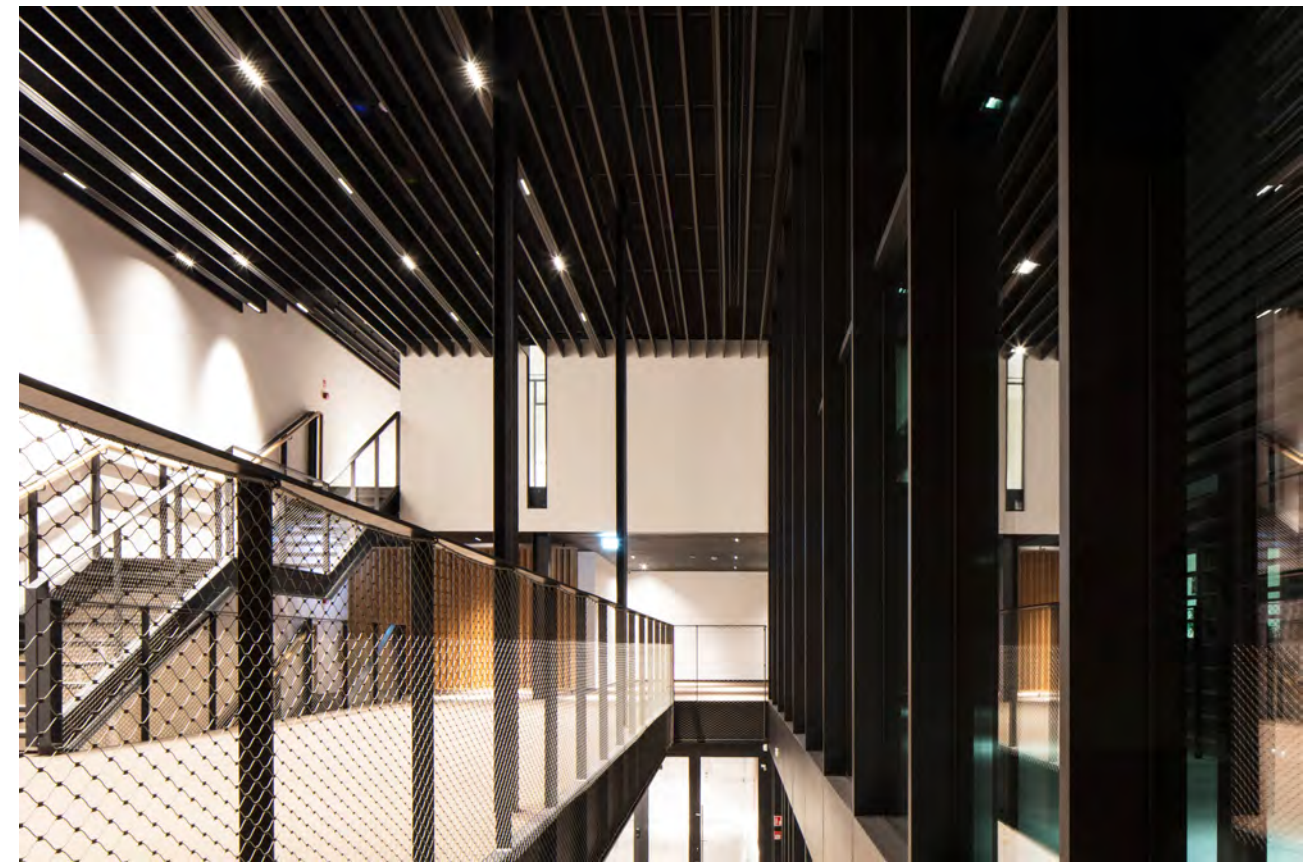



**NEKO/FUSION Linear System**  
**FL1800-GL1800/ FL1200-GL1200**

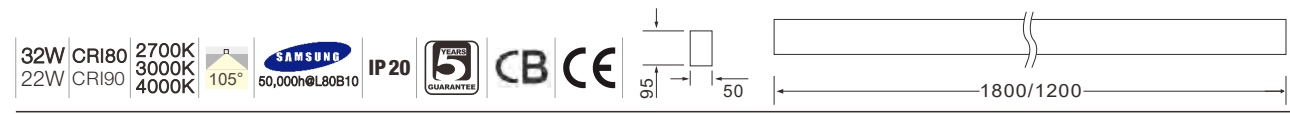
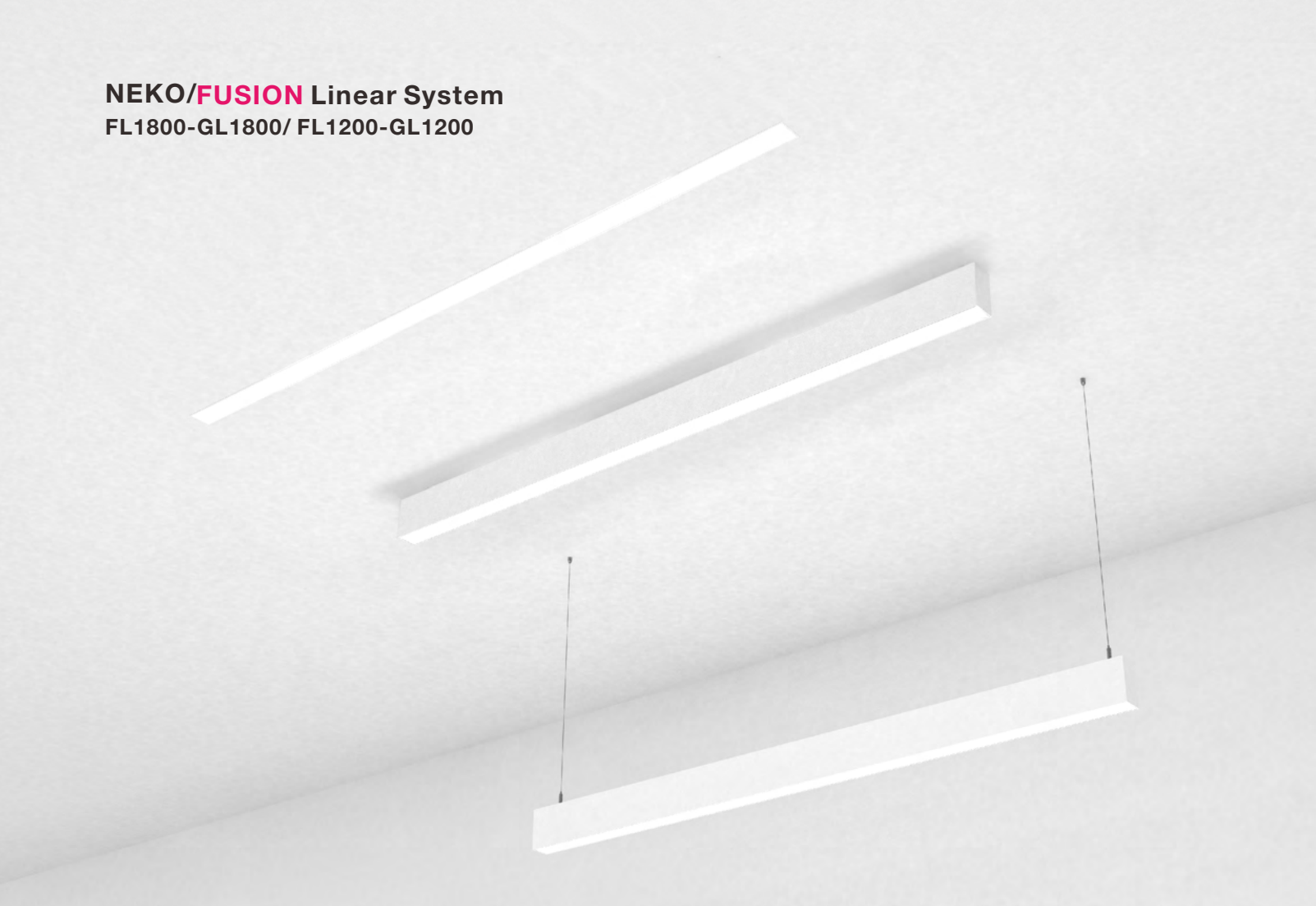

LED Power	System Power	LED Voltage	LED Current	CRI	CCT	Beam	LED Output	System Output	Length	Model
32 W	36 W	46V	700 mA	80	2700K	105°	4600lm	3400lm	1800mm	FL1800(X)-GL1800-32W-827
							3000K 105° 4800lm	3600lm	1800mm	FL1800(X)-GL1800-32W-830
							4000K 105° 5000lm	3800lm	1800mm	FL1800(X)-GL1800-32W-840
48 W	52 W	46V	700+350 mA	80	2700K	105°	6200lm	5000lm	1800mm	FL1800(X)-GL1800-48W-827
							3000K 105° 6400lm	5200lm	1800mm	FL1800(X)-GL1800-48W-830
							4000K 105° 6600lm	5400lm	1800mm	FL1800(X)-GL1800-48W-840
22 W	26 W	46V	500 mA	80	2700K	105°	3200lm	2200lm	1200mm	FL1200(X)-GL1200-22W-827
							3000K 105° 3400lm	2400lm	1200mm	FL1200(X)-GL1200-22W-830
							4000K 105° 3600lm	2600lm	1200mm	FL1200(X)-GL1200-22W-840
32 W	36 W	46V	700 mA	80	2700K	105°	4600lm	3400lm	1200mm	FL1200(X)-GL1200-32W-827
							3000K 105° 4800lm	3600lm	1200mm	FL1200(X)-GL1200-32W-830
							4000K 105° 5000lm	3800lm	1200mm	FL1200(X)-GL1200-32W-840

Remark: X= P (Pendant) X= S (Surface mounted) X= R (Recessed mounted)

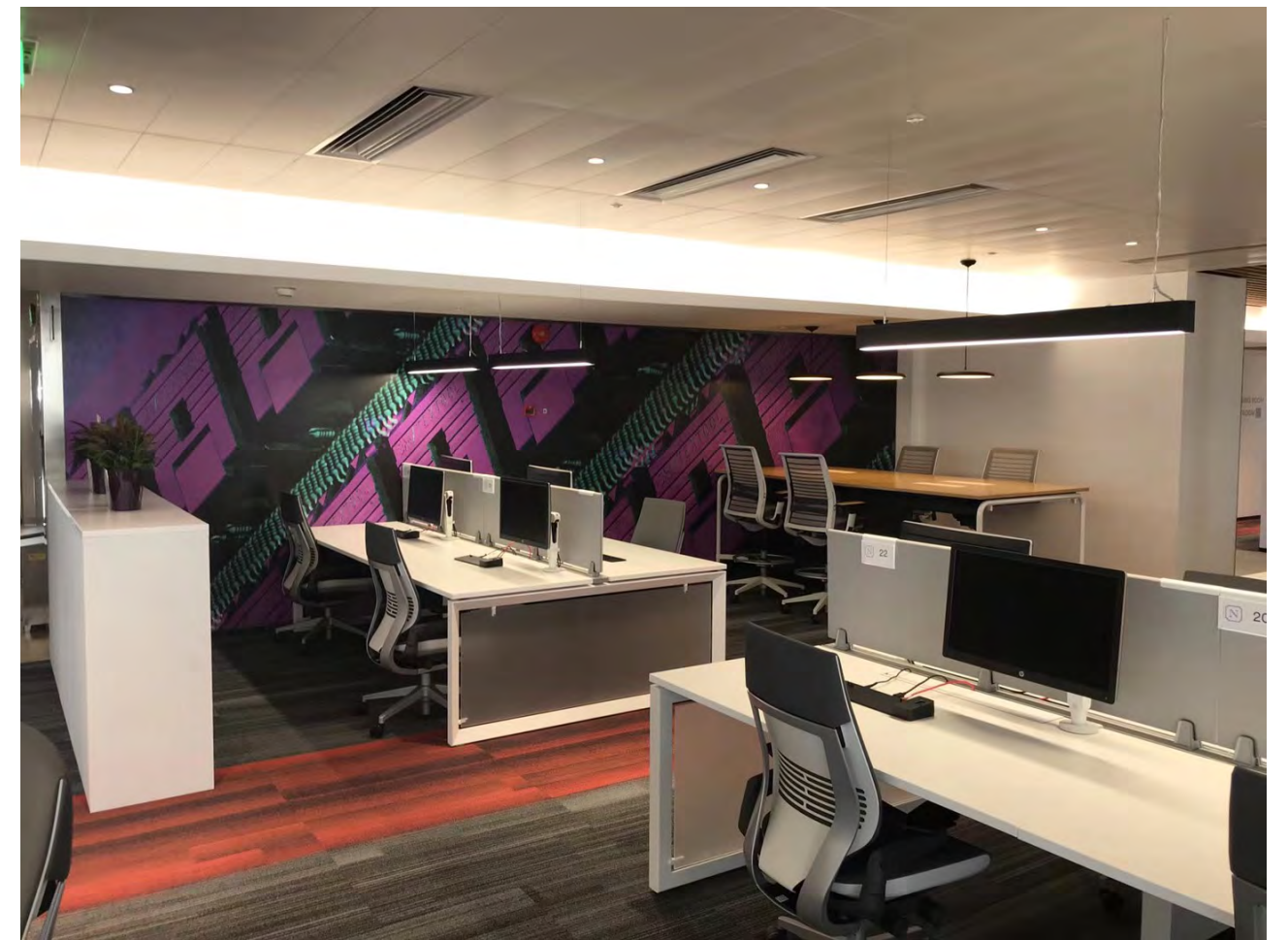



**NEKO/FUSION Linear System**  
**FL1800-WW1800/ FL1200-WW1200**

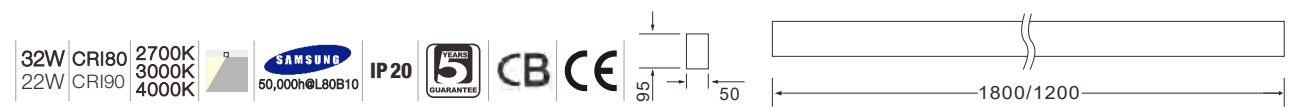
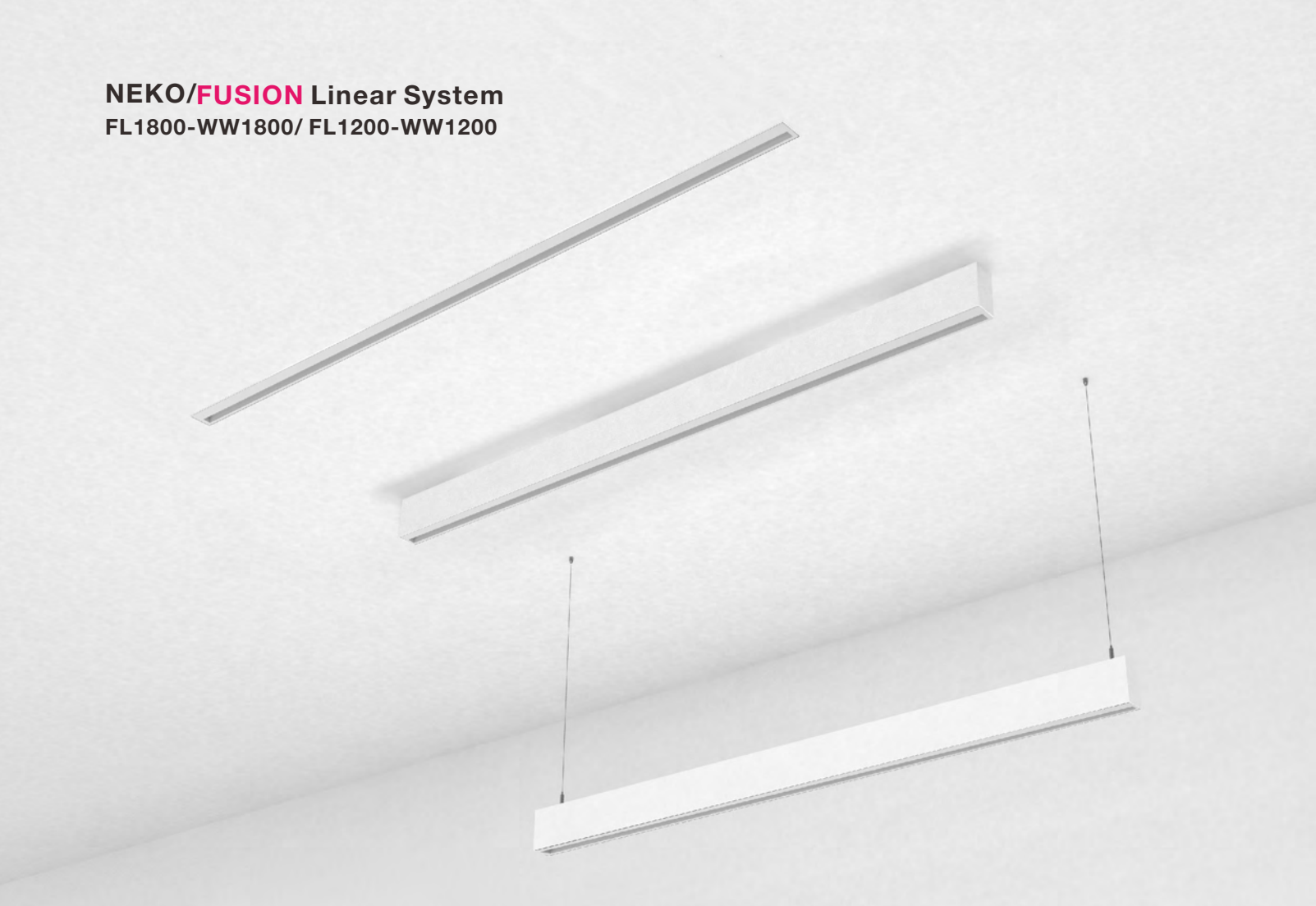

LED Power	System Power	LED Voltage	LED Current	CRI	CCT	Beam	LED Output	System Output	Length	Model
32 W	36 W	46V	700 mA	80	2700K	WW	4600lm	2300lm	1800mm	FL1800(X)-WW1800-32W-827
						WW	4800lm	2500lm	1800mm	FL1800(X)-WW1800-32W-830
						WW	5000lm	2700lm	1800mm	FL1800(X)-WW1800-32W-840
48 W	52 W	46V	700+350 mA	80	2700K	WW	6200lm	3300lm	1800mm	FL1800(X)-WW1800-48W-827
						WW	6400lm	3500lm	1800mm	FL1800(X)-WW1800-48W-830
						WW	6600lm	3700lm	1800mm	FL1800(X)-WW1800-48W-840
22 W	26 W	46V	500 mA	80	2700K	WW	3200lm	1700lm	1200mm	FL1200(X)-WW1200-22W-827
						WW	3400lm	1800lm	1200mm	FL1200(X)-WW1200-22W-830
						WW	3600lm	1900lm	1200mm	FL1200(X)-WW1200-22W-840
32 W	36 W	46V	700 mA	80	2700K	WW	4600lm	2300lm	1200mm	FL1200(X)-WW1200-32W-827
						WW	4800lm	2500lm	1200mm	FL1200(X)-WW1200-32W-830
						WW	5000lm	2700lm	1200mm	FL1200(X)-WW1200-32W-840

Remark: X= P (Pendant) X= S (Surface mounted) X= R (Recessed mounted)





**NEKO/FUSION Linear System**  
**FL1200-2\*AL300/ FL1500-2\*AL300**

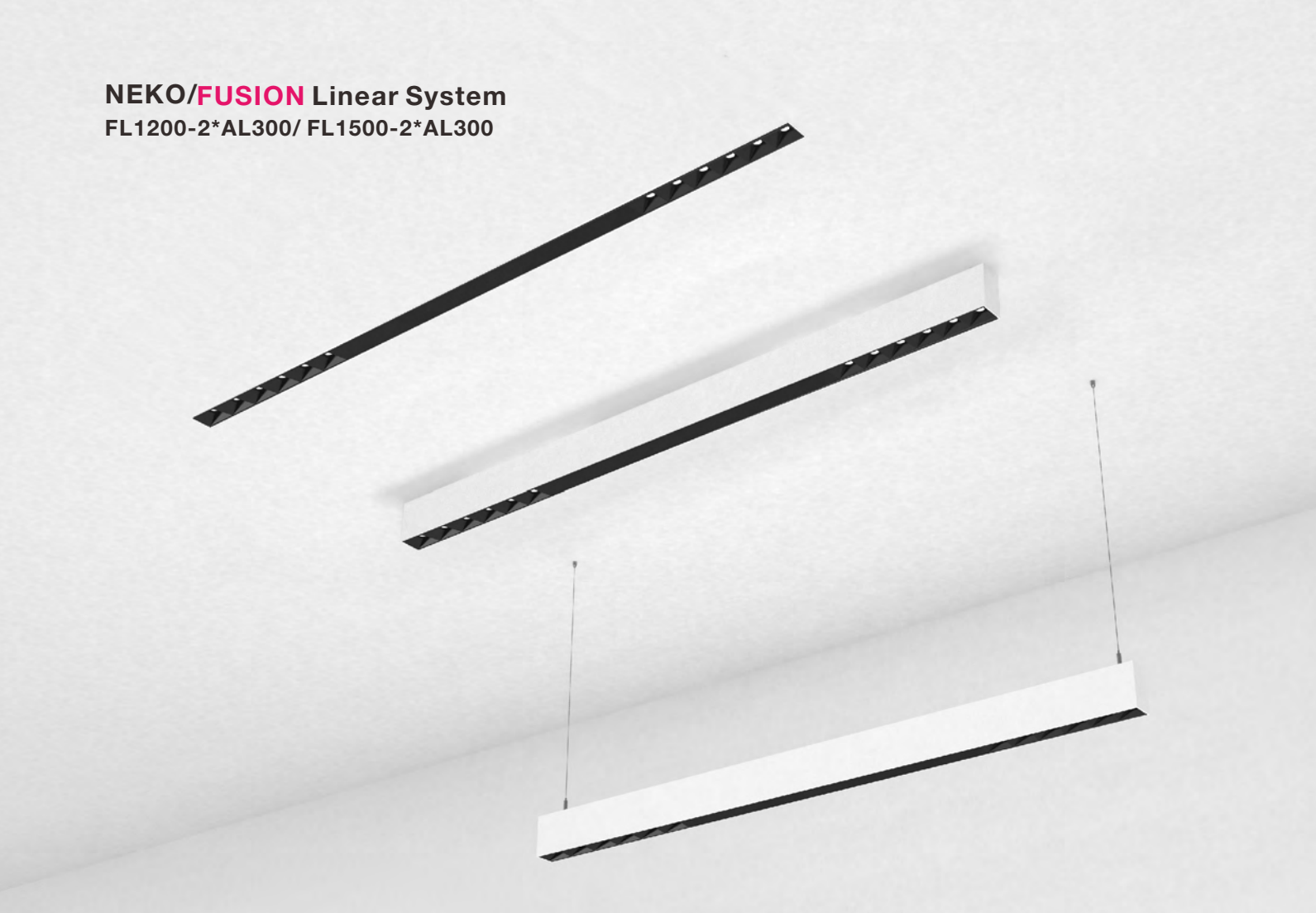

LED Power	System Power	LED Voltage	LED Current	CRI	CCT	Beam	LED Output	System Output	Length	Model	
26 W	30 W	36 V	700 mA	80	2700K	15°	2800lm	2000lm	1200mm	FL1200(X)-2*AL300-26W-827-15D	
						30°	2800lm	2000lm	1200mm	FL1200(X)-2*AL300-26W-827-30D	
						3000K	15°	3000lm	2200lm	1200mm	FL1200(X)-2*AL300-26W-830-15D
							30°	3000lm	2200lm	1200mm	FL1200(X)-2*AL300-26W-830-30D
						4000K	15°	3400lm	2400lm	1200mm	FL1200(X)-2*AL300-26W-840-15D
							30°	3400lm	2400lm	1200mm	FL1200(X)-2*AL300-26W-840-30D
26 W	30 W	36 V	700 mA	80	2700K	15°	2800lm	2000lm	1500mm	FL1500(X)-2*AL300-26W-827-15D	
						30°	2800lm	2000lm	1500mm	FL1500(X)-2*AL300-26W-827-30D	
						3000K	15°	3000lm	2200lm	1500mm	FL1500(X)-2*AL300-26W-830-15D
							30°	3000lm	2200lm	1500mm	FL1500(X)-2*AL300-26W-830-30D
						4000K	15°	3400lm	2400lm	1500mm	FL1500(X)-2*AL300-26W-840-15D
							30°	3400lm	2400lm	1500mm	FL1500(X)-2*AL300-26W-840-30D

Remark: X= P (Pendant) X= S (Surface mounted) X= R (Recessed mounted)

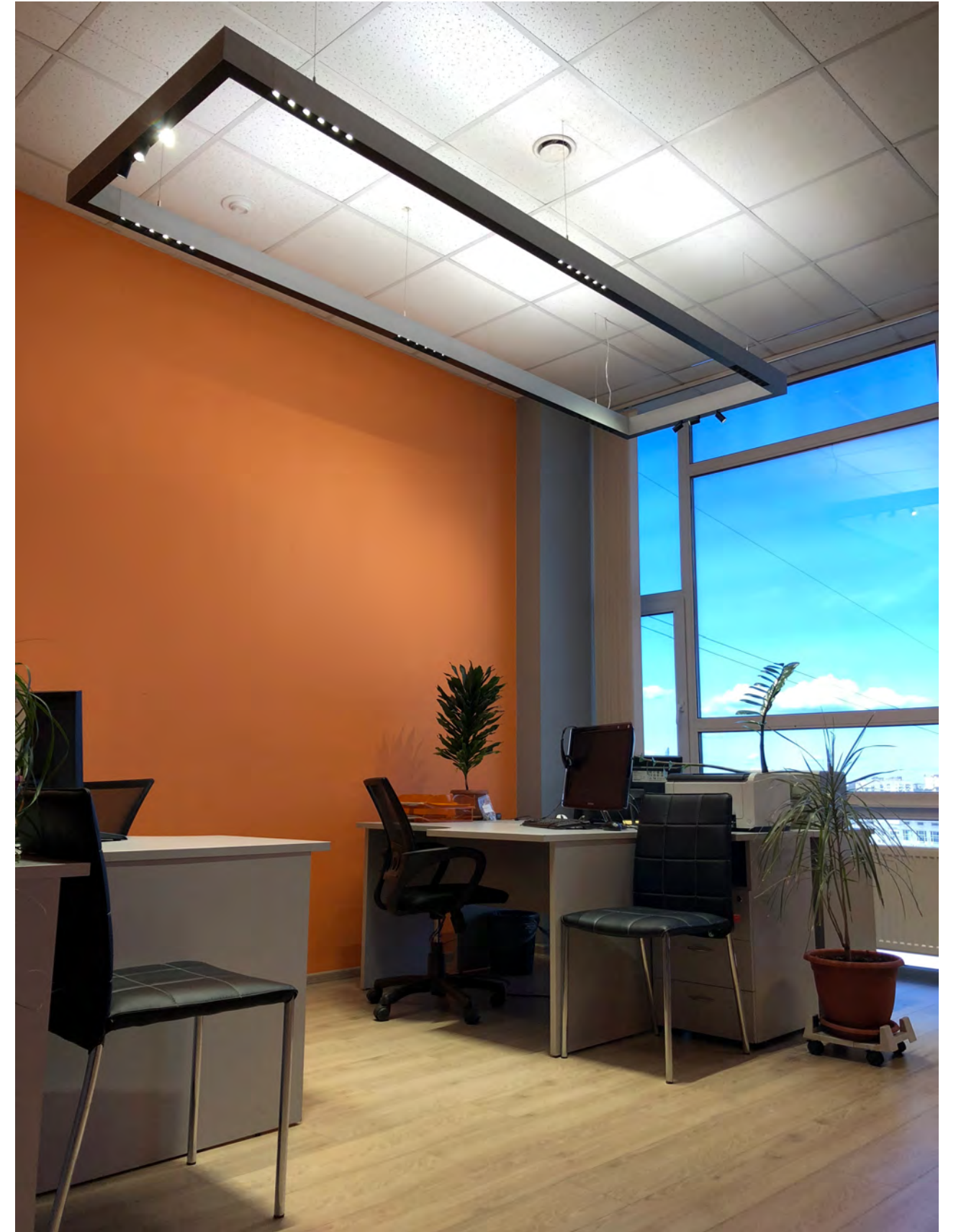



**NEKO/FUSION Linear System**  
**FL1200-2\*AL300+GL600**



LED Power	System Power	LED Voltage	LED Current	CRI	CCT	Beam	LED Output	System Output	Model	
37 W	41 W	47 V	700 mA	80	2700K	15°+105°	3800lm	2800lm	FL1200(X)-2*AL300+GL600-37W-827-15D	
						30°+105°	3800lm	2800lm	FL1200(X)-2*AL300+GL600-37W-827-30D	
						3000K	15°+105°	4100lm	3000lm	FL1200(X)-2*AL300+GL600-37W-830-15D
						30°+105°	4100lm	3000lm	FL1200(X)-2*AL300+GL600-37W-830-30D	
						4000K	15°+105°	4400lm	3200lm	FL1200(X)-2*AL300+GL600-37W-840-15D
						30°+105°	4400lm	3200lm	FL1200(X)-2*AL300+GL600-37W-840-30D	

Remark: X= P (Pendant) X= S (Surface mounted) X= R (Recessed mounted)





**NEKO/FUSION Linear System**  
More modules combination available

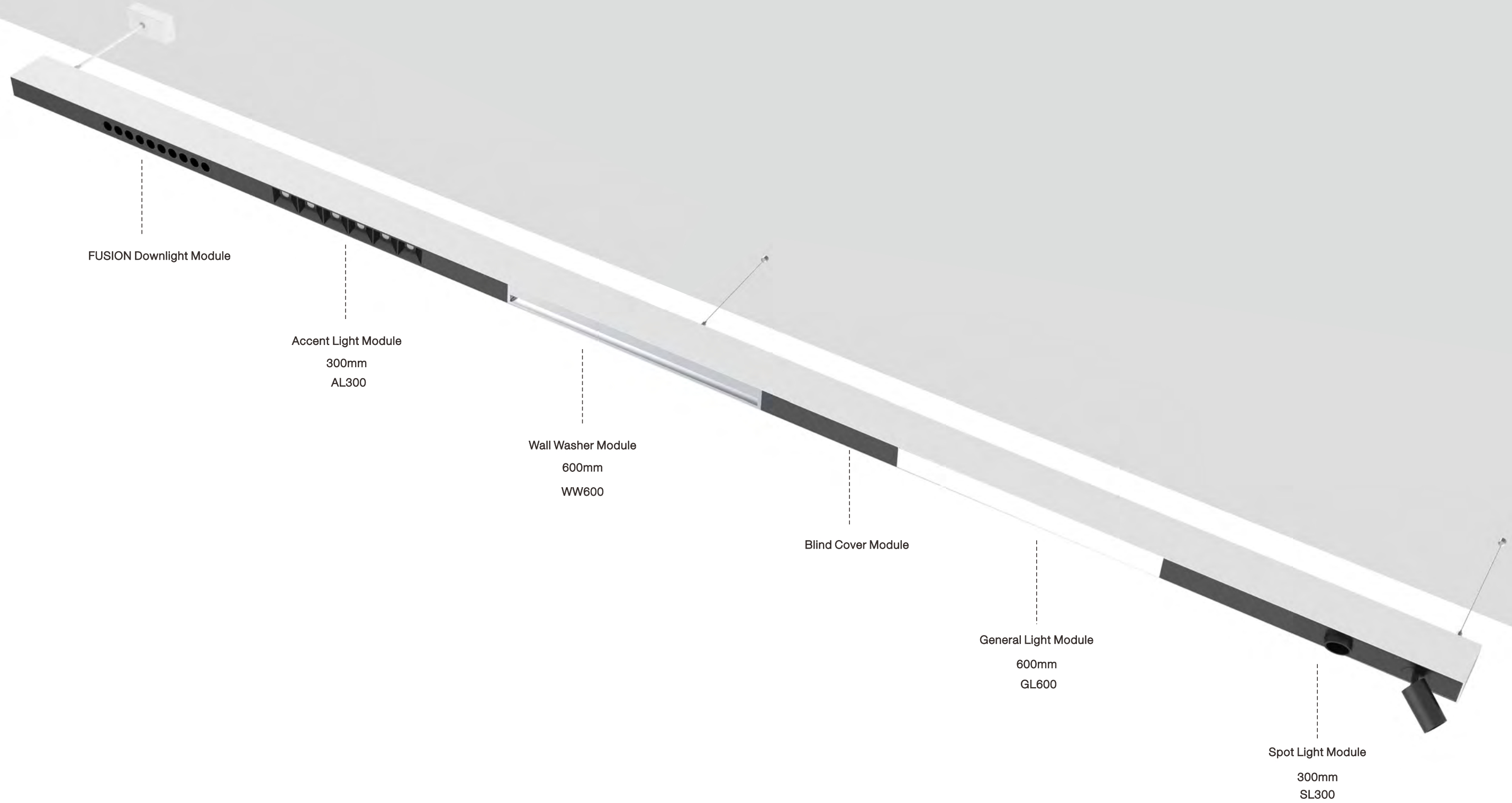

Linear System with more modules combination available.  
All available with Suspended, surface mounted and recessed mounted versions.

NEKO / MODULINE Linear System  
48V Low Voltage Modular Linear System



Linear Accent Light  
ML35-AL300

Linear General Light  
ML35-GL300

Pendant Spotlight  
ML35-PS72

Round Spotlight  
ML35-RS55

Round Spotlight  
ML35-RS55

Pendant Spotlight  
ML35-PS55

Pendant Spotlight  
ML35-PS72

Pendant-Decoration  
ML35-PD

Pendant Spotlight  
ML35-PS55

Round Spotlight  
ML35-RS35

Round Spotlight  
ML35-RS35

Linear Accent Light  
ML35-AL600

Linear General Light  
ML35-GL600



**NEKO / MODULINE Linear System**  
48V Low Voltage Modular Linear System



Linear General Light  
ML35-GL300/ ML35-GL600

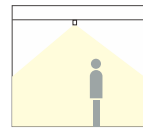
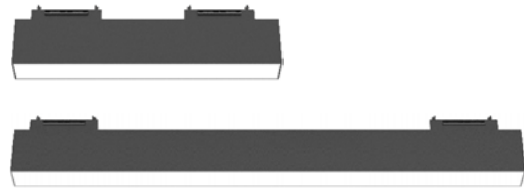

Linear Accent Light  
ML35-AL300/ ML35-AL600

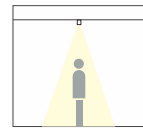

Pendant-Decoration  
ML35-PD



Pendant Spotlight  
ML35-PS72



Pendant Spotlight  
ML35-PS55



Round Spotlight  
ML35-RS35



Round Spotlight  
ML35-RS55

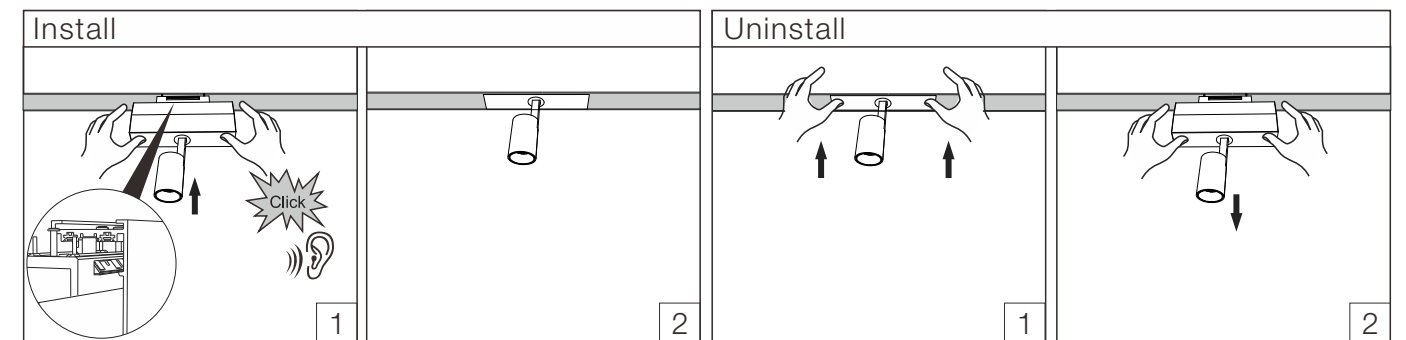

Trimless Recessed

Surface Mounted

Pendant



Trimless Recessed Installations

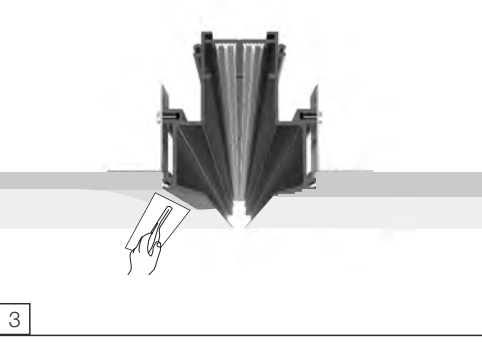
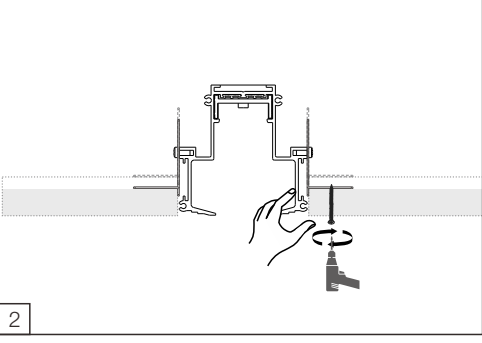
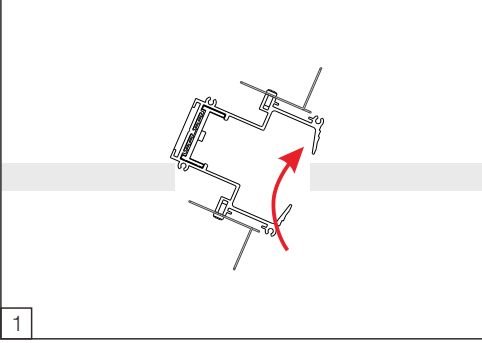



**NEKO / MODULINE Linear System**  
48V Low Voltage Modular Linear System  
Trimless System



**Short Info**

- 48V low voltage system
- Track Rail made of extruded aluminium with 36mm width groove
- Suitable for trimless installation in ceilings with 1-40mm thickness
- Track Rail available with standard lengths 3000mm and 1000mm
- 'L' shape corner module available for flexible system
- Linear Connector and Continuous Kit provided for continuous Track Rail connection
- Various lighting insets with multiple lighting applications, Tool-free insert mounting by clip-in mechanism
- Insets available with Non Dim and 1-10V Dim

**Insets**

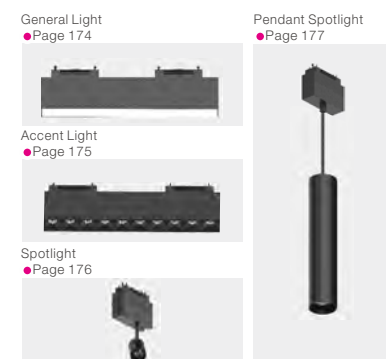

**Features**

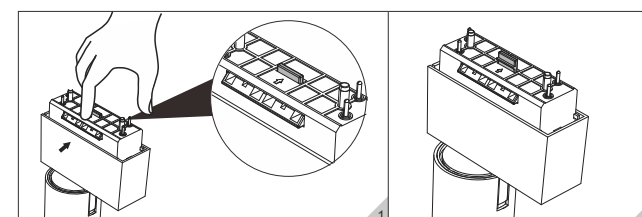

•Insets with clip-in mechanism

**Short Info**

MODULINE trimless recessed system

**Electrical**

Non Dim  
1-10V Dim

**Fixture Colour**

Black

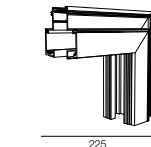
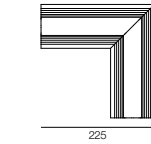
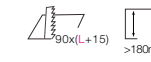

**MODULINE trimless recessed system**

Please order installation track rail, light insets and mounting accessories separately.

**Trimless Installation Track Rail**

L (mm)	Description	Code/ Model
1000	Track Rail	ML35-TR1000
3000	Track Rail	ML35-TR3000
200*200	'L' shape corner module-horizontal	ML35-CM-R
200*200	'L' shape corner module-vertical	ML35-CM-RV

•Track Rail including endcaps.

**Accessories**

**Endcap**

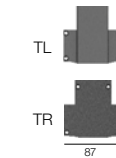

Description	Code/ Model
At the side with Power Feeder Unit	ML35-Endcap-TL
At the side without Power Feeder Unit	ML35-Endcap-TR

**Power Feeder Unit**

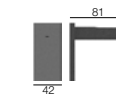

Description	Code/ Model
Power Feeder Unit with feeder cables 500mm	ML35-Endcap E-R

**Track Rail Wires Cover**



Description	Code/ Model
Track Rail Wires Cover 925mm	ML35-RC1000
Track Rail Wires Cover 2925mm	ML35-RC3000

•Wires cover can be shortened as desired.

**Connector Set**



Description	Code/ Model
Linear Connector with screws	ML35-LC
Continuous Kit, Electrical	ML35-CK

•Need to be used together as a set.

**Trimless Installation Kit**



Description	Code/ Model
Trimless installation kit, 2pcs/ set. 1 set for per meter Track Rail length.	ML35-TIK

**NEKO / MODULINE Linear System**  
48V Low Voltage Modular Linear System  
Surface Mounted System



**Short Info**

- 48V low voltage system
- Track Rail made of extruded aluminium with 36mm width groove
- Suitable for surface mounted or suspended with 1500mm steel cable
- Track Rail available with standard lengths 3000mm and 1000mm
- ‘L’ shape corner module available for flexible system
- Linear Connector and Continuous Kit provided for continuous Track Rail connection
- Various lighting insets with multiple lighting applications, Tool-free insert mounting by clip-in mechanism
- Insets available with Non Dim and 1-10V Dim

**Insets**

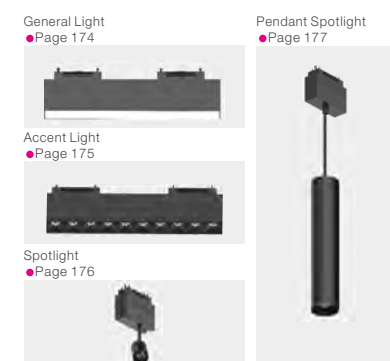

**Features**

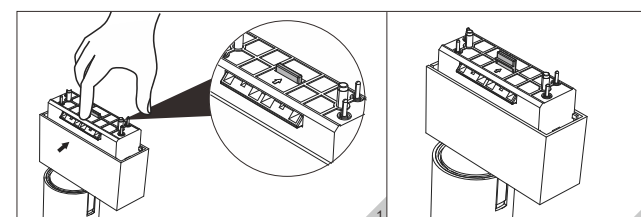

-Insets with clip-in mechanism

**Short Info**

MODULINE surface mounted system

**Electrical**

- Non Dim
- 1-10V Dim

**Fixture Colour**

Black



**MODULINE surface mounted system**

Please order installation track rail, light insets and mounting accessories separately.



**Surface mounted Installation Track Rail**

L (mm)	Description	Code/ Model
1000	Track Rail	ML35-R1000
3000	Track Rail	ML35-R3000
200*200	‘L’ shape corner module-horizontal	ML35-CM-S
200*200	‘L’ shape corner module-vertical	ML35-CM-SV

\*Track Rail including endcaps.

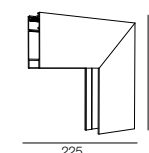
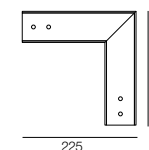

**Accessories**

**Endcap**

Description	Code/ Model
At the side without Power Feeder Unit	ML35-Endcap



**Power Feeder Unit**

Description	Code/ Model
Power Feeder Unit with feeder cables 500mm for surface mounted	ML35-Endcap E-R
Power Feeder Unit with feeder cables 2000mm for suspended	ML35-Endcap E-P

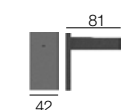

**Track Rail Wires Cover**

Description	Code/ Model
Track Rail Wires Cover 925mm	ML35-RC1000
Track Rail Wires Cover 2925mm	ML35-RC3000



\*Wires cover can be shortened as desired.

**Connector Set**

Description	Code/ Model
Linear Connector with screws	ML35-LC
Continuous Kit, Electrical	ML35-CK



\*Need to be used together as a set.

**Installation Kit**

Description	Code/ Model
Surface mounted installation kit 1000mm/pcs	ML35-SMK





**NEKO / MODULINE Linear System**  
48V Low Voltage Modular Linear System  
Suspended System



**Short Info**

- 48V low voltage system
- Track Rail made of extruded aluminium with 36mm width groove
- Suitable for surface mounted or suspended with 1500mm steel cable
- Track Rail available with standard lengths 3000mm and 1000mm
- 'L' shape corner module available for flexible system
- Linear Connector and Continuous Kit provided for continuous Track Rail connection
- Various lighting insets with multiple lighting applications, Tool-free insert mounting by clip-in mechanism
- Insets available with Non Dim and 1-10V Dim

**Insets**

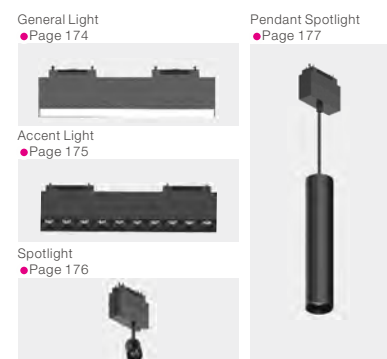

**Features**

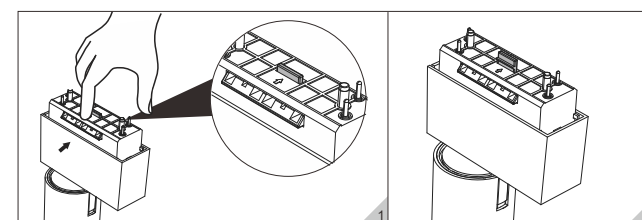

•Insets with clip-in mechanism

**Short Info**

MODULINE suspended system

**Electrical**

- Non Dim
- 1-10V Dim

**Fixture Colour**

Black



**MODULINE suspended system**

Please order installation track rail, light insets and mounting accessories separately.

**Suspended Installation Track Rail**

L (mm)	Description	Code/ Model
1000	Track Rail	ML35-R1000
3000	Track Rail	ML35-R3000
200*200	'L' shape corner module	ML35-CM-S

•Track Rail including endcaps.

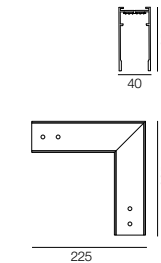

**Accessories**

**Endcap**

Description	Code/ Model
At the side without Power Feeder Unit	ML35-Endcap

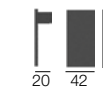

**Power Feeder Unit**

Description	Code/ Model
Power Feeder Unit with feeder cables 500mm for surface mounted	ML35-Endcap E-R
Power Feeder Unit with feeder cables 2000mm for suspended	ML35-Endcap E-P

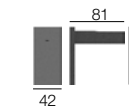

**Track Rail Wires Cover**

Description	Code/ Model
Track Rail Wires Cover 925mm	ML35-RC1000
Track Rail Wires Cover 2925mm	ML35-RC3000

•Wires cover can be shortened as desired.



**Connector Set**

Description	Code/ Model
Linear Connector with screws	ML35-LC
Continuous Kit, Electrical	ML35-CK

•Need to be used together as a set.



**Installation Kit**

Description	Code/ Model
Suspension installation kit with 1500mm steel cable 2pcs/ set	ML35-PK



**NEKO / MODULINE Linear System**  
**48V Low Voltage Modular Linear System**  
**General Light Insets**

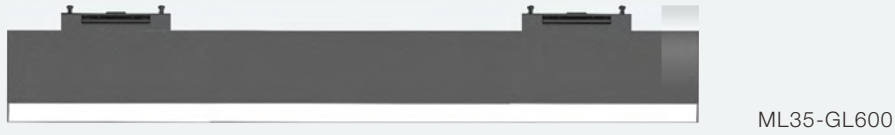

13W CRI90 2700K 3000K 4000K  
 26W CRI80  
  
  
 50,000h@L80B10

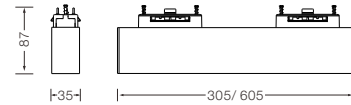

LED Power System Power LED Voltage	CRI	CCT	Beam	LED Output	System Output	Code
12 W 13 W 48 V	80	2700K	110°	1600lm	1100lm	MLGB-827A113F-BN
		3000K	110°	1700lm	1200lm	MLGB-830A113F-BN
		4000K	110°	1800lm	1300lm	MLGB-840A113F-BN
	90	2700K	110°	1400lm	950lm	MLGB-927A113F-BN
		3000K	110°	1500lm	1000lm	MLGB-930A113F-BN
		4000K	110°	1600lm	1100lm	MLGB-940A113F-BN
<b>Code Remark:</b> ON-OFF Version						
12 W 13 W 48 V	80	2700K	110°	1600lm	1100lm	MLGA-827A113A-BN
		3000K	110°	1700lm	1200lm	MLGA-830A113A-BN
		4000K	110°	1800lm	1300lm	MLGA-840A113A-BN
	90	2700K	110°	1400lm	950lm	MLGA-927A113A-BN
		3000K	110°	1500lm	1000lm	MLGA-930A113A-BN
		4000K	110°	1600lm	1100lm	MLGA-940A113A-BN
<b>Code Remark:</b> 1-10V Dim Version						
24 W 26 W 48 V	80	2700K	110°	3200lm	2200lm	MLGD-827A126F-BN
		3000K	110°	3400lm	2400lm	MLGD-830A126F-BN
		4000K	110°	3600lm	2600lm	MLGD-840A126F-BN
	90	2700K	110°	2800lm	1900lm	MLGD-927A126F-BN
		3000K	110°	3000lm	2000lm	MLGD-930A126F-BN
		4000K	110°	3200lm	2200lm	MLGD-940A126F-BN
<b>Code Remark:</b> ON-OFF Version						
24 W 26 W 48 V	80	2700K	110°	3200lm	2200lm	MLGC-827A126A-BN
		3000K	110°	3400lm	2400lm	MLGC-830A126A-BN
		4000K	110°	3600lm	2600lm	MLGC-840A126A-BN
	90	2700K	110°	2800lm	1900lm	MLGC-927A126A-BN
		3000K	110°	3000lm	2000lm	MLGC-930A126A-BN
		4000K	110°	3200lm	2200lm	MLGC-940A126A-BN
<b>Code Remark:</b> 1-10V Dim Version						

**NEKO / MODULINE Linear System**  
**48V Low Voltage Modular Linear System**  
**Accent Light Insets**



15W CRI90 2700K 3000K 4000K  
 29W CRI80  
  
  
 50,000h@L80B10  
 UGR < 19

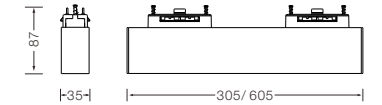

LED Power System Power LED Voltage	CRI	CCT	Beam	LED Output	System Output	Code
14 W 15 W 48 V	80	2700K	40°	1700lm	1200lm	MLAB-8274015F-BB
		3000K	40°	1800lm	1300lm	MLAB-8304015F-BB
		4000K	40°	1900lm	1400lm	MLAB-8404015F-BB
	90	2700K	40°	1400lm	950lm	MLAB-9274015F-BB
		3000K	40°	1500lm	1000lm	MLAB-9304015F-BB
		4000K	40°	1600lm	1100lm	MLAB-9404015F-BB
<b>Code Remark:</b> ON-OFF Version						
14 W 15 W 48 V	80	2700K	40°	1700lm	1200lm	MLAA-8274015A-BB
		3000K	40°	1800lm	1300lm	MLAA-8304015A-BB
		4000K	40°	1900lm	1400lm	MLAA-8404015A-BB
	90	2700K	40°	1400lm	950lm	MLAA-9274015A-BB
		3000K	40°	1500lm	1000lm	MLAA-9304015A-BB
		4000K	40°	1600lm	1100lm	MLAA-9404015A-BB
<b>Code Remark:</b> 1-10V Dim Version						
27 W 29 W 48 V	80	2700K	40°	3400lm	2400lm	MLAD-8274029F-BB
		3000K	40°	3600lm	2600lm	MLAD-8304029F-BB
		4000K	40°	3800lm	2800lm	MLAD-8404029F-BB
	90	2700K	40°	2800lm	1900lm	MLAD-9274029F-BB
		3000K	40°	3000lm	2000lm	MLAD-9304029F-BB
		4000K	40°	3200lm	2200lm	MLAD-9404029F-BB
<b>Code Remark:</b> ON-OFF Version						
27 W 29 W 48 V	80	2700K	40°	3400lm	2400lm	MLAC-8274029A-BB
		3000K	40°	3600lm	2600lm	MLAC-8304029A-BB
		4000K	40°	3800lm	2800lm	MLAC-8404029A-BB
	90	2700K	40°	2800lm	1900lm	MLAC-9274029A-BB
		3000K	40°	3000lm	2000lm	MLAC-9304029A-BB
		4000K	40°	3200lm	2200lm	MLAC-9404029A-BB
<b>Code Remark:</b> 1-10V Dim Version						



**NEKO / MODULINE Linear System**  
48V Low Voltage Modular Linear System  
Spotlight Insets



**NEKO / MODULINE Linear System**  
48V Low Voltage Modular Linear System  
Pendant Spotlight Insets

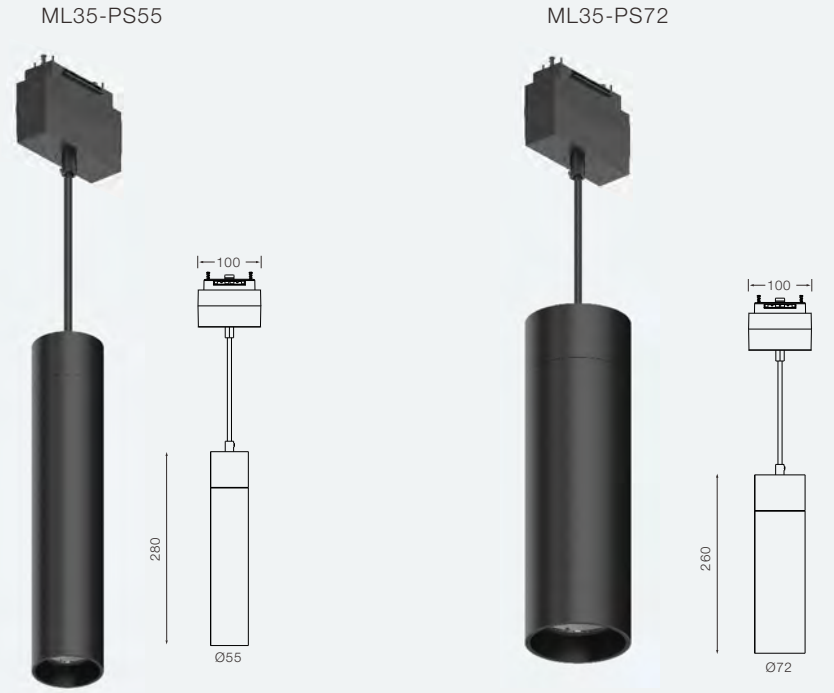

4.5W CRI90 2700K  
14W CRI80 3000K  
4000K  
CREE 50,000h@L80B10  
CITIZEN 50,000h@L80B10  
UGR < 19  
IP20  
5 YEAR WARRANTY  
CB CE

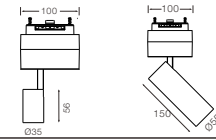

13W CRI90 2700K  
19W CRI80 3000K  
4000K  
CITIZEN 50,000h@L80B10  
UGR < 19  
IP20  
5 YEAR WARRANTY  
CB CE

LED Power	System Power	LED Voltage	CRI	CCT	Beam	LED Output	System Output	Code						
4 W	4.5 W	48 V	90	2700K	20°	450lm	330lm	MLRB-9272005F-BB						
					35°	450lm	330lm	MLRB-9273505F-BB						
					3000K	20°	500lm	350lm	MLRB-9302005F-BB					
						35°	500lm	350lm	MLRB-9303505F-BB					
					4000K	20°	550lm	380lm	MLRB-9402005F-BB					
						35°	550lm	380lm	MLRB-9403505F-BB					
					Code Remark: ON-OFF Version									
					4 W	4.5 W	48 V	90	2700K	20°	450lm	330lm	MLRA-9272005A-BB	
										35°	450lm	330lm	MLRA-9273505A-BB	
										3000K	20°	500lm	350lm	MLRA-9302005A-BB
											35°	500lm	350lm	MLRA-9303505A-BB
										4000K	20°	550lm	380lm	MLRA-9402005A-BB
35°	550lm	380lm	MLRA-9403505A-BB											
Code Remark: 1-10V Dim Version														
13W	14 W	48 V	90	2700K						18°	1600lm	900lm	MLRD-9271814F-BB	
										24°	1600lm	900lm	MLRD-9272414F-BB	
										36°	1600lm	900lm	MLRD-9273614F-BB	
										3000K	18°	1700lm	950lm	MLRD-9301814F-BB
											24°	1700lm	950lm	MLRD-9302414F-BB
					36°	1700lm	950lm	MLRD-9303614F-BB						
					4000K	18°	1800lm	1050lm	MLRD-9401814F-BB					
						24°	1800lm	1050lm	MLRD-9402414F-BB					
					36°	1800lm	1050lm	MLRD-9403614F-BB						
					Code Remark: ON-OFF Version									
					13W	14 W	48 V	90	2700K	18°	1600lm	900lm	MLRC-9271814A-BB	
										24°	1600lm	900lm	MLRC-9272414A-BB	
36°	1600lm	900lm	MLRC-9273614A-BB											
3000K	18°	1700lm	950lm	MLRC-9301814A-BB										
	24°	1700lm	950lm	MLRC-9302414A-BB										
36°	1700lm	950lm	MLRC-9303614A-BB											
4000K	18°	1800lm	1050lm	MLRC-9401814A-BB										
	24°	1800lm	1050lm	MLRC-9402414A-BB										
36°	1800lm	1050lm	MLRC-9403614A-BB											
Code Remark: 1-10V Dim Version														



LED Power	System Power	LED Voltage	CRI	CCT	Beam	LED Output	System Output	Code					
12.5W	13 W	48 V	90	2700K	18°	1200lm	950lm	MLPB-9271813F-BB					
					24°	1200lm	950lm	MLPB-9272413F-BB					
					36°	1200lm	950lm	MLPB-9273613F-BB					
					3000K	18°	1300lm	1000lm	MLPB-9301813F-BB				
						24°	1300lm	1000lm	MLPB-9302413F-BB				
					36°	1300lm	1000lm	MLPB-9303613F-BB					
					4000K	18°	1400lm	1100lm	MLPB-9401813F-BB				
						24°	1400lm	1100lm	MLPB-9402413F-BB				
					36°	1400lm	1100lm	MLPB-9403613F-BB					
					Code Remark: ON-OFF Version								
					12.5W	13 W	48 V	90	2700K	18°	1200lm	950lm	MLPA-9271813A-BB
										24°	1200lm	950lm	MLPA-9272413A-BB
36°	1200lm	950lm	MLPA-9273613A-BB										
3000K	18°	1300lm	1000lm	MLPA-9301813A-BB									
	24°	1300lm	1000lm	MLPA-9302413A-BB									
36°	1300lm	1000lm	MLPA-9303613A-BB										
4000K	18°	1400lm	1100lm	MLPA-9401813A-BB									
	24°	1400lm	1100lm	MLPA-9402413A-BB									
36°	1400lm	1100lm	MLPA-9403613A-BB										
Code Remark: 1-10V Dim Version													
18W	19 W	48 V	90	2700K						15°	1900lm	1500lm	MLPD-9271519F-BB
										25°	1900lm	1500lm	MLPD-9272519F-BB
					30°	1900lm	1500lm	MLPD-9273019F-BB					
					3000K	15°	2000lm	1600lm	MLPD-9301519F-BB				
						25°	2000lm	1600lm	MLPD-9302519F-BB				
					30°	2000lm	1600lm	MLPD-9303019F-BB					
					4000K	15°	2100lm	1700lm	MLPD-9401519F-BB				
						25°	2100lm	1700lm	MLPD-9402519F-BB				
					30°	2100lm	1700lm	MLPD-9403019F-BB					
					Code Remark: ON-OFF Version								
					18W	19 W	48 V	90	2700K	15°	1900lm	1500lm	MLPC-9271519A-BB
										25°	1900lm	1500lm	MLPC-9272519A-BB
30°	1900lm	1500lm	MLPC-9273019A-BB										
3000K	15°	2000lm	1600lm	MLPC-9301519A-BB									
	25°	2000lm	1600lm	MLPC-9302519A-BB									
30°	2000lm	1600lm	MLPC-9303019A-BB										
4000K	15°	2100lm	1700lm	MLPC-9401519A-BB									
	25°	2100lm	1700lm	MLPC-9402519A-BB									
30°	2100lm	1700lm	MLPC-9403019A-BB										
Code Remark: 1-10V Dim Version													



**NEKO / MODULINE Linear System**  
**48V Low Voltage Modular Linear System**  
 Pendant Decoration Insets **Coming Soon in June of 2019**



ML35-PD

15W CRI90 2700K 3000K 4000K CRI80 100° SAMSUNG 50,000h@L80B10 IP20 5 YEAR WARRANTY CB CE

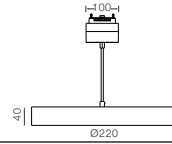

ML35-PD

LED Power	System Power	LED Voltage	CRI	CCT	Beam	LED Output	System Output	Code
14 W	15 W	48 V	80	2700K	100°	1700lm	1200lm	MLDB-827A015F-BN
				3000K	100°	1800lm	1300lm	MLDB-830A015F-BN
				4000K	100°	1900lm	1400lm	MLDB-840A015F-BN
			90	2700K	100°	1500lm	1050lm	MLDB-927A015F-BN
				3000K	100°	1600lm	1100lm	MLDB-930A015F-BN
				4000K	100°	1700lm	1200lm	MLDB-940A015F-BN
Code Remark: ON-OFF Version								
14 W	15 W	48 V	80	2700K	100°	1700lm	1200lm	MLDB-827A015A-BN
				3000K	100°	1800lm	1300lm	MLDA-830A015A-BN
				4000K	100°	1900lm	1400lm	MLDA-840A015A-BN
			90	2700K	100°	1500lm	1050lm	MLDA-927A015A-BN
				3000K	100°	1600lm	1100lm	MLDA-930A015A-BN
				4000K	100°	1700lm	1200lm	MLDA-940A015A-BN
Code Remark: 1-10V Dim Version								







**R**ound aluminum housing ensures the optimal cooling of the LEDs  
Available in standard version and decorative version  
Suitable for ceiling-mounted, wall-mounted, suspended  
4 diameters for options (350 mm, 450 mm, 600 mm, 900 mm)  
Microprismatic cover for super eye comfort

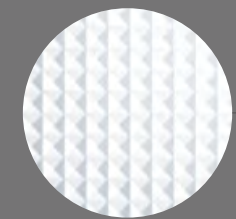

Microprismatic Cover  
UGR<19



white



black



black-gold



white



black

Installation:

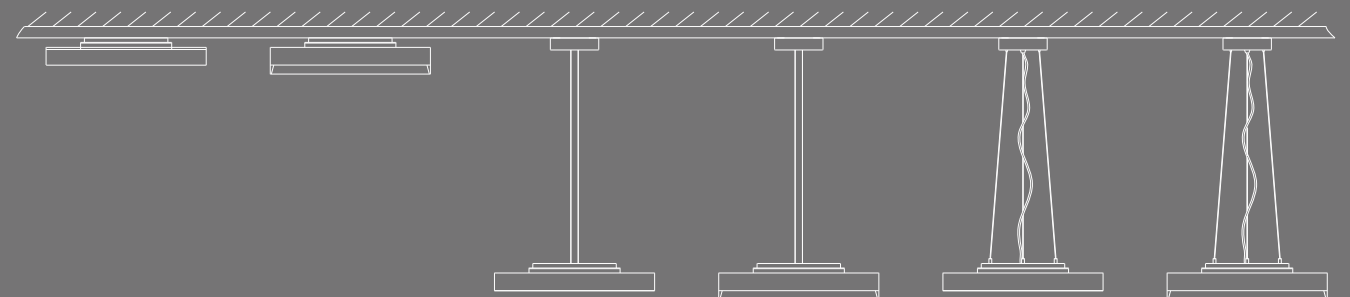



**Installation :**

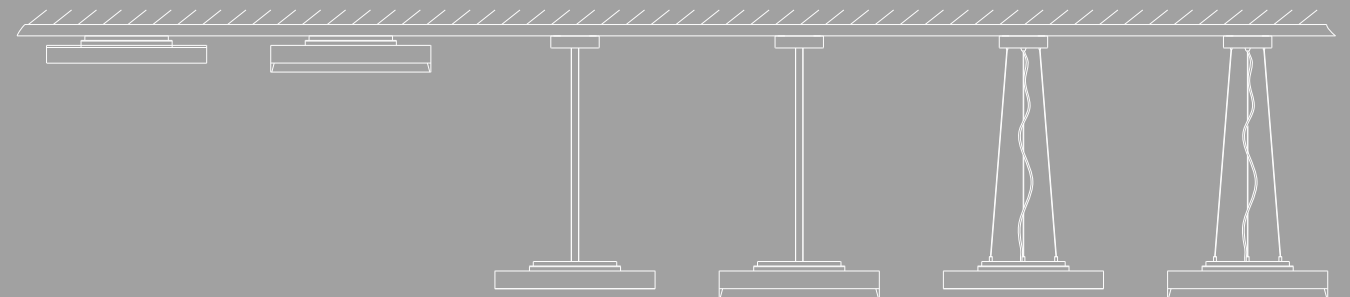



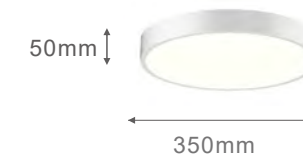
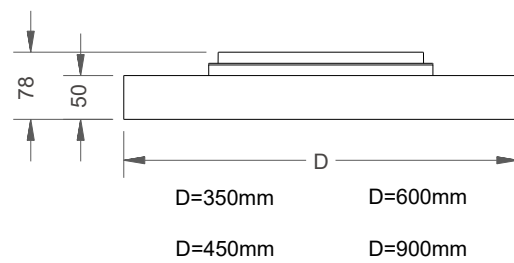

8W UP  
12W DOWN(350mA) 1300Lm  
18W DOWN(500mA) 1900Lm  
ON-OFF/PHASE DIM/1-10V/DALI

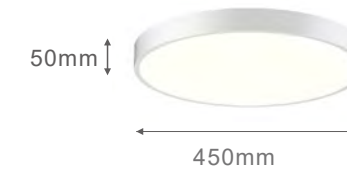

8W UP  
18W DOWN(500mA) 1900Lm  
25W DOWN(700mA) 2600Lm  
ON-OFF/PHASE DIM/1-10V/DALI

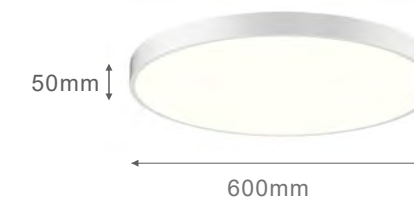

12W UP  
25W DOWN(700mA) 2600Lm  
38W DOWN(1050mA) 3800Lm  
ON-OFF/PHASE DIM/1-10V/DALI

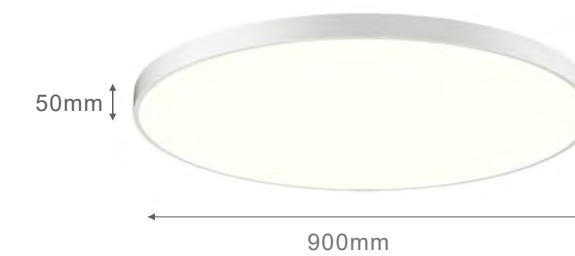

12W UP  
65W DOWN(1350mA) 5800Lm  
ON-OFF/1-10V/DALI

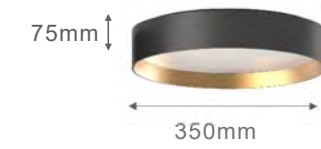
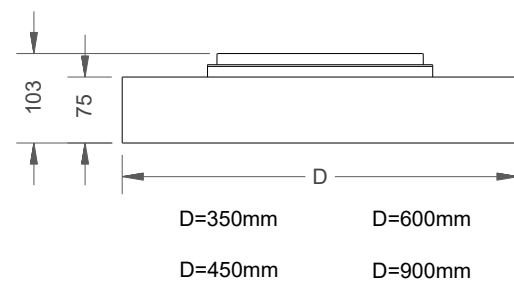

8W UP  
12W DOWN(350mA) 1300Lm  
18W DOWN(500mA) 1900Lm  
ON-OFF/PHASE DIM/1-10V/DALI

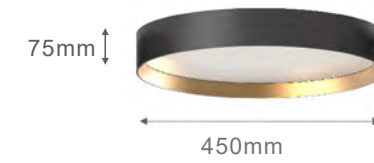

8W UP  
18W DOWN(500mA) 1900Lm  
25W DOWN(700mA) 2600Lm  
ON-OFF/PHASE DIM/1-10V/DALI

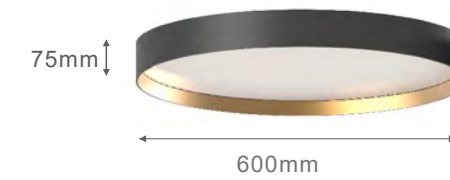

12W UP  
25W DOWN(700mA) 2600Lm  
38W DOWN(1050mA) 3800Lm  
ON-OFF/PHASE DIM/1-10V/DALI

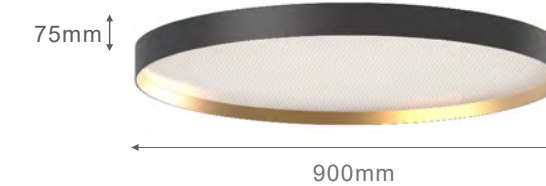





12W UP  
65W DOWN(1350mA) 5800Lm  
ON-OFF/1-10V/DALI

**NEKO / GAME350**  
Ceiling Light System



12W CRI80 2700K  
18W CRI90 3000K  
4000K  
90° OSRAM UGR < 19 IP40 5 YEAR GUARANTEE CB CE

	LED Power	System Power	LED Voltage	LED Current	CRI	CCT	Beam	LED Output	System Output	Code
 Black	12 W	14 W	36 V	350 mA	80	2700K	90°	1200lm	1100lm	GASM-8279012X-BN
						3000K	90°	1300lm	1200lm	GASM-8309012X-BN
						4000K	90°	1400lm	1300lm	GASM-8409012X-BN
 White	18 W	20 W	36 V	500 mA	80	2700K	90°	1800lm	1600lm	GASM-8279018X-BN
						3000K	90°	1900lm	1700lm	GASM-8309018X-BN
						4000K	90°	2000lm	1800lm	GASM-8409018X-BN
 Black	12 W	14 W	36 V	350 mA	80	2700K	90°	1200lm	1100lm	GASM-8279012X-WN
						3000K	90°	1300lm	1200lm	GASM-8309012X-WN
						4000K	90°	1400lm	1300lm	GASM-8409012X-WN
 White	18 W	20 W	36 V	500 mA	80	2700K	90°	1800lm	1600lm	GASM-8279018X-WN
						3000K	90°	1900lm	1700lm	GASM-8309018X-WN
						4000K	90°	2000lm	1800lm	GASM-8409018X-WN

Code Remark: X=F(ON-OFF) X=P(Phase Dim) X=A(1-10V Dim) X=D(DALI Dim)



Black



White



Black



White

LED Power	System Power	LED Voltage	LED Current	CRI	CCT	Beam	LED Output	System Output	Code
12 W	14 W	36 V	350 mA	80	2700K	90°	1200lm	1100lm	GAPW-8279012X-BN
					3000K	90°	1300lm	1200lm	GAPW-8309012X-BN
					4000K	90°	1400lm	1300lm	GAPW-8409012X-BN
18 W	20 W	36 V	500 mA	80	2700K	90°	1800lm	1600lm	GAPW-8279018X-BN
					3000K	90°	1900lm	1700lm	GAPW-8309018X-BN
					4000K	90°	2000lm	1800lm	GAPW-8409018X-BN

12 W	14 W	36 V	350 mA	80	2700K	90°	1200lm	1100lm	GAPW-8279012X-WN
					3000K	90°	1300lm	1200lm	GAPW-8309012X-WN
					4000K	90°	1400lm	1300lm	GAPW-8409012X-WN
18 W	20 W	36 V	500 mA	80	2700K	90°	1800lm	1600lm	GAPW-8279018X-WN
					3000K	90°	1900lm	1700lm	GAPW-8309018X-WN
					4000K	90°	2000lm	1800lm	GAPW-8409018X-WN

12 W	14 W	36 V	350 mA	80	2700K	90°	1200lm	1100lm	GAPR-8279012X-BN
					3000K	90°	1300lm	1200lm	GAPR-8309012X-BN
					4000K	90°	1400lm	1300lm	GAPR-8409012X-BN
18 W	20 W	36 V	500 mA	80	2700K	90°	1800lm	1600lm	GAPR-8279018X-BN
					3000K	90°	1900lm	1700lm	GAPR-8309018X-BN
					4000K	90°	2000lm	1800lm	GAPR-8409018X-BN

12 W	14 W	36 V	350 mA	80	2700K	90°	1200lm	1100lm	GAPR-8279012X-WN
					3000K	90°	1300lm	1200lm	GAPR-8309012X-WN
					4000K	90°	1400lm	1300lm	GAPR-8409012X-WN
18 W	20 W	36 V	500 mA	80	2700K	90°	1800lm	1600lm	GAPR-8279018X-WN
					3000K	90°	1900lm	1700lm	GAPR-8309018X-WN
					4000K	90°	2000lm	1800lm	GAPR-8409018X-WN



Code Remark: X=F(ON-OFF) X=P(Phase Dim) X=A(1-10V Dim) X=D(DALI Dim)



**NEKO / GAME450**  
Ceiling Light System



18W CRI80 2700K 3000K 4000K 90° OSRAM UGR < 19 IP40 5 YEAR GUARANTEE CB CE

	LED Power	System Power	LED Voltage	LED Current	CRI	CCT	Beam	LED Output	System Output	Code
 Black	18 W	20 W	36 V	500 mA	80	2700K	90°	1800lm	1700lm	GBSM-8279018X-BN
						3000K	90°	2000lm	1800lm	GBSM-8309018X-BN
						4000K	90°	2200lm	1900lm	GBSM-8409018X-BN
 White	25 W	28 W	36 V	700 mA	80	2700K	90°	2600lm	2300lm	GBSM-8279025X-BN
						3000K	90°	2800lm	2500lm	GBSM-8309025X-BN
						4000K	90°	3000lm	2700lm	GBSM-8409025X-BN

Code Remark: X=F(ON-OFF) X=P(Phase Dim) X=A(1-10V Dim) X=D(DALI Dim)



Black



White



Black



White

LED Power	System Power	LED Voltage	LED Current	CRI	CCT	Beam	LED Output	System Output	Code
18 W	20 W	36 V	500 mA	80	2700K	90°	1800lm	1700lm	GBPW-8279018X-BN
					3000K	90°	2000lm	1800lm	GBPW-8309018X-BN
					4000K	90°	2200lm	1900lm	GBPW-8409018X-BN
25 W	28 W	36 V	700 mA	80	2700K	90°	2600lm	2300lm	GBPW-8279025X-BN
					3000K	90°	2800lm	2500lm	GBPW-8309025X-BN
					4000K	90°	3000lm	2700lm	GBPW-8409025X-BN

LED Power	System Power	LED Voltage	LED Current	CRI	CCT	Beam	LED Output	System Output	Code
18 W	20 W	36 V	500 mA	80	2700K	90°	1800lm	1700lm	GBPW-8279018X-WN
					3000K	90°	2000lm	1800lm	GBPW-8309018X-WN
					4000K	90°	2200lm	1900lm	GBPW-8409018X-WN
25 W	28 W	36 V	700 mA	80	2700K	90°	2600lm	2300lm	GBPW-8279025X-WN
					3000K	90°	2800lm	2500lm	GBPW-8309025X-WN
					4000K	90°	3000lm	2700lm	GBPW-8409025X-WN

LED Power	System Power	LED Voltage	LED Current	CRI	CCT	Beam	LED Output	System Output	Code
18 W	20 W	36 V	500 mA	80	2700K	90°	1800lm	1700lm	GBPR-8279018X-BN
					3000K	90°	2000lm	1800lm	GBPR-8309018X-BN
					4000K	90°	2200lm	1900lm	GBPR-8409018X-BN
25 W	28 W	36 V	700 mA	80	2700K	90°	2600lm	2300lm	GBPR-8279025X-BN
					3000K	90°	2800lm	2500lm	GBPR-8309025X-BN
					4000K	90°	3000lm	2700lm	GBPR-8409025X-BN

LED Power	System Power	LED Voltage	LED Current	CRI	CCT	Beam	LED Output	System Output	Code
18 W	20 W	36 V	500 mA	80	2700K	90°	1800lm	1700lm	GBPR-8279018X-WN
					3000K	90°	2000lm	1800lm	GBPR-8309018X-WN
					4000K	90°	2200lm	1900lm	GBPR-8409018X-WN
25 W	28 W	36 V	700 mA	80	2700K	90°	2600lm	2300lm	GBPR-8279025X-WN
					3000K	90°	2800lm	2500lm	GBPR-8309025X-WN
					4000K	90°	3000lm	2700lm	GBPR-8409025X-WN

Code Remark: X=F(ON-OFF) X=P(Phase Dim) X=A(1-10V Dim) X=D(DALI Dim)

**NEKO / GAME600**  
Ceiling Light System





25W CRI80 2700K  
38W CRI90 3000K  
50W CRI90 4000K

OSRAM UGR < 19  
50,000h@L80B10

IP40

5 YEAR GUARANTEE

CB CE

	LED Power	System Power	LED Voltage	LED Current	CRI	CCT	Beam	LED Output	System Output	Code
 Black	25 W	28 W	36 V	700 mA	80	2700K	90°	2600lm	2300lm	GCSM-8279025X-BN
							3000K	2800lm	2500lm	GCSM-8309025X-BN
							4000K	3000lm	2700lm	GCSM-8409025X-BN
	38 W	42 W	36 V	1050 mA	80	2700K	90°	4100lm	3600lm	GCSM-8279038X-BN
							3000K	4300lm	3800lm	GCSM-8309038X-BN
							4000K	4500lm	4000lm	GCSM-8409038X-BN
	50 W	54 W	36 V	1400 mA	80	2700K	90°	5400lm	4800lm	GCSM-8279050X-BN
							3000K	5600lm	5000lm	GCSM-8309050X-BN
							4000K	5800lm	5200lm	GCSM-8409050X-BN
 White	25 W	28 W	36 V	700 mA	80	2700K	90°	2600lm	2300lm	GCSM-8279025X-WN
							3000K	2800lm	2500lm	GCSM-8309025X-WN
							4000K	3000lm	2700lm	GCSM-8409025X-WN
	38 W	42 W	36 V	1050 mA	80	2700K	90°	4100lm	3600lm	GCSM-8279038X-WN
							3000K	4300lm	3800lm	GCSM-8309038X-WN
							4000K	4500lm	4000lm	GCSM-8409038X-WN
	50 W	54 W	36 V	1400 mA	80	2700K	90°	5400lm	4800lm	GCSM-8279050X-WN
							3000K	5600lm	5000lm	GCSM-8309050X-WN
							4000K	5800lm	5200lm	GCSM-8409050X-WN

Code Remark: X=F(ON-OFF) X=P(Phase Dim) X=A(1-10V Dim) X=D(DALI Dim)

LED Power	System Power	LED Voltage	LED Current	CRI	CCT	Beam	LED Output	System Output	Code
25 W	28 W	36 V	700 mA	80	2700K	90°	2600lm	2300lm	GCPW-8279025X-BN
						3000K	2800lm	2500lm	GCPW-8309025X-BN
						4000K	3000lm	2700lm	GCPW-8409025X-BN
38 W	42 W	36 V	1050 mA	80	2700K	90°	4100lm	3600lm	GCPW-8279038X-BN
						3000K	4300lm	3800lm	GCPW-8309038X-BN
						4000K	4500lm	4000lm	GCPW-8409038X-BN
50 W	54 W	36 V	1400 mA	80	2700K	90°	5400lm	4800lm	GCPW-8279050X-BN
						3000K	5600lm	5000lm	GCPW-8309050X-BN
						4000K	5800lm	5200lm	GCPW-8409050X-BN



Black

LED Power	System Power	LED Voltage	LED Current	CRI	CCT	Beam	LED Output	System Output	Code
25 W	28 W	36 V	700 mA	80	2700K	90°	2600lm	2300lm	GCPW-8279025X-WN
						3000K	2800lm	2500lm	GCPW-8309025X-WN
						4000K	3000lm	2700lm	GCPW-8409025X-WN
38 W	42 W	36 V	1050 mA	80	2700K	90°	4100lm	3600lm	GCPW-8279038X-WN
						3000K	4300lm	3800lm	GCPW-8309038X-WN
						4000K	4500lm	4000lm	GCPW-8409038X-WN
50 W	54 W	36 V	1400 mA	80	2700K	90°	5400lm	4800lm	GCPW-8279050X-WN
						3000K	5600lm	5000lm	GCPW-8309050X-WN
						4000K	5800lm	5200lm	GCPW-8409050X-WN



White

LED Power	System Power	LED Voltage	LED Current	CRI	CCT	Beam	LED Output	System Output	Code
25 W	28 W	36 V	700 mA	80	2700K	90°	2600lm	2300lm	G CPR-8279025X-BN
						3000K	2800lm	2500lm	G CPR-8309025X-BN
						4000K	3000lm	2700lm	G CPR-8409025X-BN
38 W	42 W	36 V	1050 mA	80	2700K	90°	4100lm	3600lm	G CPR-8279038X-BN
						3000K	4300lm	3800lm	G CPR-8309038X-BN
						4000K	4500lm	4000lm	G CPR-8409038X-BN
50 W	54 W	36 V	1400 mA	80	2700K	90°	5400lm	4800lm	G CPR-8279050X-BN
						3000K	5600lm	5000lm	G CPR-8309050X-BN
						4000K	5800lm	5200lm	G CPR-8409050X-BN



Black

LED Power	System Power	LED Voltage	LED Current	CRI	CCT	Beam	LED Output	System Output	Code
25 W	28 W	36 V	700 mA	80	2700K	90°	2600lm	2300lm	G CPR-8279025X-WN
						3000K	2800lm	2500lm	G CPR-8309025X-WN
						4000K	3000lm	2700lm	G CPR-8409025X-WN
38 W	42 W	36 V	1050 mA	80	2700K	90°	4100lm	3600lm	G CPR-8279038X-WN
						3000K	4300lm	3800lm	G CPR-8309038X-WN
						4000K	4500lm	4000lm	G CPR-8409038X-WN
50 W	54 W	36 V	1400 mA	80	2700K	90°	5400lm	4800lm	G CPR-8279050X-WN
						3000K	5600lm	5000lm	G CPR-8309050X-WN
						4000K	5800lm	5200lm	G CPR-8409050X-WN



White

Code Remark: X=F(ON-OFF) X=P(Phase Dim) X=A(1-10V Dim) X=D(DALI Dim)

**NEKO / GAME900**  
Ceiling Light System



65W CRI80 2700K CRI90 3000K 4000K 90° OSRAM UGR < 19 IP40 5 YEAR GUARANTEE CB CE

LED Power	System Power	LED Voltage	LED Current	CRI	CCT	Beam	LED Output	System Output	Code
65 W	68 W	46 V	1400 mA	80	2700K	90°	5700lm	5000lm	GDSM-8279065X-BN
					3000K	90°	6000lm	5200lm	GDSM-8309065X-BN
					4000K	90°	6300lm	5500lm	GDSM-8409065X-BN



Black

65 W	68 W	46 V	1400 mA	80	2700K	90°	5700lm	5000lm	GDSM-8279065X-WN
					3000K	90°	6000lm	5200lm	GDSM-8309065X-WN
					4000K	90°	6300lm	5500lm	GDSM-8409065X-WN



White

Code Remark: X=F(ON-OFF) X=P(Phase Dim) X=A(1-10V Dim) X=D(DALI Dim)



Black

LED Power	System Power	LED Voltage	LED Current	CRI	CCT	Beam	LED Output	System Output	Code
65 W	68 W	46 V	1400 mA	80	2700K	90°	5700lm	5000lm	GDPW-8279065X-BN
					3000K	90°	6000lm	5200lm	GDPW-8309065X-BN
					4000K	90°	6300lm	5500lm	GDPW-8409065X-BN



White

65 W	68 W	46 V	1400 mA	80	2700K	90°	5700lm	5000lm	GDPW-8279065X-WN
					3000K	90°	6000lm	5200lm	GDPW-8309065X-WN
					4000K	90°	6300lm	5500lm	GDPW-8409065X-WN



Black

65 W	68 W	46 V	1400 mA	80	2700K	90°	5700lm	5000lm	GDPR-8279065X-BN
					3000K	90°	6000lm	5200lm	GDPR-8309065X-BN
					4000K	90°	6300lm	5500lm	GDPR-8409065X-BN



White

65 W	68 W	46 V	1400 mA	80	2700K	90°	5700lm	5000lm	GDPR-8279065X-WN
					3000K	90°	6000lm	5200lm	GDPR-8309065X-WN
					4000K	90°	6300lm	5500lm	GDPR-8409065X-WN



Code Remark: X=F(ON-OFF) X=P(Phase Dim) X=A(1-10V Dim) X=D(DALI Dim)



**NEKO / SUGAR350**  
Ceiling Light System



12W CRI80 2700K 3000K 4000K 90° OSRAM 50,000h@L80B10 UGR < 19 IP40 CB CE

	LED Power	System Power	LED Voltage	LED Current	CRI	CCT	Beam	LED Output	System Output	Code
 Black	12 W	14 W	36 V	350 mA	80	2700K	90°	1200lm	1100lm	SASM-8279012X-BB
						3000K	90°	1300lm	1200lm	SASM-8309012X-BB
						4000K	90°	1400lm	1300lm	SASM-8409012X-BB
 Black-Gold	18 W	20 W	36 V	500 mA	80	2700K	90°	1800lm	1600lm	SASM-8279018X-BB
						3000K	90°	1900lm	1700lm	SASM-8309018X-BB
						4000K	90°	2000lm	1800lm	SASM-8409018X-BB
 White	12 W	14 W	36 V	350 mA	80	2700K	90°	1200lm	1100lm	SASM-8279012X-WW
						3000K	90°	1300lm	1200lm	SASM-8309012X-WW
						4000K	90°	1400lm	1300lm	SASM-8409012X-WW
	18 W	20 W	36 V	500 mA	80	2700K	90°	1800lm	1600lm	SASM-8279018X-WW
						3000K	90°	1900lm	1700lm	SASM-8309018X-WW
						4000K	90°	2000lm	1800lm	SASM-8409018X-WW

Code Remark: X=F(ON-OFF) X=P(Phase Dim) X=A(1-10V Dim) X=D(DALI Dim)



Black



Black-Gold



White

LED Power	System Power	LED Voltage	LED Current	CRI	CCT	Beam	LED Output	System Output	Code
12 W	14 W	36 V	350 mA	80	2700K	90°	1200lm	1100lm	SAPW-8279012X-BB
					3000K	90°	1300lm	1200lm	SAPW-8309012X-BB
					4000K	90°	1400lm	1300lm	SAPW-8409012X-BB
18 W	20 W	36 V	500 mA	80	2700K	90°	1800lm	1600lm	SAPW-8279018X-BB
					3000K	90°	1900lm	1700lm	SAPW-8309018X-BB
					4000K	90°	2000lm	1800lm	SAPW-8409018X-BB

LED Power	System Power	LED Voltage	LED Current	CRI	CCT	Beam	LED Output	System Output	Code
12 W	14 W	36 V	350 mA	80	2700K	90°	1200lm	1100lm	SAPW-8279012X-BG
					3000K	90°	1300lm	1200lm	SAPW-8309012X-BG
					4000K	90°	1400lm	1300lm	SAPW-8409012X-BG
18 W	20 W	36 V	500 mA	80	2700K	90°	1800lm	1600lm	SAPW-8279018X-BG
					3000K	90°	1900lm	1700lm	SAPW-8309018X-BG
					4000K	90°	2000lm	1800lm	SAPW-8409018X-BG

LED Power	System Power	LED Voltage	LED Current	CRI	CCT	Beam	LED Output	System Output	Code
12 W	14 W	36 V	350 mA	80	2700K	90°	1200lm	1100lm	SAPW-8279012X-WW
					3000K	90°	1300lm	1200lm	SAPW-8309012X-WW
					4000K	90°	1400lm	1300lm	SAPW-8409012X-WW
18 W	20 W	36 V	500 mA	80	2700K	90°	1800lm	1600lm	SAPW-8279018X-WW
					3000K	90°	1900lm	1700lm	SAPW-8309018X-WW
					4000K	90°	2000lm	1800lm	SAPW-8409018X-WW

Code Remark: X=F(ON-OFF) X=P(Phase Dim) X=A(1-10V Dim) X=D(DALI Dim)



Black

LED Power	System Power	LED Voltage	LED Current	CRI	CCT	Beam	LED Output	System Output	Code	
12 W	14 W	36 V	350 mA	80	2700K	90°	1200lm	1100lm	SAPR-8279012X-BB	
						3000K	90°	1300lm	1200lm	SAPR-8309012X-BB
						4000K	90°	1400lm	1300lm	SAPR-8409012X-BB
18 W	20 W	36 V	500 mA	80	2700K	90°	1800lm	1600lm	SAPR-8279018X-BB	
						3000K	90°	1900lm	1700lm	SAPR-8309018X-BB
						4000K	90°	2000lm	1800lm	SAPR-8409018X-BB



Black-Gold

12 W	14 W	36 V	350 mA	80	2700K	90°	1200lm	1100lm	SAPR-8279012X-BG	
						3000K	90°	1300lm	1200lm	SAPR-8309012X-BG
						4000K	90°	1400lm	1300lm	SAPR-8409012X-BG
18 W	20 W	36 V	500 mA	80	2700K	90°	1800lm	1600lm	SAPR-8279018X-BG	
						3000K	90°	1900lm	1700lm	SAPR-8309018X-BG
						4000K	90°	2000lm	1800lm	SAPR-8409018X-BG



White

12 W	14 W	36 V	350 mA	80	2700K	90°	1200lm	1100lm	SAPR-8279012X-WW	
						3000K	90°	1300lm	1200lm	SAPR-8309012X-WW
						4000K	90°	1400lm	1300lm	SAPR-8409012X-WW
18 W	20 W	36 V	500 mA	80	2700K	90°	1800lm	1600lm	SAPR-8279018X-WW	
						3000K	90°	1900lm	1700lm	SAPR-8309018X-WW
						4000K	90°	2000lm	1800lm	SAPR-8409018X-WW

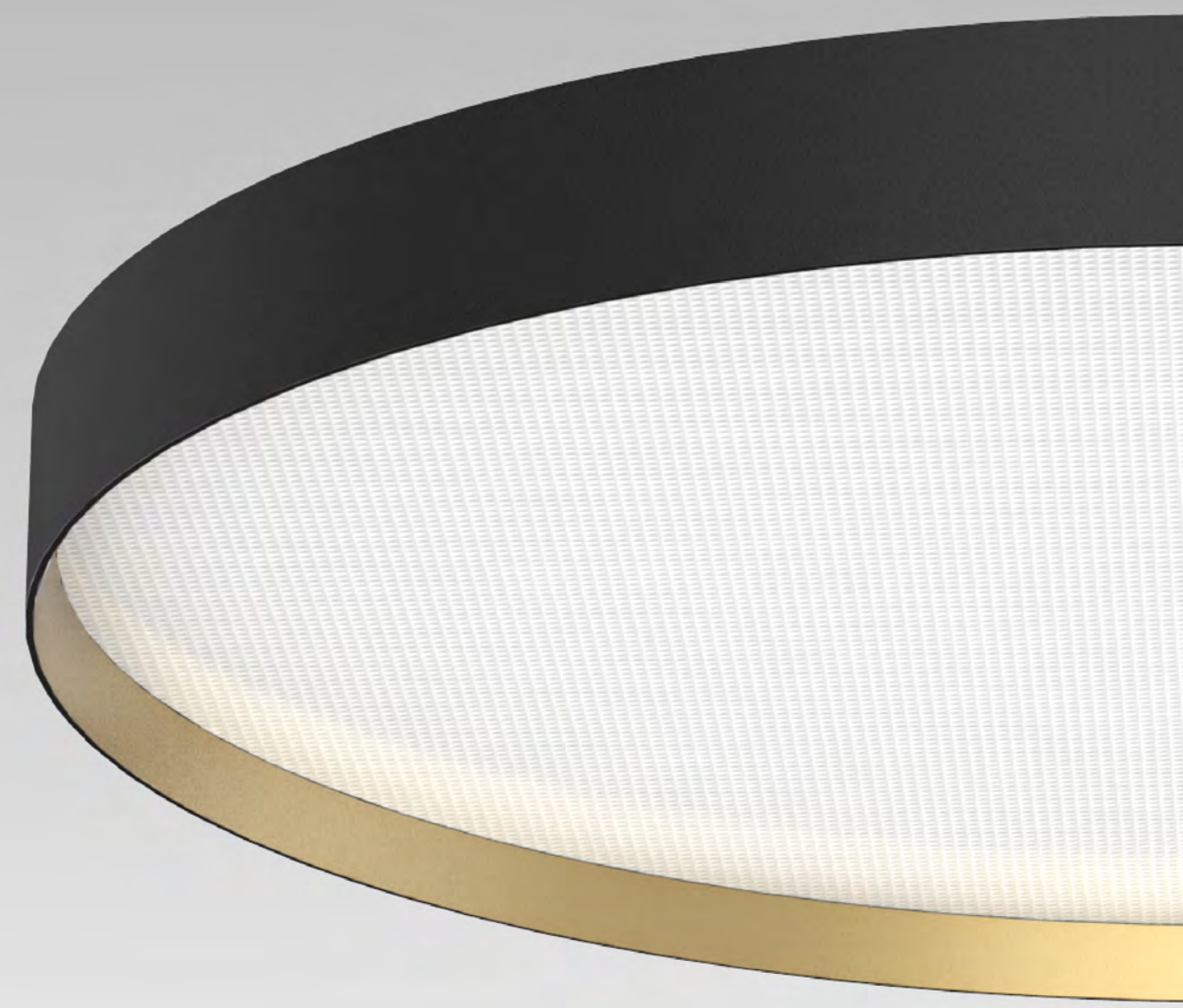

Code Remark: X=F(ON-OFF) X=P(Phase Dim) X=A(1-10V Dim) X=D(DALI Dim)



**NEKO / SUGAR450**  
Ceiling Light System



18W CRI80 2700K 3000K 4000K 90° OSRAM UGR < 19 IP40 5 YEARS GUARANTEE CB CE

	LED Power	System Power	LED Voltage	LED Current	CRI	CCT	Beam	LED Output	System Output	Code
 Black	18 W	20 W	36 V	500 mA	80	2700K	90°	1800lm	1700lm	SBSM-8279018X-BB
						3000K	90°	2000lm	1800lm	SBSM-8309018X-BB
						4000K	90°	2200lm	1900lm	SBSM-8409018X-BB
 Black-Gold	25 W	28 W	36 V	700 mA	80	2700K	90°	2600lm	2300lm	SBSM-8279025X-BB
						3000K	90°	2800lm	2500lm	SBSM-8309025X-BB
						4000K	90°	3000lm	2700lm	SBSM-8409025X-BB
						2700K	90°	1800lm	1700lm	SBSM-8279018X-BG
 White	25 W	28 W	36 V	700 mA	80	3000K	90°	2000lm	1800lm	SBSM-8309018X-BG
						4000K	90°	2200lm	1900lm	SBSM-8409018X-BG
						2700K	90°	2600lm	2300lm	SBSM-8279025X-BG
						3000K	90°	2800lm	2500lm	SBSM-8309025X-BG
	18 W	20 W	36 V	500 mA	80	2700K	90°	1800lm	1700lm	SBSM-8279018X-WW
						3000K	90°	2000lm	1800lm	SBSM-8309018X-WW
						4000K	90°	2200lm	1900lm	SBSM-8409018X-WW
						2700K	90°	2600lm	2300lm	SBSM-8279025X-WW
	25 W	28 W	36 V	700 mA	80	3000K	90°	2800lm	2500lm	SBSM-8309025X-WW
						4000K	90°	3000lm	2700lm	SBSM-8409025X-WW

Code Remark: X=F(ON-OFF) X=P(Phase Dim) X=A(1-10V Dim) X=D(DALI Dim)



Black



Black-Gold



White

LED Power	System Power	LED Voltage	LED Current	CRI	CCT	Beam	LED Output	System Output	Code
18 W	20 W	36 V	500 mA	80	2700K	90°	1800lm	1700lm	SBPW-8279018X-BB
					3000K	90°	2000lm	1800lm	SBPW-8309018X-BB
					4000K	90°	2200lm	1900lm	SBPW-8409018X-BB
25 W	28 W	36 V	700 mA	80	2700K	90°	2600lm	2300lm	SBPW-8279025X-BB
					3000K	90°	2800lm	2500lm	SBPW-8309025X-BB
					4000K	90°	3000lm	2700lm	SBPW-8409025X-BB

LED Power	System Power	LED Voltage	LED Current	CRI	CCT	Beam	LED Output	System Output	Code
18 W	20 W	36 V	500 mA	80	2700K	90°	1800lm	1700lm	SBPW-8279018X-BG
					3000K	90°	2000lm	1800lm	SBPW-8309018X-BG
					4000K	90°	2200lm	1900lm	SBPW-8409018X-BG
25 W	28 W	36 V	700 mA	80	2700K	90°	2600lm	2300lm	SBPW-8279025X-BG
					3000K	90°	2800lm	2500lm	SBPW-8309025X-BG
					4000K	90°	3000lm	2700lm	SBPW-8409025X-BG

LED Power	System Power	LED Voltage	LED Current	CRI	CCT	Beam	LED Output	System Output	Code
18 W	20 W	36 V	500 mA	80	2700K	90°	1800lm	1700lm	SBPW-8279018X-WW
					3000K	90°	2000lm	1800lm	SBPW-8309018X-WW
					4000K	90°	2200lm	1900lm	SBPW-8409018X-WW
25 W	28 W	36 V	700 mA	80	2700K	90°	2600lm	2300lm	SBPW-8279025X-WW
					3000K	90°	2800lm	2500lm	SBPW-8309025X-WW
					4000K	90°	3000lm	2700lm	SBPW-8409025X-WW

Code Remark: X=F(ON-OFF) X=P(Phase Dim) X=A(1-10V Dim) X=D(DALI Dim)





Black

LED Power	System Power	LED Voltage	LED Current	CRI	CCT	Beam	LED Output	System Output	Code
18 W	20 W	36 V	500 mA	80	2700K	90°	1800lm	1700lm	SBPR-8279018X-BB
					3000K	90°	2000lm	1800lm	SBPR-8309018X-BB
					4000K	90°	2200lm	1900lm	SBPR-8409018X-BB
25 W	28 W	36 V	700 mA	80	2700K	90°	2600lm	2300lm	SBPR-8279025X-BB
					3000K	90°	2800lm	2500lm	SBPR-8309025X-BB
					4000K	90°	3000lm	2700lm	SBPR-8409025X-BB



Black-Gold

LED Power	System Power	LED Voltage	LED Current	CRI	CCT	Beam	LED Output	System Output	Code
18 W	20 W	36 V	500 mA	80	2700K	90°	1800lm	1700lm	SBPR-8279018X-BG
					3000K	90°	2000lm	1800lm	SBPR-8309018X-BG
					4000K	90°	2200lm	1900lm	SBPR-8409018X-BG
25 W	28 W	36 V	700 mA	80	2700K	90°	2600lm	2300lm	SBPR-8279025X-BG
					3000K	90°	2800lm	2500lm	SBPR-8309025X-BG
					4000K	90°	3000lm	2700lm	SBPR-8409025X-BG



White

LED Power	System Power	LED Voltage	LED Current	CRI	CCT	Beam	LED Output	System Output	Code
18 W	20 W	36 V	500 mA	80	2700K	90°	1800lm	1700lm	SBPR-8279018X-WW
					3000K	90°	2000lm	1800lm	SBPR-8309018X-WW
					4000K	90°	2200lm	1900lm	SBPR-8409018X-WW
25 W	28 W	36 V	700 mA	80	2700K	90°	2600lm	2300lm	SBPR-8279025X-WW
					3000K	90°	2800lm	2500lm	SBPR-8309025X-WW
					4000K	90°	3000lm	2700lm	SBPR-8409025X-WW

Code Remark: X=F(ON-OFF) X=P(Phase Dim) X=A(1-10V Dim) X=D(DALI Dim)



**NEKO / SUGAR600**  
Ceiling Light System



25W CRI80 2700K  
38W CRI90 3000K  
50W CRI90 4000K

OSRAM  
50,000h@L80B10

UGR < 19

IP40

5 YEARS GUARANTEE

CB CE

	LED Power	System Power	LED Voltage	LED Current	CRI	CCT	Beam	LED Output	System Output	Code
Black	25 W	28 W	36 V	700 mA	80	2700K	90°	2600lm	2300lm	SCSM-8279025X-BB
						3000K	90°	2800lm	2500lm	SCSM-8309025X-BB
						4000K	90°	3000lm	2700lm	SCSM-8409025X-BB
	38 W	42 W	36 V	1050 mA	80	2700K	90°	4100lm	3600lm	SCSM-8279038X-BB
						3000K	90°	4300lm	3800lm	SCSM-8309038X-BB
						4000K	90°	4500lm	4000lm	SCSM-8409038X-BB
	50 W	54 W	36 V	1400 mA	80	2700K	90°	5400lm	4800lm	SCSM-8279050X-BB
						3000K	90°	5600lm	5000lm	SCSM-8309050X-BB
						4000K	90°	5800lm	5200lm	SCSM-8409050X-BB
Black-Gold	25 W	28 W	36 V	700 mA	80	2700K	90°	2600lm	2300lm	SCSM-8279025X-BG
						3000K	90°	2800lm	2500lm	SCSM-8309025X-BG
						4000K	90°	3000lm	2700lm	SCSM-8409025X-BG
	38 W	42 W	36 V	1050 mA	80	2700K	90°	4100lm	3600lm	SCSM-8279038X-BG
						3000K	90°	4300lm	3800lm	SCSM-8309038X-BG
						4000K	90°	4500lm	4000lm	SCSM-8409038X-BG
	50 W	54 W	36 V	1400 mA	80	2700K	90°	5400lm	4800lm	SCSM-8279050X-BG
						3000K	90°	5600lm	5000lm	SCSM-8309050X-BG
						4000K	90°	5800lm	5200lm	SCSM-8409050X-BG
White	25 W	28 W	36 V	700 mA	80	2700K	90°	2600lm	2300lm	SCSM-8279025X-WW
						3000K	90°	2800lm	2500lm	SCSM-8309025X-WW
						4000K	90°	3000lm	2700lm	SCSM-8409025X-WW
	38 W	42 W	36 V	1050 mA	80	2700K	90°	4100lm	3600lm	SCSM-8279038X-WW
						3000K	90°	4300lm	3800lm	SCSM-8309038X-WW
						4000K	90°	4500lm	4000lm	SCSM-8409038X-WW
	50 W	54 W	36 V	1400 mA	80	2700K	90°	5400lm	4800lm	SCSM-8279050X-WW
						3000K	90°	5600lm	5000lm	SCSM-8309050X-WW
						4000K	90°	5800lm	5200lm	SCSM-8409050X-WW

Code Remark: X=F(ON-OFF) X=P(Phase Dim) X=A(1-10V Dim) X=D(DALI Dim)

LED Power	System Power	LED Voltage	LED Current	CRI	CCT	Beam	LED Output	System Output	Code
25 W	28 W	36 V	700 mA	80	2700K	90°	2600lm	2300lm	SCPW-8279025X-BB
					3000K	90°	2800lm	2500lm	SCPW-8309025X-BB
					4000K	90°	3000lm	2700lm	SCPW-8409025X-BB
38 W	42 W	36 V	1050 mA	80	2700K	90°	4100lm	3600lm	SCPW-8279038X-BB
					3000K	90°	4300lm	3800lm	SCPW-8309038X-BB
					4000K	90°	4500lm	4000lm	SCPW-8409038X-BB
50 W	54 W	36 V	1400 mA	80	2700K	90°	5400lm	4800lm	SCPW-8279050X-BB
					3000K	90°	5600lm	5000lm	SCPW-8309050X-BB
					4000K	90°	5800lm	5200lm	SCPW-8409050X-BB



LED Power	System Power	LED Voltage	LED Current	CRI	CCT	Beam	LED Output	System Output	Code
25 W	28 W	36 V	700 mA	80	2700K	90°	2600lm	2300lm	SCPW-8279025X-BG
					3000K	90°	2800lm	2500lm	SCPW-8309025X-BG
					4000K	90°	3000lm	2700lm	SCPW-8409025X-BG
38 W	42 W	36 V	1050 mA	80	2700K	90°	4100lm	3600lm	SCPW-8279038X-BG
					3000K	90°	4300lm	3800lm	SCPW-8309038X-BG
					4000K	90°	4500lm	4000lm	SCPW-8409038X-BG
50 W	54 W	36 V	1400 mA	80	2700K	90°	5400lm	4800lm	SCPW-8279050X-BG
					3000K	90°	5600lm	5000lm	SCPW-8309050X-BG
					4000K	90°	5800lm	5200lm	SCPW-8409050X-BG



LED Power	System Power	LED Voltage	LED Current	CRI	CCT	Beam	LED Output	System Output	Code
25 W	28 W	36 V	700 mA	80	2700K	90°	2600lm	2300lm	SCPW-8279025X-WW
					3000K	90°	2800lm	2500lm	SCPW-8309025X-WW
					4000K	90°	3000lm	2700lm	SCPW-8409025X-WW
38 W	42 W	36 V	1050 mA	80	2700K	90°	4100lm	3600lm	SCPW-8279038X-WW
					3000K	90°	4300lm	3800lm	SCPW-8309038X-WW
					4000K	90°	4500lm	4000lm	SCPW-8409038X-WW
50 W	54 W	36 V	1400 mA	80	2700K	90°	5400lm	4800lm	SCPW-8279050X-WW
					3000K	90°	5600lm	5000lm	SCPW-8309050X-WW
					4000K	90°	5800lm	5200lm	SCPW-8409050X-WW



Code Remark: X=F(ON-OFF) X=P(Phase Dim) X=A(1-10V Dim) X=D(DALI Dim)



Black

LED Power	System Power	LED Voltage	LED Current	CRI	CCT	Beam	LED Output	System Output	Code
25 W	28 W	36 V	700 mA	80	2700K	90°	2600lm	2300lm	SCPR-8279025X-BB
						90°	2800lm	2500lm	SCPR-8309025X-BB
						90°	3000lm	2700lm	SCPR-8409025X-BB
38 W	42 W	36 V	1050 mA	80	2700K	90°	4100lm	3600lm	SCPR-8279038X-BB
						90°	4300lm	3800lm	SCPR-8309038X-BB
						90°	4500lm	4000lm	SCPR-8409038X-BB
50 W	54 W	36 V	1400 mA	80	2700K	90°	5400lm	4800lm	SCPR-8279050X-BB
						90°	5600lm	5000lm	SCPR-8309050X-BB
						90°	5800lm	5200lm	SCPR-8409050X-BB



Black-Gold

25 W	28 W	36 V	700 mA	80	2700K	90°	2600lm	2300lm	SCPR-8279025X-BG
						90°	2800lm	2500lm	SCPR-8309025X-BG
						90°	3000lm	2700lm	SCPR-8409025X-BG
38 W	42 W	36 V	1050 mA	80	2700K	90°	4100lm	3600lm	SCPR-8279038X-BG
						90°	4300lm	3800lm	SCPR-8309038X-BG
						90°	4500lm	4000lm	SCPR-8409038X-BG
50 W	54 W	36 V	1400 mA	80	2700K	90°	5400lm	4800lm	SCPR-8279050X-BG
						90°	5600lm	5000lm	SCPR-8309050X-BG
						90°	5800lm	5200lm	SCPR-8409050X-BG



White

25 W	28 W	36 V	700 mA	80	2700K	90°	2600lm	2300lm	SCPR-8279025X-WW
						90°	2800lm	2500lm	SCPR-8309025X-WW
						90°	3000lm	2700lm	SCPR-8409025X-WW
38 W	42 W	36 V	1050 mA	80	2700K	90°	4100lm	3600lm	SCPR-8279038X-WW
						90°	4300lm	3800lm	SCPR-8309038X-WW
						90°	4500lm	4000lm	SCPR-8409038X-WW
50 W	54 W	36 V	1400 mA	80	2700K	90°	5400lm	4800lm	SCPR-8279050X-WW
						90°	5600lm	5000lm	SCPR-8309050X-WW
						90°	5800lm	5200lm	SCPR-8409050X-WW

Code Remark: X=F(ON-OFF) X=P(Phase Dim) X=A(1-10V Dim) X=D(DALI Dim)

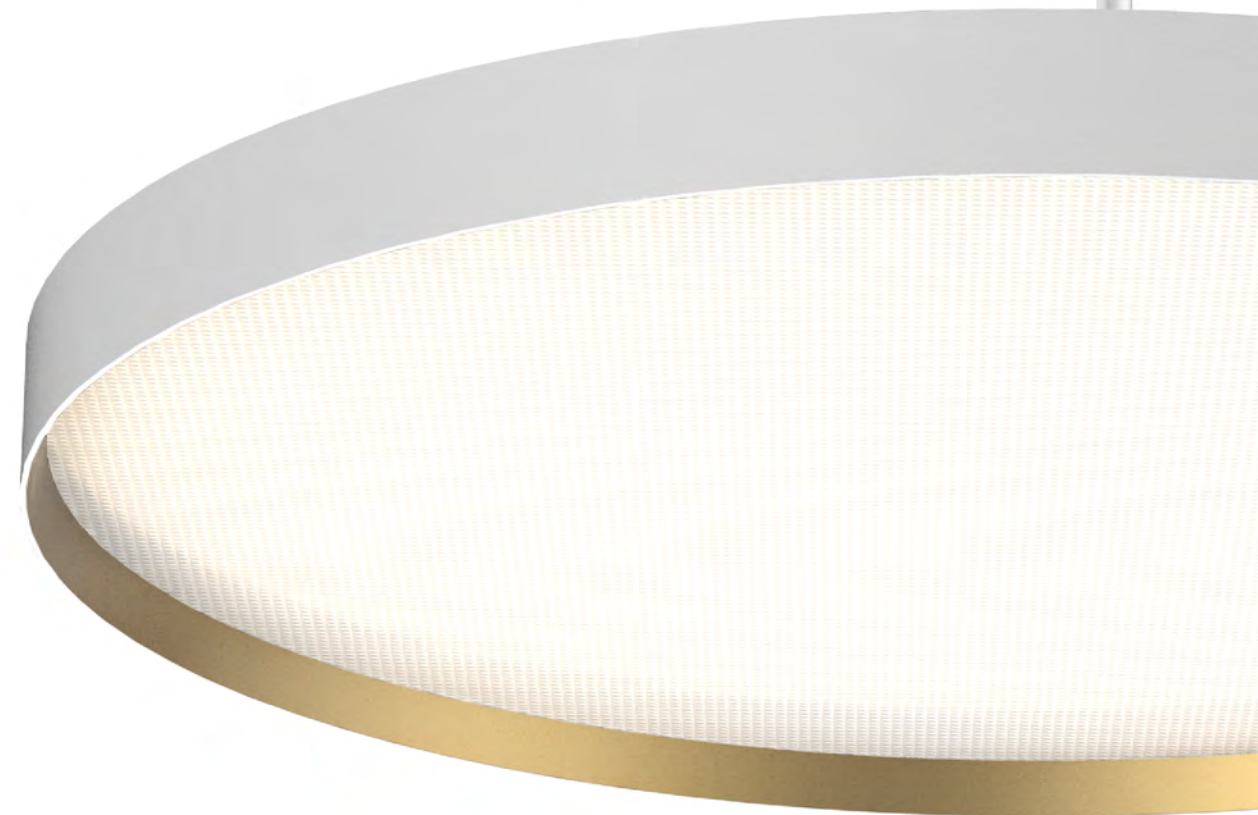



**NEKO / SUGAR900**  
Ceiling Light System



65W CRI180 2700K CRI190 3000K 4000K 90° OSRAM 50,000h@L80B10 UGR < 19 IP40 5 YEAR GUARANTEE CB CE

LED Power	System Power	LED Voltage	LED Current	CRI	CCT	Beam	LED Output	System Output	Code
65 W	68 W	46 V	1400 mA	80	2700K	90°	5700lm	5000lm	SDSM-8279065X-BB
					3000K	90°	6000lm	5200lm	SDSM-8309065X-BB
					4000K	90°	6300lm	5500lm	SDSM-8409065X-BB
-----									
65 W	68 W	46 V	1400 mA	80	2700K	90°	5700lm	5000lm	SDSM-8279065X-BG
					3000K	90°	6000lm	5200lm	SDSM-8309065X-BG
					4000K	90°	6300lm	5500lm	SDSM-8409065X-BG
-----									
65 W	68 W	46 V	1400 mA	80	2700K	90°	5700lm	5000lm	SDSM-8279065X-WW
					3000K	90°	6000lm	5200lm	SDSM-8309065X-WW
					4000K	90°	6300lm	5500lm	SDSM-8409065X-WW
Code Remark: X=F(ON-OFF) X=P(Phase Dim) X=A(1-10V Dim) X=D(DALI Dim)									



Black



Black-Gold



White

LED Power	System Power	LED Voltage	LED Current	CRI	CCT	Beam	LED Output	System Output	Code
65 W	68 W	46 V	1400 mA	80	2700K	90°	5700lm	5000lm	SDPW-8279065X-BB
					3000K	90°	6000lm	5200lm	SDPW-8309065X-BB
					4000K	90°	6300lm	5500lm	SDPW-8409065X-BB

65 W	68 W	46 V	1400 mA	80	2700K	90°	5700lm	5000lm	SDPW-8279065X-BG
					3000K	90°	6000lm	5200lm	SDPW-8309065X-BG
					4000K	90°	6300lm	5500lm	SDPW-8409065X-BG

65 W	68 W	46 V	1400 mA	80	2700K	90°	5700lm	5000lm	SDPW-8279065X-WW
					3000K	90°	6000lm	5200lm	SDPW-8309065X-WW
					4000K	90°	6300lm	5500lm	SDPW-8409065X-WW

Code Remark: X=F(ON-OFF) X=P(Phase Dim) X=A(1-10V Dim) X=D(DALI Dim)



Black

LED Power	System Power	LED Voltage	LED Current	CRI	CCT	Beam	LED Output	System Output	Code
65 W	68 W	46 V	1400 mA	80	2700K	90°	5700lm	5000lm	SDPR-8279065X-BB
					3000K	90°	6000lm	5200lm	SDPR-8309065X-BB
					4000K	90°	6300lm	5500lm	SDPR-8409065X-BB



Black-Gold

65 W	68 W	46 V	1400 mA	80	2700K	90°	5700lm	5000lm	SDPR-8279065X-BG
					3000K	90°	6000lm	5200lm	SDPR-8309065X-BG
					4000K	90°	6300lm	5500lm	SDPR-8409065X-BG



White

65 W	68 W	46 V	1400 mA	80	2700K	90°	5700lm	5000lm	SDPR-8279065X-WW
					3000K	90°	6000lm	5200lm	SDPR-8309065X-WW
					4000K	90°	6300lm	5500lm	SDPR-8409065X-WW

Code Remark: X=F(ON-OFF) X=P(Phase Dim) X=A(1-10V Dim) X=D(DALI Dim)





PURE

PURE Art	PURE S	PURE M
15W 950-1000lm	15W 1200-1300lm 21W 1600-1700lm	28W 2700-2900lm

Narrow, medium and wide beam angles are available for different lighting applications

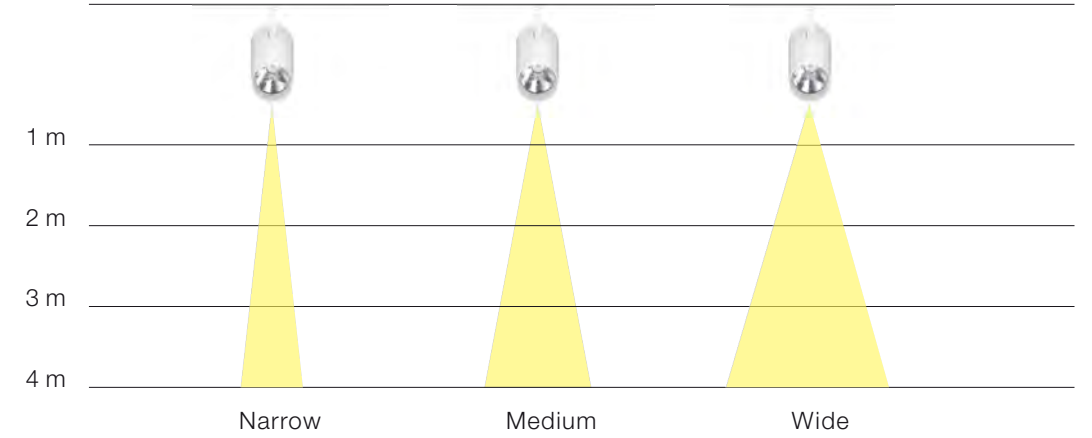



NEKO / PURE Art  
LED Tracklight



15W CRI90 CRI80 2700K 3000K 4000K 18° 24° 36° CITIZEN Micro-Hemiconductors 50,000h@L80B10 UGR < 19 IP20 5 YEAR GUARANTEE CB CE



LED Power	System Power	LED Voltage	LED Current	CRI	CCT	Beam	LED Output	System Output	Code						
13 W	15 W	36 V	350 mA	90	2700K	18°	1100lm	900lm	PUA2- 9271815X-WB						
						24°	1100lm	900lm	PUA2- 9272415X-WB						
						36°	1100lm	900lm	PUA2- 9273615X-WB						
						3000K	18°	1200lm	950lm	PUA2- 9301815X-WB					
							24°	1200lm	950lm	PUA2- 9302415X-WB					
							36°	1200lm	950lm	PUA2- 9303615X-WB					
						4000K	18°	1300lm	1000lm	PUA2- 9401815X-WB					
							24°	1300lm	1000lm	PUA2- 9402415X-WB					
							36°	1300lm	1000lm	PUA2- 9403615X-WB					
						13 W	15 W	36 V	350 mA	90	2700K	18°	1100lm	900lm	PUA2- 9271815X-BB
												24°	1100lm	900lm	PUA2- 9272415X-BB
												36°	1100lm	900lm	PUA2- 9273615X-BB
3000K	18°	1200lm	950lm	PUA2- 9301815X-BB											
	24°	1200lm	950lm	PUA2- 9302415X-BB											
	36°	1200lm	950lm	PUA2- 9303615X-BB											
4000K	18°	1300lm	1000lm	PUA2- 9401815X-BB											
	24°	1300lm	1000lm	PUA2- 9402415X-BB											
	36°	1300lm	1000lm	PUA2- 9403615X-BB											

Code Remark X=F(ON-OFF) X=P(Phase Dim)

Optional accessory



Honeycomb

Code for PUA2-930 1815X-WB with Honeycomb  
PUA2-930 1815X-WB-H



**NEKO / PURE S**  
LED Tracklight



21W 15W CRI90 CRI80 2700K 3000K 4000K 15° 25° 30° CITIZEN 50,000h@L80B10 UGR < 19 IP20 5 YEAR GUARANTEE CB CE

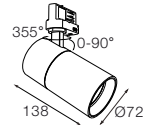

LED Power	System Power	LED Voltage	LED Current	CRI	CCT	Beam	LED Output	System Output	Code						
13 W	15 W	36 V	350 mA	90	2700K	15°	1400lm	1100lm	PUS1-9271515X-WB						
						25°	1400lm	1100lm	PUS1-9272515X-WB						
						30°	1400lm	1100lm	PUS1-9273015X-WB						
						3000K	15°	1500lm	1200lm	PUS1-9301515X-WB					
							25°	1500lm	1200lm	PUS1-9302515X-WB					
							30°	1500lm	1200lm	PUS1-9303015X-WB					
						3000K	15°	1600lm	1300lm	PUS1-9401515X-WB					
							25°	1600lm	1300lm	PUS1-9402515X-WB					
							30°	1600lm	1300lm	PUS1-9403015X-WB					
						18 W	21 W	36 V	500 mA	90	2700K	15°	1900lm	1500lm	PUS2-9271521X-WB
												25°	1900lm	1500lm	PUS2-9272521X-WB
												30°	1900lm	1500lm	PUS2-9273021X-WB
3000K	15°	2000lm	1600lm	PUS2-9301521X-WB											
	25°	2000lm	1600lm	PUS2-9302521X-WB											
	30°	2000lm	1600lm	PUS2-9303021X-WB											
4000K	15°	2100lm	1700lm	PUS2-9401521X-WB											
	25°	2100lm	1700lm	PUS2-9402521X-WB											
	30°	2100lm	1700lm	PUS2-9403021X-WB											



LED Power	System Power	LED Voltage	LED Current	CRI	CCT	Beam	LED Output	System Output	Code						
13 W	15 W	36 V	350 mA	90	2700K	15°	1400lm	1100lm	PUS1-9271515X-BB						
						25°	1400lm	1100lm	PUS1-9272515X-BB						
						30°	1400lm	1100lm	PUS1-9273015X-BB						
						3000K	15°	1500lm	1200lm	PUS1-9301515X-BB					
							25°	1500lm	1200lm	PUS1-9302515X-BB					
							30°	1500lm	1200lm	PUS1-9303015X-BB					
						4000K	15°	1600lm	1300lm	PUS1-9401515X-BB					
							25°	1600lm	1300lm	PUS1-9402515X-BB					
							30°	1600lm	1300lm	PUS1-9403015X-BB					
						18 W	21 W	36 V	500 mA	90	2700K	15°	1900lm	1500lm	PUS2-9271521X-BB
												25°	1900lm	1500lm	PUS2-9272521X-BB
												30°	1900lm	1500lm	PUS2-9273021X-BB
3000K	15°	2000lm	1600lm	PUS2-9301521X-BB											
	25°	2000lm	1600lm	PUS2-9302521X-BB											
	30°	2000lm	1600lm	PUS2-9303021X-BB											
4000K	15°	2100lm	1700lm	PUS2-9401521X-BB											
	25°	2100lm	1700lm	PUS2-9402521X-BB											
	30°	2100lm	1700lm	PUS2-9403021X-BB											

Code Remark: X=F(ON-OFF) X=P(Phase Dim)

Optional accessory

 Code for PUS1-930 1515X-WB with Honeycomb  
PUS1-930 1515X-WB-H  
Honeycomb

21W 15W CRI90 CRI80 2700K 3000K 4000K 15° 25° 30° CITIZEN 50,000h@L80B10 GLOBAL 5 UGR < 19 IP20 DALI 5 YEAR GUARANTEE CB CE

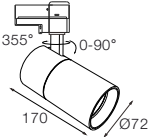

LED Power	System Power	LED Voltage	LED Current	CRI	CCT	Beam	LED Output	System Output	Code						
13 W	15 W	36 V	350 mA	90	2700K	15°	1400lm	1100lm	PUS1-9271515D-WB						
						25°	1400lm	1100lm	PUS1-9272515D-WB						
						30°	1400lm	1100lm	PUS1-9273015D-WB						
						3000K	15°	1500lm	1200lm	PUS1-9301515D-WB					
							25°	1500lm	1200lm	PUS1-9302515D-WB					
							30°	1500lm	1200lm	PUS1-9303015D-WB					
						4000K	15°	1600lm	1300lm	PUS1-9401515D-WB					
							25°	1600lm	1300lm	PUS1-9402515D-WB					
							30°	1600lm	1300lm	PUS1-9403015D-WB					
						18 W	21 W	36 V	500 mA	90	2700K	15°	1900lm	1500lm	PUS2-9271521D-WB
												25°	1900lm	1500lm	PUS2-9272521D-WB
												30°	1900lm	1500lm	PUS2-9273021D-WB
3000K	15°	2000lm	1600lm	PUS2-9301521D-WB											
	25°	2000lm	1600lm	PUS2-9302521D-WB											
	30°	2000lm	1600lm	PUS2-9303021D-WB											
4000K	15°	2100lm	1700lm	PUS2-9401521D-WB											
	25°	2100lm	1700lm	PUS2-9402521D-WB											
	30°	2100lm	1700lm	PUS2-9403021D-WB											



LED Power	System Power	LED Voltage	LED Current	CRI	CCT	Beam	LED Output	System Output	Code						
13 W	15 W	36 V	350 mA	90	2700K	15°	1400lm	1100lm	PUS1-9271515D-BB						
						25°	1400lm	1100lm	PUS1-9272515D-BB						
						30°	1400lm	1100lm	PUS1-9273015D-BB						
						3000K	15°	1500lm	1200lm	PUS1-9301515D-BB					
							25°	1500lm	1200lm	PUS1-9302515D-BB					
							30°	1500lm	1200lm	PUS1-9303015D-BB					
						4000K	15°	1600lm	1300lm	PUS1-9401515D-BB					
							25°	1600lm	1300lm	PUS1-9402515D-BB					
							30°	1600lm	1300lm	PUS1-9403015D-BB					
						18 W	21 W	36 V	500 mA	90	2700K	15°	1900lm	1500lm	PUS2-9271521D-BB
												25°	1900lm	1500lm	PUS2-9272521D-BB
												30°	1900lm	1500lm	PUS2-9273021D-BB
3000K	15°	2000lm	1600lm	PUS2-9301521D-BB											
	25°	2000lm	1600lm	PUS2-9302521D-BB											
	30°	2000lm	1600lm	PUS2-9303021D-BB											
4000K	15°	2100lm	1700lm	PUS2-9401521D-BB											
	25°	2100lm	1700lm	PUS2-9402521D-BB											
	30°	2100lm	1700lm	PUS2-9403021D-BB											

Code Remark: DALI Dim Version

Optional accessory

 Code for PUS1-930 1515D-WB with Honeycomb  
PUS1-930 1515D-WB-H  
Honeycomb



**NEKO / PURE M**  
LED Tracklight

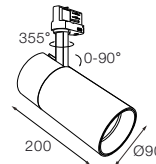

28W CRI90 CRI80 2700K 3000K 4000K 18° 30° 45° CITIZEN 50,000h@L80B10 UGR < 19 IP20 5 YEAR GUARANTEE CB CE



LED Power	System Power	LED Voltage	LED Current	CRI	CCT	Beam	LED Output	System Output	Code						
25 W	28 W	36 V	700 mA	90	2700K	18°	3200lm	2500lm	PUM1-9271828X-WB						
						30°	3200lm	2500lm	PUM1-9273028X-WB						
						45°	3200lm	2500lm	PUM1-9274528X-WB						
						3000K	18°	3400lm	2700lm	PUM1-9301828X-WB					
							30°	3400lm	2700lm	PUM1-9303028X-WB					
							45°	3400lm	2700lm	PUM1-9304528X-WB					
						4000K	18°	3600lm	2900lm	PUM1-9401828X-WB					
							30°	3600lm	2900lm	PUM1-9403028X-WB					
							45°	3600lm	2900lm	PUM1-9404528X-WB					
						25 W	28 W	36 V	700 mA	90	2700K	18°	3200lm	2500lm	PUM1-9271828X-WB
												30°	3200lm	2500lm	PUM1-9273028X-WB
												45°	3200lm	2500lm	PUM1-9274528X-WB
3000K	18°	3400lm	2700lm	PUM1-9301828X-WB											
	30°	3400lm	2700lm	PUM1-9303028X-WB											
	45°	3400lm	2700lm	PUM1-9304528X-WB											
4000K	18°	3600lm	2900lm	PUM1-9401828X-WB											
	30°	3600lm	2900lm	PUM1-9403028X-WB											
	45°	3600lm	2900lm	PUM1-9404528X-WB											

Code Remark: X=F(ON-OFF) X=P(Phase Dim)

Optional accessory



Honeycomb

Code for PUM1-930 1828X-WB with Honeycomb  
PUM1-930 1828X-WB-H

28W CRI90 CRI80 2700K 3000K 4000K 18° 30° 45° CITIZEN 50,000h@L80B10 GLOBAL UGR < 19 IP20 DALI 5 YEAR GUARANTEE CB CE

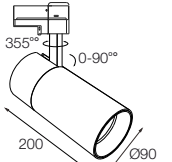

LED Power	System Power	LED Voltage	LED Current	CRI	CCT	Beam	LED Output	System Output	Code	
25 W	28 W	36 V	700 mA	90	2700K	18°	3200lm	2500lm	PUM1-9271828D-WB	
						30°	3200lm	2500lm	PUM1-9273028D-WB	
						45°	3200lm	2500lm	PUM1-9274528D-WB	
						3000K	18°	3400lm	2700lm	PUM1-9301828D-WB
							30°	3400lm	2700lm	PUM1-9303028D-WB
							45°	3400lm	2700lm	PUM1-9304528D-WB
						4000K	18°	3600lm	2900lm	PUM1-9401828D-WB
							30°	3600lm	2900lm	PUM1-9403028D-WB
							45°	3600lm	2900lm	PUM1-9404528D-WB

25 W	28 W	36 V	700 mA	90	2700K	18°	3200lm	2500lm	PUM1-9271828D-WB	
						30°	3200lm	2500lm	PUM1-9273028D-WB	
						45°	3200lm	2500lm	PUM1-9274528D-WB	
						3000K	18°	3400lm	2700lm	PUM1-9301828D-WB
							30°	3400lm	2700lm	PUM1-9303028D-WB
							45°	3400lm	2700lm	PUM1-9304528D-WB
						4000K	18°	3600lm	2900lm	PUM1-9401828D-WB
							30°	3600lm	2900lm	PUM1-9403028D-WB
							45°	3600lm	2900lm	PUM1-9404528D-WB

Code Remark: DALI Dim Version

Optional accessory



Honeycomb

Code for PUM1-930 1828D-WB with Honeycomb  
PUM1-930 1828D-WB-H





**NEKO / PURE-C**  
Ceiling Mounted PURE S Tracklight



21W CRI90 2700K 15° CITIZEN UGR < 19 IP 20 30 138 072



LED Power	System Power	LED Voltage	LED Current	CRI	CCT	Beam	LED Output	System Output	Code						
13 W	15 W	36 V	350 mA	90	2700K	15°	1400lm	1100lm	PUC1-9271515X-WB						
						25°	1400lm	1100lm	PUC1-9272515X-WB						
						30°	1400lm	1100lm	PUC1-9273015X-WB						
						3000K	15°	1500lm	1200lm	PUC1-9301515X-WB					
							25°	1500lm	1200lm	PUC1-9302515X-WB					
							30°	1500lm	1200lm	PUC1-9303015X-WB					
						4000K	15°	1600lm	1300lm	PUC1-9401515X-WB					
							25°	1600lm	1300lm	PUC1-9402515X-WB					
							30°	1600lm	1300lm	PUC1-9403015X-WB					
						18 W	21 W	36 V	500 mA	90	2700K	15°	1900lm	1500lm	PUC2-9271521X-WB
												25°	1900lm	1500lm	PUC2-9272521X-WB
												30°	1900lm	1500lm	PUC2-9273021X-WB
3000K	15°	2000lm	1600lm	PUC2-9301521X-WB											
	25°	2000lm	1600lm	PUC2-9302521X-WB											
	30°	2000lm	1600lm	PUC2-9303021X-WB											
4000K	15°	2100lm	1700lm	PUC2-9401521X-WB											
	25°	2100lm	1700lm	PUC2-9402521X-WB											
	30°	2100lm	1700lm	PUC2-9403021X-WB											
13 W	15 W	36 V	350 mA	90	2700K							15°	1400lm	1100lm	PUC1-9271515X-BB
												25°	1400lm	1100lm	PUC1-9272515X-BB
												30°	1400lm	1100lm	PUC1-9273015X-BB
						3000K	15°	1500lm	1200lm	PUC1-9301515X-BB					
							25°	1500lm	1200lm	PUC1-9302515X-BB					
							30°	1500lm	1200lm	PUC1-9303015X-BB					
						4000K	15°	1600lm	1300lm	PUC1-9401515X-BB					
							25°	1600lm	1300lm	PUC1-9402515X-BB					
							30°	1600lm	1300lm	PUC1-9403015X-BB					
						18 W	21 W	36 V	500 mA	90	2700K	15°	1900lm	1500lm	PUC2-9271521X-BB
												25°	1900lm	1500lm	PUC2-9272521X-BB
												30°	1900lm	1500lm	PUC2-9273021X-BB
3000K	15°	2000lm	1600lm	PUC2-9301521X-BB											
	25°	2000lm	1600lm	PUC2-9302521X-BB											
	30°	2000lm	1600lm	PUC2-9303021X-BB											
4000K	15°	2100lm	1700lm	PUC2-9401521X-BB											
	25°	2100lm	1700lm	PUC2-9402521X-BB											
	30°	2100lm	1700lm	PUC2-9403021X-BB											

Code Remark: X=F(ON-OFF) X=P(Phase Dim)

Optional accessory



Code for PUC1-930 1515X-WB with Honeycomb  
PUC1-930 1515X-WB-H

Honeycomb

Ceiling Mounted



**NEKO / FOCUS**  
LED Tracklight



**FOCUS S** 15W 1000-1100lm  
28W 1900-2100lm

**FOCUS M** 42W 2700-2900lm



**FOCUS**

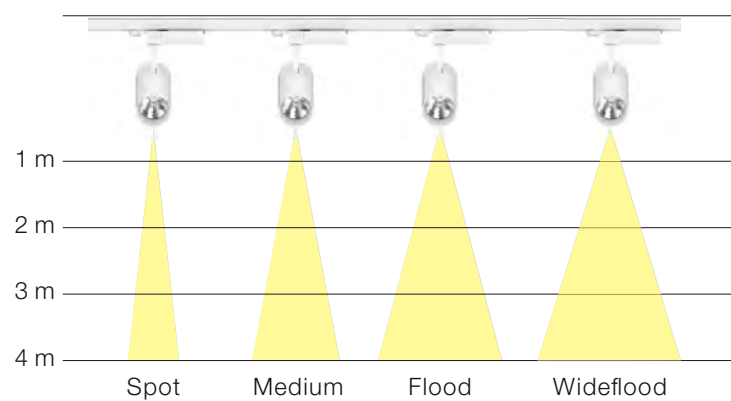



**NEKO / FOCUS S**  
LED Tracklight

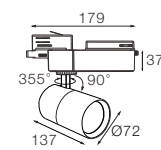

28W CRI90 2700K 18° CITIZEN 50,000h@L80B10 GLOBAL GUARANTEE UGR < 19 IP20 CB CE



LED Power	System Power	LED Voltage	LED Current	CRI	CCT	Beam	LED Output	System Output	Code						
13 W	15 W	36 V	350 mA	90	2700K	12°	1300lm	950lm	FOS1-9271215X-WB						
						25°	1300lm	950lm	FOS1-9272515X-WB						
						40°	1300lm	950lm	FOS1-9274015X-WB						
						3000K	12°	1400lm	1000lm	FOS1-9301215X-WB					
							25°	1400lm	1000lm	FOS1-9302515X-WB					
							40°	1400lm	1000lm	FOS1-9304015X-WB					
						4000K	12°	1500lm	1100lm	FOS1-9401215X-WB					
							25°	1500lm	1100lm	FOS1-9402515X-WB					
							40°	1500lm	1100lm	FOS1-9404015X-WB					
						25 W	28 W	36 V	700 mA	90	2700K	18°	2300lm	1800lm	FOS2-9271828X-WB
												25°	2300lm	1800lm	FOS2-9272528X-WB
												40°	2300lm	1800lm	FOS2-9274028X-WB
3000K	18°	2500lm	1900lm	FOS2-9301828X-WB											
	25°	2500lm	1900lm	FOS2-9302528X-WB											
	40°	2500lm	1900lm	FOS2-9304028X-WB											
4000K	18°	2700lm	2100lm	FOS2-9401828X-WB											
	25°	2700lm	2100lm	FOS2-9402528X-WB											
	40°	2700lm	2100lm	FOS2-9404028X-WB											
13 W	15 W	36 V	350 mA	90	2700K							12°	1300lm	950lm	FOS1-9271215X-BB
												25°	1300lm	950lm	FOS1-9272515X-BB
												40°	1300lm	950lm	FOS1-9274015X-BB
						3000K	12°	1400lm	1000lm	FOS1-9301215X-BB					
							25°	1400lm	1000lm	FOS1-9302515X-BB					
							40°	1400lm	1000lm	FOS1-9304015X-BB					
						4000K	12°	1500lm	1100lm	FOS1-9401215X-BB					
							25°	1500lm	1100lm	FOS1-9402515X-BB					
							40°	1500lm	1100lm	FOS1-9404015X-BB					
						25 W	28 W	36 V	700 mA	90	2700K	18°	2300lm	1800lm	FOS2-9271828X-BB
												25°	2300lm	1800lm	FOS2-9272528X-BB
												40°	2300lm	1800lm	FOS2-9274028X-BB
3000K	18°	2500lm	1900lm	FOS2-9301828X-BB											
	25°	2500lm	1900lm	FOS2-9302528X-BB											
	40°	2500lm	1900lm	FOS2-9304028X-BB											
4000K	18°	2700lm	2100lm	FOS2-9401828X-BB											
	25°	2700lm	2100lm	FOS2-9402528X-BB											
	40°	2700lm	2100lm	FOS2-9404028X-BB											

Code Remark: X=F(ON-OFF) X=P(Phase Dim)

Optional accessory

 Code for FOS1-930 1815X-WB with Honeycomb  
FOS1-930 1815X-WB-H  
Honeycomb





NEKO / FOCUS M  
LED Tracklight

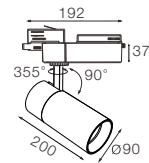

42W CRI90 2700K 18° CITIZEN GLOBAL UGR < 19 IP 20 CB CE  
CRI80 3000K 25° 50,000h@L80B10  
4000K 35° 50°



LED Power	System Power	LED Voltage	LED Current	CRI	CCT	Beam	LED Output	System Output	Code	
38 W	42 W	36 V	1050 mA	90	2700K	18°	3400lm	2500lm	FOM1-9271842X-WB	
						25°	3400lm	2500lm	FOM1-9272542X-WB	
						35°	3400lm	2500lm	FOM1-9273542X-WB	
						50°	3400lm	2500lm	FOM1-9275042X-WB	
						3000K	18°	3600lm	2700lm	FOM1-9301842X-WB
							25°	3600lm	2700lm	FOM1-9302542X-WB
							35°	3600lm	2700lm	FOM1-9303542X-WB
							50°	3600lm	2700lm	FOM1-9305042X-WB
						4000K	18°	3800lm	2900lm	FOM1-9401842X-WB
							25°	3800lm	2900lm	FOM1-9402542X-WB
							35°	3800lm	2900lm	FOM1-9403542X-WB
							50°	3800lm	2900lm	FOM1-9405042X-WB
38 W	42 W	36 V	1050 mA	90	2700K	18°	3400lm	2500lm	FOM1-9271842X-BB	
						25°	3400lm	2500lm	FOM1-9272542X-BB	
						35°	3400lm	2500lm	FOM1-9273542X-BB	
						50°	3400lm	2500lm	FOM1-9275042X-BB	
						3000K	18°	3600lm	2700lm	FOM1-9301842X-BB
							25°	3600lm	2700lm	FOM1-9302542X-BB
							35°	3600lm	2700lm	FOM1-9303542X-BB
							50°	3600lm	2700lm	FOM1-9305042X-BB
						4000K	18°	3800lm	2900lm	FOM1-9401842X-BB
							25°	3800lm	2900lm	FOM1-9402542X-BB
							35°	3800lm	2900lm	FOM1-9403542X-BB
							50°	3800lm	2900lm	FOM1-9405042X-BB

Code Remark: X=F(ON-OFF) X=P(Phase Dim)

Optional accessory



Honeycomb

Code for PUM1-930 1828X-WB with Honeycomb  
PUM1-930 1828X-WB-H



Beam



BO S 15W 1050-1150lm



BO M 28W 2400-2600lm



BO L 42W 3400-3600lm

BO ist eine vielseitige Strahler-Familie für Stromschienen, die sich durch ein schlichtes und hochwertiges Design auszeichnet. Ihre formalen Eigenschaften entsprechen dabei gleichermaßen den technischen Anforderungen wie den gestalterischen Potentialen der LED-Technik. So ist der von klassischen Leuchtenformen inspirierte Leuchtenkopf dank raffinierter Kühlkörperausbildung äusserst kompakt und reduziert gestaltet. Die separate Adapterbox garantiert derweil beste Bedingungen für das Betriebsgerät und einfaches Handling der Leuchte. Sowohl die Dreh- als auch die Schwenkbarkeit der Leuchte werden ausschliesslich über den im Leuchtenkopf integrierten Arm gelöst. So liegt die Adapterbox stets parallel zur Stromschiene, wodurch sich die Leuchte sehr zurückhaltend und harmonisch in ihre Umgebung einfügt. Drei verschiedene Leuchtengrössen und diverses optisches Zubehör ermöglichen zudem einen flexiblen Einsatz bei allen Beleuchtungsaufgaben, bei denen einzigartiges Design und modernste LED-Lichttechnik gefragt sind.

BO is a versatile spotlight family for track lighting that stands out through unique and simple design. Its visual features correlate both with the technical requirements and the formal potentials of LED technology. The spotlight's head is inspired by classical lamp shades and – due to an elaborated heat dissipation concept – it has a very reduced and compact shape. The separated adaptor box ensures the best environmental conditions for the driver and also an easy handling of the luminaire. As both the rotation and the pivoting are solely performed by the cantilever integrated into the spotlight's head, the adaptor box will always stay parallel to the lighting track. Thus the track light blends in its architectural environment in a very smooth and even manner. Three different sizes and a wide range of optical accessories complement the spotlight family and make it suitable for all kinds of lighting tasks that require high-quality design and state-of-the-art LED technology.



Oliver Königs





NEKO / BOS  
LED Tracklight

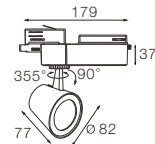

15W CRI90 CRI80 2700K 3000K 4000K 12° 22° 40° CITIZEN 50,000h@L80B10 GLOBAL UGR < 19 IP20 5 YEAR GUARANTEE CB CE C UL US



LED Power	System Power	LED Voltage	LED Current	CRI	CCT	Beam	LED Output	System Output	Code	
13 W	15 W	36 V	350 mA	90	2700K	12°	1300lm	950lm	BOS1-9271215X-WB	
						22°	1300lm	950lm	BOS1-9272215X-WB	
						40°	1300lm	950lm	BOS1-9274015X-WB	
						3000K	12°	1400lm	1050lm	BOS1-9301215X-WB
							22°	1400lm	1050lm	BOS1-9302215X-WB
							40°	1400lm	1050lm	BOS1-9304015X-WB
						4000K	12°	1500lm	1150lm	BOS1-9401215X-WB
							22°	1500lm	1150lm	BOS1-9402215X-WB
							40°	1500lm	1150lm	BOS1-9404015X-WB



13 W	15 W	36 V	350 mA	90	2700K	12°	1300lm	950lm	BOS1-9271215X-BB	
						22°	1300lm	950lm	BOS1-9272215X-BB	
						40°	1300lm	950lm	BOS1-9274015X-BB	
						3000K	12°	1400lm	1050lm	BOS1-9301215X-BB
							22°	1400lm	1050lm	BOS1-9302215X-BB
							40°	1400lm	1050lm	BOS1-9304015X-BB
						4000K	12°	1500lm	1150lm	BOS1-9401215X-BB
							22°	1500lm	1150lm	BOS1-9402215X-BB
							40°	1500lm	1150lm	BOS1-9404015X-BB

Code Remark: X=F(ON-OFF) X=P(Phase Dim)

Optional accessory



Honeycomb

Code for BOS1-9302215X-WB with Honeycomb  
BOS1-9302215X-WB-H





**NEKO / BOM**  
LED Tracklight

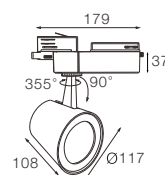

28W CRI90 CRI80 2700K 3000K 4000K 12° 22° 40° CITIZEN 50,000h@L80B10 GLOBAL UGR < 19 IP 20 5 YEAR GUARANTEE CB CE C UL US



LED Power	System Power	LED Voltage	LED Current	CRI	CCT	Beam	LED Output	System Output	Code	
25 W	28 W	36 V	700 mA	90	2700K	12°	2800lm	2200lm	BOM1-9271228X-WB	
						22°	2800lm	2200lm	BOM1-9272228X-WB	
						40°	2800lm	2200lm	BOM1-9274028X-WB	
						3000K	12°	3000lm	2400lm	BOM1-9301228X-WB
							22°	3000lm	2400lm	BOM1-9302228X-WB
							40°	3000lm	2400lm	BOM1-9304028X-WB
						4000K	12°	3200lm	2600lm	BOM1-9401228X-WB
							22°	3200lm	2600lm	BOM1-9402228X-WB
							40°	3200lm	2600lm	BOM1-9404028X-WB



25 W	28 W	36 V	700 mA	90	2700K	12°	2800lm	2200lm	BOM1-9271228X-BB	
						22°	2800lm	2200lm	BOM1-9272228X-BB	
						40°	2800lm	2200lm	BOM1-9274028X-BB	
						3000K	12°	3000lm	2400lm	BOM1-9301228X-BB
							22°	3000lm	2400lm	BOM1-9302228X-BB
							40°	3000lm	2400lm	BOM1-9304028X-BB
						4000K	12°	3200lm	2600lm	BOM1-9401228X-BB
							22°	3200lm	2600lm	BOM1-9402228X-BB
							40°	3200lm	2600lm	BOM1-9404028X-BB

Code Remark: X=F(ON-OFF) X=P(Phase Dim)

Optional accessory



Honeycomb

Code for BOM1-9302228X-WB with Honeycomb  
BOM1-9302228X-WB-H



**NEKO / BOL**  
LED Tracklight

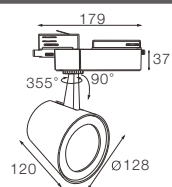

42W CRI90 CRI80 2700K 3000K 4000K 12° 22° 40° 60° CITIZEN 50,000h@L80B10 GLOBAL 5 UGR < 19 IP 20 5 YEARS GUARANTEE CB CE C UL US



LED Power	System Power	LED Voltage	LED Current	CRI	CCT	Beam	LED Output	System Output	Code	
38 W	42 W	36 V	1050 mA	90	2700K	12°	4000lm	3200lm	BOL1-9271242X-WB	
						22°	4000lm	3200lm	BOL1-9272242X-WB	
						40°	4000lm	3200lm	BOL1-9274042X-WB	
						60°	4000lm	3200lm	BOL1-9276042X-WB	
						3000K	12°	4200lm	3400lm	BOL1-9301242X-WB
							22°	4200lm	3400lm	BOL1-9302242X-WB
							40°	4200lm	3400lm	BOL1-9304042X-WB
							60°	4200lm	3400lm	BOL1-9306042X-WB
						4000K	12°	4500lm	3600lm	BOL1-9401242X-WB
							22°	4500lm	3600lm	BOL1-9402242X-WB
							40°	4500lm	3600lm	BOL1-9404042X-WB
							60°	4500lm	3600lm	BOL1-9406042X-WB



38 W	42 W	36 V	1050 mA	90	2700K	12°	4000lm	3200lm	BOL1-9271242X-BB	
						22°	4000lm	3200lm	BOL1-9272242X-BB	
						40°	4000lm	3200lm	BOL1-9274042X-BB	
						60°	4000lm	3200lm	BOL1-9276042X-BB	
						3000K	12°	4200lm	3400lm	BOL1-9301242X-BB
							22°	4200lm	3400lm	BOL1-9302242X-BB
							40°	4200lm	3400lm	BOL1-9304042X-BB
							60°	4200lm	3400lm	BOL1-9306042X-BB
						4000K	12°	4500lm	3600lm	BOL1-9401242X-BB
							22°	4500lm	3600lm	BOL1-9402242X-BB
							40°	4500lm	3600lm	BOL1-9404042X-BB
							60°	4500lm	3600lm	BOL1-9406042X-BB

Code Remark X=F(ON-OFF) X=P(Phase Dim)

Optional accessory



Honeycomb

Code for BOL1-9302242X-WB with Honeycomb  
BOL1-9302242X-WB-H





- Headquarters
- German Office
- Factory
- N. America
- Shanghai Office
- Distributor

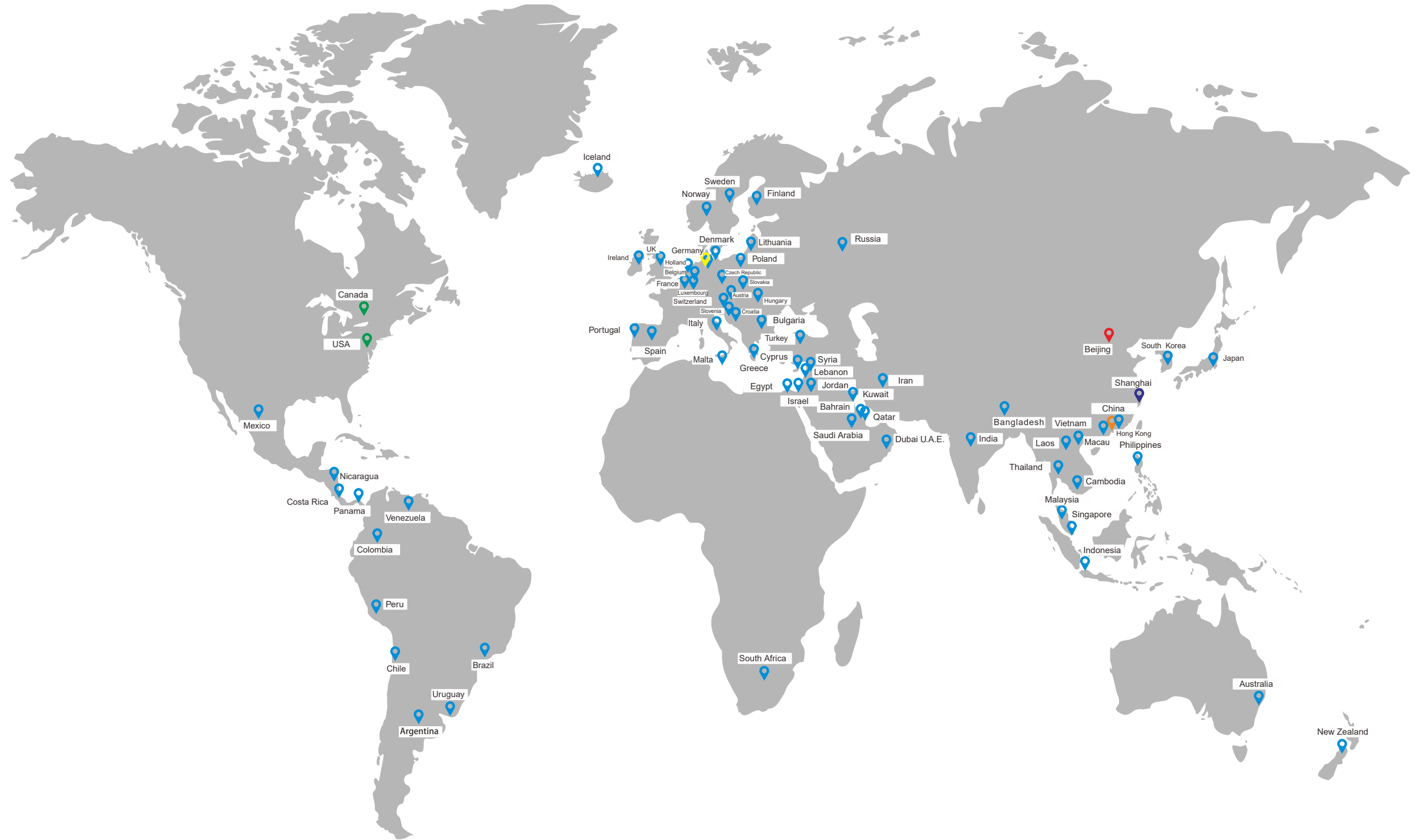

**NEKO LIGHTING AG**  
**Switzerland Headquarters**  
 Kreuzstrasse 2, CH-8008 Zürich, Switzerland  
 Tel: +41 44 451 80 15  
 sales@nekolighting.com  
 www.nekolighting.com

**NEKO LIGHTING GmbH**  
**German Office**  
 Lange Reihe 170, 59071 Hamm, Germany  
 Tel: +49 2381 8770960  
 sales@nekolighting.de  
 www.nekolighting.de

**NEKO LIGHTING LTD.**  
**China Factory**  
 Shenzhen, P.R.China | P.C.: 518132  
 Tel: +86 755 3669 7712  
 Melina@nekolighting.com

**NEKO LIGHTING INC.**  
**N. America**  
 3025 Bates Road, Montreal, QC H3S 2W6, Canada  
 357 Cortland Street, Belleville, NJ 07109, USA  
 +1 855 LED NEKO (533 6356)

**NEKO Shanghai Office**  
 No. 248, 5588 Lane, San Lu Road, Minhang District,  
 Shanghai, P.R.China  
 Tel: +86 136 1190 0658  
 Kevin@nekolighting.com

**NEKO Beijing Office**  
 Room 218, Huaxi Loft,  
 5th Da Yang Fang Road,  
 Chaoyang District,  
 Beijing, China.  
 Tel: +86 173 2681 1100  
 sales@nekolighting.com





A series of horizontal dotted lines for writing, spanning the width of the page.