

BENTON FAMILY LED

APPLICATION

BOLLARD | LIGHT COLUMN



The quality of life ...



BENTON 1



BENTON 2



BENTON 3



BENTON 4

EN | FR | FI





BENTON FAMILY

Benton Bollards



IP65 · CLASS I · CE



This stylish cylindrical bollard is designed for downlight distribution with optimal visual comfort though excellent glare control design. Designed to complement the Benton light column, these bollards feature bright and square light output and four sided distribution. Excellent optical focusing, as well as high efficiency and long service life. Main applications are for providing wide spread ground illumination on driveways, pathways & squares.

The luminaire rated as CLASS I with integral driver. Colour temperature 2700K, 3000K and 4000K, LED CRI >80 and life time 50,000 Hours.

Aluminium die-cast with color powder coating. Extruded aluminium body. LED optical reflector. Stainless steel fasteners in grade 316. Durable silicone rubber gasket and clear toughened glass. Powder coating with high corrosion resistance with chemical chromatinized protection.

Le design innovant des bornes BENTON garantit un haut niveau d'efficacité et un confort visuel optimal sans causer d'éblouissement. Conçues pour être coordonnées avec les candélabres BENTON. Ces bornes ont distribution latérale de la lumière par les quatre faces carrées et une excellente optique focale qui procure une bonne performance. Elles sont idéales pour les rues piétonnes, les circulations, et les quartiers.

Luminaire de Classe I avec driver intégré. Températures de couleur 2700K, 3000K et 4000K. Durée de vie des LED de 50000 heures et IRC>80.

Fût en aluminium extrudé peint en poudre, laquée époxy avec protection chromatique offrant une haute résistance à la corrosion. Optique LED avec réflecteur. Joint d'étanchéité en silicone élastomère et diffuseur en verre trempé renforcé. Vis inox de degré 316.

Tyylikään Benton sarjan valaisimilla luodaan tehokas, korkeatasoinen valaistus ilman ylöspäin suuntautuvaa hajavaloa. "Dark sky" optiikka. Benton valaisimilla on korkean hyötysuhteen lisäksi hyvin kontrolloitu pyörähdyssymmetrinen alaspäin suunnattu valonjako. Benton sarjaan kuuluu myös pylväsvalaisin.

Valaisimien suojausluokka on I ja se toteutetaan sisäisellä LED driverilla. Värieläpötilat 2700K, 3000K ja 4000K, LED CRI >80, elinikä > 50000h L80/B10, MacAdam 3 SDCM

Runko on suulake puristettua korroosion kestävää alumiinia. Ruuvit on ruostumattomaa haponkestävää terästä AISI 316. Valaisimissa on silikoni tiivisteet sekä kirkas karkaistu suojalasi. Polyesteri pulveripolttoaalattu runko.



Ordering guide sample Échantillon de Guide de commande Valaisimen yksilöinti

BE-10001 - W30 - A10291

Model No	Colour	Accessory
----------	--------	-----------

Colour Temperature
 W27 - Warm 2700K
 W30 - Warm white 3000K
 W40 - Neutral white 4000K



Series	Model No.	Lamp	Power	Lumen	EEC	Colour	Beam	Diameter	Weight	Accessory No.
BENTON 1	BE-10001	1 COB	20 W	1094 lm	A+	W27 / W30 / W40	76°	160	7.0 kg.	A10291
BENTON 2	BE-10011	1 COB	26 W	1642 lm	A++	W27 / W30 / W40	65°	225	9.5 kg.	A10491



BENTON 1

BENTON 2

ACCESSORY



A10291, A10491
Anchor bolt

BE-10001

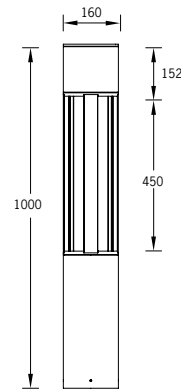

BE-10011

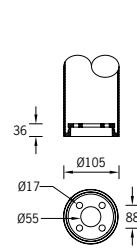
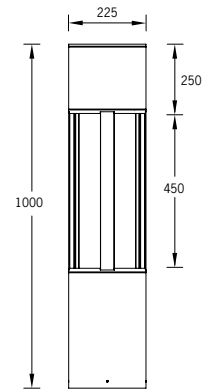

Mounting detail
Instructions de montage
Asennusohje

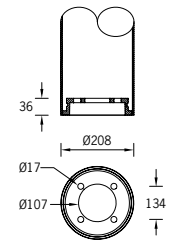

Mounting detail
Instructions de montage
Asennusohje

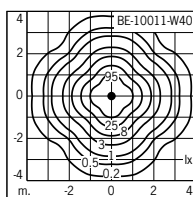
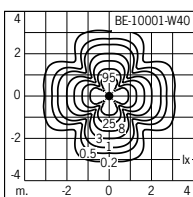



Benton Light column luminaire

IP65 · CLASS I · CE



Stylish cylindrical columns with downlight distribution with optimal visual comfort though excellent glare control design. Designed to complement the Benton bollard, these columns feature square profile and four sided distribution which is perfect in optical focusing and high efficiency for a long service lifetime of performance. Main applications are for providing wide spread ground illumination for pedestrian precincts, building surroundings, shopping centers & squares where dark sky concerns are required.

The luminaire rated as CLASS I with integral driver. Colour temperature 2700K, 3000K and 4000K, LED CRI >80 and life time 50,000 Hours.

Aluminium die-cast with color powder coating. Extruded aluminium column. LED optical reflector. Stainless steel fasteners in grade 316. Durable silicone rubber gasket and clear toughened glass. Powder coating with high corrosion resistance with chemical chromated protection.

A20691 and A20791 Root mount kit accessory for installation.

Les colonnes lumineuses cylindriques BENTON sont conçues pour la distribution optimisée de la lumière qui procure un confort visuel optimal grâce à une grande maîtrise de l'éblouissement. Complément de gamme avec la borne BENTON.

Ces luminaires ont une distribution latérale de la lumière par les quatre faces carrées et une excellente optique focale qui procure une bonne performance de la LED. Principales applications pour les rues piétonnes, les circulations, les centres commerciaux et les quartiers. Adapté à la norme sur la pollution lumineuse.

Le luminaire de classe I avec driver intégré. Les températures de couleurs disponibles : 2700K, 3000K et 4000K, LED CRI > 80 et la durée de vie de 50000 heures.

Luminaire en fonte d'aluminium peint à la poudre. Colonne en aluminium extrudé, laquée à haute résistance à la corrosion avec protection chromatique chimique. Optique LED avec réflecteur. Vis en acier inoxydable de degré 316. Joint d'étanchéité en silicone élastomère et diffuseur en verre trempé renforcé.

Tyylikään Benton sarjan valaisimilla luodaan tehokas, korkeatasoinen valaistus ilman ylöspäin suuntautuvaa hajavaloa. "Dark sky" optiikka. Benton valaisimilla on korkean hyötysuhteen lisäksi hyvin kontrolloitu pyörähdys-symmetrinen alaspäin suunnattu valonjako. Benton sarjaan kuuluu myös pylväsvalaisin. Tyypillisiä käyttökohteita on rakennusten ympäristöt, ostoskeskukset, aukiot sekä alueet missä tarvitaan dark sky optiikkaa. Benton sarjaan kuuluu myös pollari valaisin.

Valaisimien suojausluokka on I ja se toimitetaan sisäisellä LED driverilla. Värilämpötilat 2700K, 3000K ja 4000K, LED CRI >80, elinikä > 50000h L80/B10, MacAdam 3 SDCM

Valaisimen runko on suulake puristettua korroosion kestävää alumiinia. Ruuvit on ruostumatonta haponkestävää terästä AISI 316. Valaisimissa on silikoni tiivisteet sekä kirkas karkaistu suojalasi. Polyesteri pulveripolttoaalattu runko.

Lisätarvikkeena pylväsjalustat A20691 sekä A20791



Ordering guide sample Échantillon de Guide de commande Valaisimen yksilöinti

BE-20001 - W30 - A20791



Colour Temperature
 W27 - Warm 2700K
 W30 - Warm white 3000K
 W40 - Neutral white 4000K



Series	Model No.	Lamp	Power	Lumen	EEC	Colour	Beam	Diameter	Height	Weight	Accessory No.
BENTON 3	BE-20001	1 COB	40 W	2489 lm	A++	W27 / W30 / W40	65°	225	4500	33.0 kg.	A20791
BENTON 4	BE-20011	1 COB	20 W	1102 lm	A++	W27 / W30 / W40	76°	160	3500	20.7 kg.	A20691

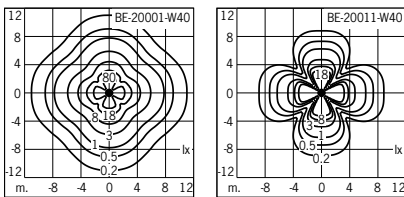

BENTON 3

BENTON 4

ACCESSORY



A20691, A20791
 Root mount kit

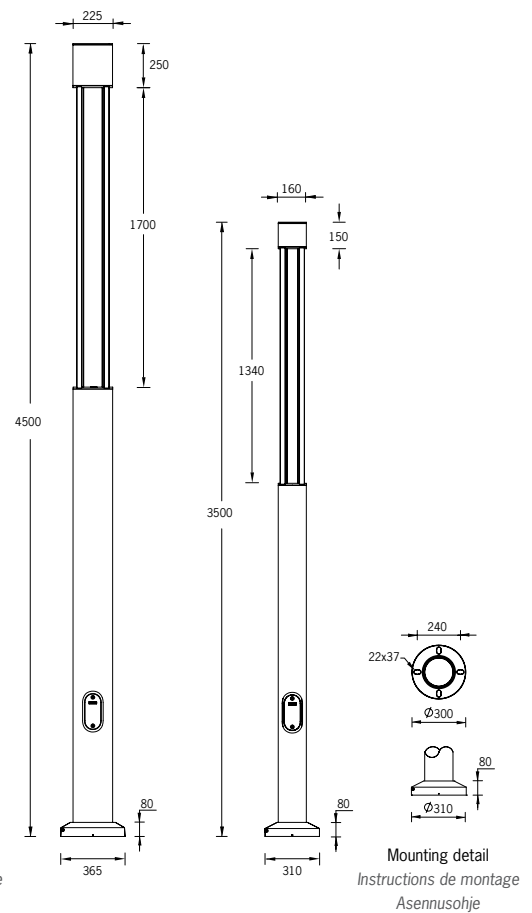
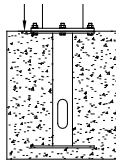



www.ligman.com/product/benton

Efficient Lighting Systems has distributors
in each capital city in Australia and New Zealand.
To find your local distributor visit
www.elslighting.com.au



EFFICIENT LIGHTING SYSTEMS
39 TINNING ST BRUNSWICK VIC 3056
PO BOX 5084 MORELAND WEST VIC 3055
PHONE: 03 9222 5522
FAX: 03 9222 5521
EMAIL: info@elslighting.com.au
www.elslighting.com.au