

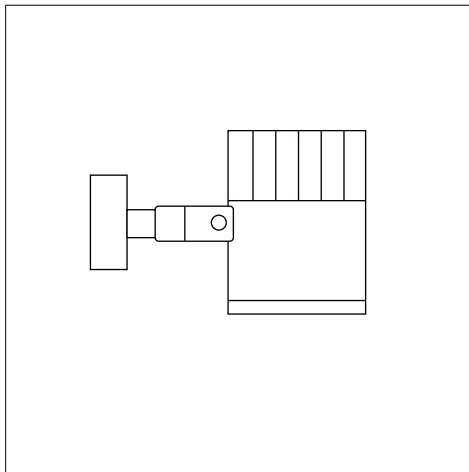



**LOVO**



### Der Alleskönner

Lovo ist das kleine Kraftpaket unter den Flutern. Ob als Wand- oder Deckenleuchte, zu Anstrahlzwecken auf einem Poller, mit Erdspiess im Garten oder Wandausleger an der Fassade - Lovo setzt jede Situation ins rechte Licht.

### The all-rounder

Lovo is the little powerhouse among the floodlights. Whether wall or ceiling-mounted, on a bollard for effect, stuck into the ground in the garden on a stick or on a wall bracket on the façade - Lovo creates the right light for every situation.

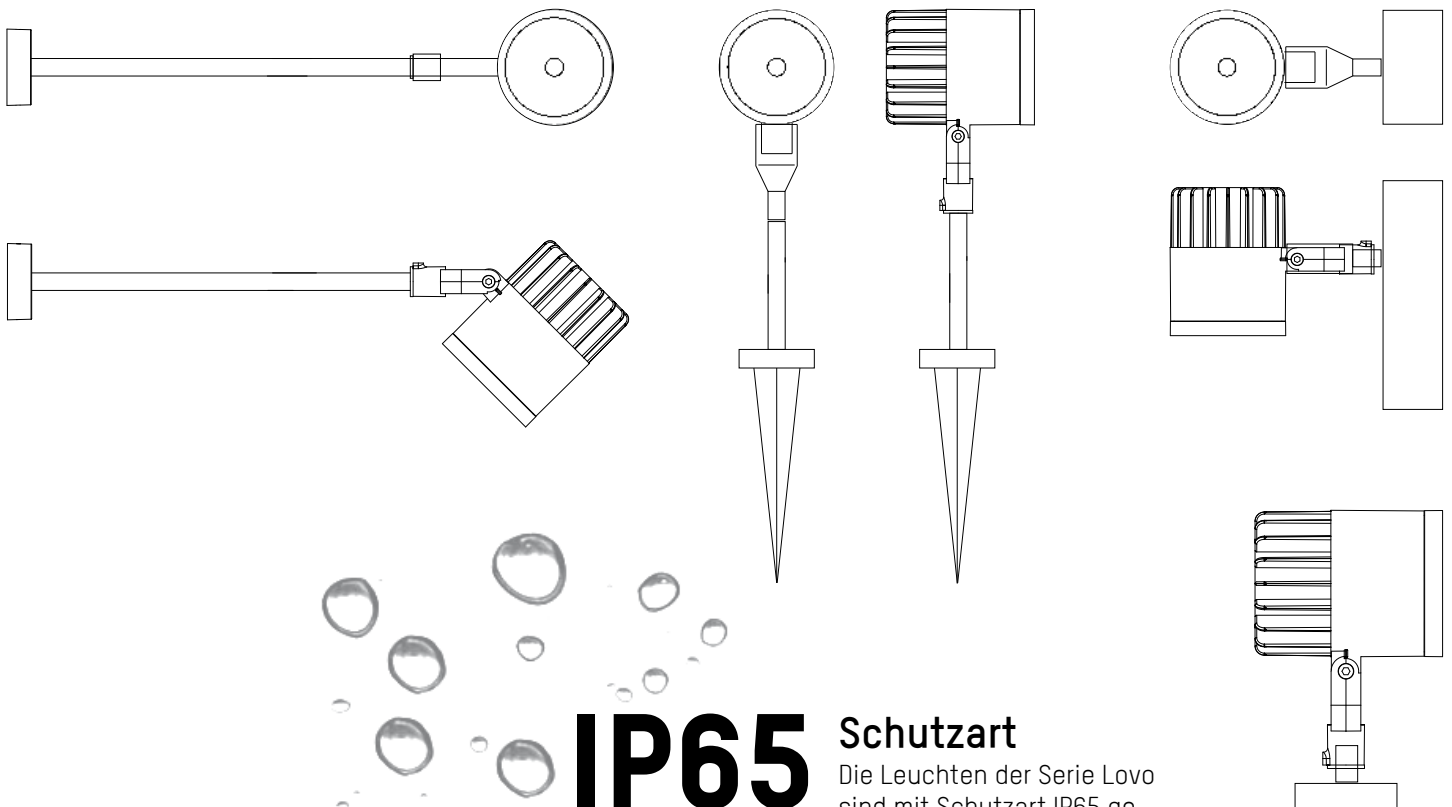

## IP65 Schutzart

Die Leuchten der Serie Lovo sind mit Schutzart IP65 gegen Staub genauso wie gegen Strahl-Wasser geschützt.

### Protection rating

The Lovo range of luminaires comes in IP65 and is protected against dust and jets of water.

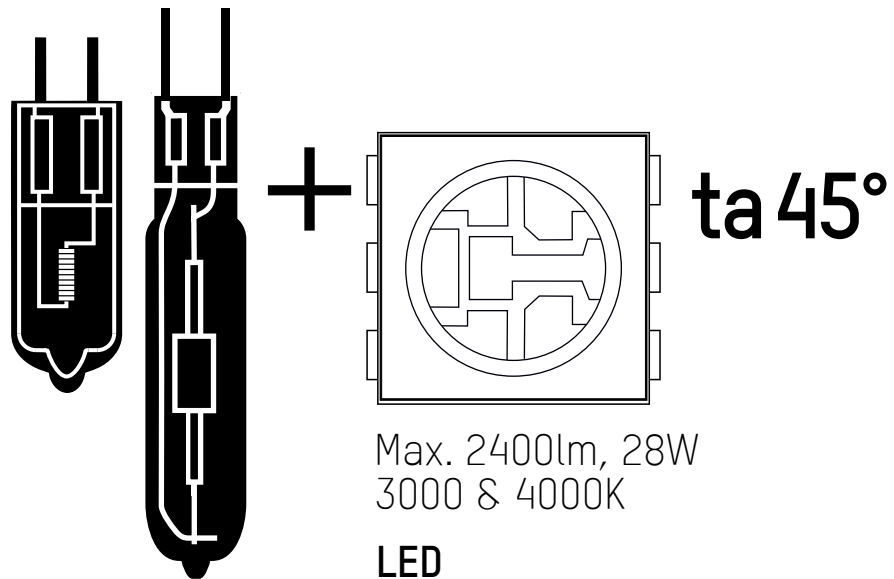

**LED**

Lovo ist, neben zahlreichen Varianten mit Metalldampf und NV-Halogen Lampen, auch mit effizienter LED-Bestückung erhältlich.

Dies in 2 Lichtfarben und mit maximal 2400lm bei 28W Systemleistung.

Besides various versions with sodium vapour and NV halogen lamps, Lovo is also available with efficient LED, in 2 light colours and a maximum of 2400lm for 28W of system power.

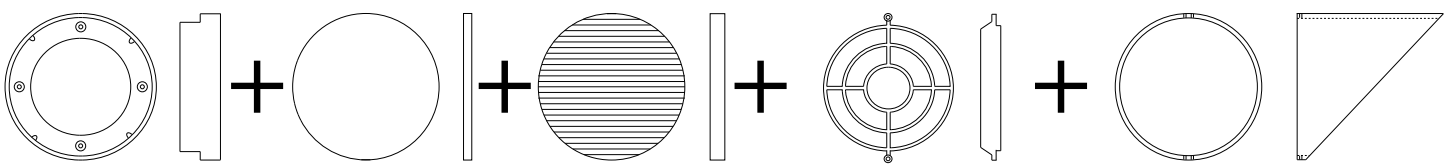
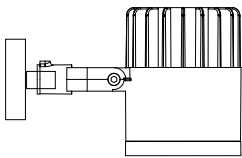
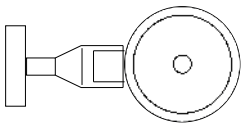

**Zubehör**

Für die Fluter-Serie Lovo bietet Hoffmeister eine vollständige Zubehör-Palette an. Selbstverständlich sind alle Zubehörkomponenten individuell an normierten Durchmessern verwendbar und einfach zu wechseln.

**Accessories**

Hoffmeister offers a complete range of accessories for the Lovo floodlight range. It goes without saying that all accessory components can be used individually on standard diameters and are easy to change.

LED perfect.white

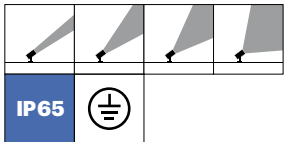

**Scheinwerfer LOVO**

- zur Montage an Wand oder Decke
- mit LED
- L90/B10 (50.000 h), SDCM < 3
- rotationssymmetrische Lichtverteilung
- spot, medium, flood
- eingebautes LED-Betriebsgerät, elektronisch, 220-240 V, 50/60 Hz
- zweiteilige Befestigungsplatte mit elektrischer Steckverbindung für einfachste Montage
- 2 Leitungseinführungen für Wandanschluss
- Gehäuse aus Aluminium-Druckguss
- Sicherheitsglas, klar oder Mikrostruktur
- Wandplatte aus Aluminium-Druckguss
- 300 ° drehbar, 90 ° schwenkbar
- IP65, Schutzklasse I
- maximale Umgebungstemperatur: 45 °C
- Farbe: anthrazit, silber

**projector LOVO**

- for surface mounted installation on wall or ceiling
- with LED
- L90/B10 (50.000 h), SDCM < 3
- rotationally symmetric light distribution
- spot, medium, flood
- with built-in LED power unit, electronic, 220-240 V, 50/60 Hz
- two-part mounting plate with electrical plug connection for the simplest mounting
- 2 cable entries for wall connection
- housing of die cast aluminium
- safety glass, clear or microstructure
- wall mounting plate of die cast aluminium
- rotatable 300 °, 90 ° tiltable
- IP65, protection class I
- maximum ambient temperature: 45 °C
- colour: anthracite, silver

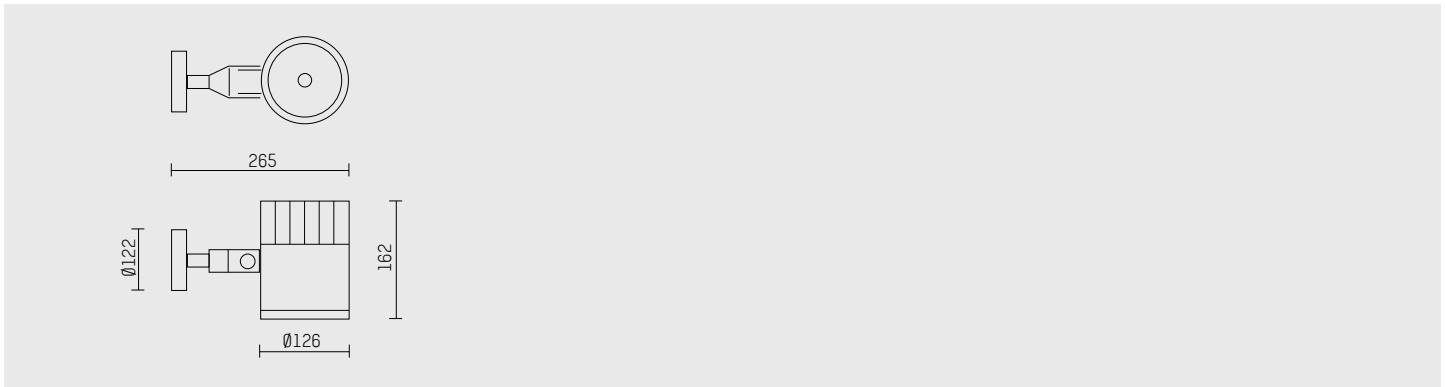

| Typ / type | Lichtstrom / lum. flux | Farbtemp. / colour temp. | Leistung / power       | CRI            | Lichtverteilung / light distribution | Winkel / angle | Betriebsgerät / control gear | Farbe / colour         | Art.-Nr. / item-No. |
|------------|------------------------|--------------------------|------------------------|----------------|--------------------------------------|----------------|------------------------------|------------------------|---------------------|
| LED        | 2100 lm                | 3000 K                   | 28 W                   | 90             | spot                                 | 10 °           | electronic                   | anthrazit / anthracite | 105 978 00 726      |
|            |                        |                          |                        |                |                                      |                |                              | silber / silver        | 105 978 00 916      |
|            |                        |                          |                        |                | 15 °                                 | electronic     | anthrazit / anthracite       | 105 980 00 726         |                     |
|            |                        |                          |                        |                |                                      |                |                              | silber / silver        | 105 980 00 916      |
|            |                        |                          |                        |                | medium                               | 23 °           | electronic                   | anthrazit / anthracite | 105 981 00 726      |
|            |                        |                          |                        |                |                                      |                |                              | silber / silver        | 105 981 00 916      |
| flood      | 44 °                   | electronic               | anthrazit / anthracite | 105 982 00 726 |                                      |                |                              |                        |                     |
|            |                        |                          | silber / silver        | 105 982 00 916 |                                      |                |                              |                        |                     |
| LED        | 1150 lm                | 3000 K                   | 14 W                   | 90             | spot                                 | 10 °           | electronic                   | anthrazit / anthracite | 105 976 00 726      |
|            |                        |                          |                        |                |                                      |                |                              | silber / silver        | 105 976 00 916      |
|            |                        |                          |                        |                | 15 °                                 | electronic     | anthrazit / anthracite       | 105 970 00 726         |                     |
|            |                        |                          |                        |                |                                      |                |                              | silber / silver        | 105 970 00 916      |
|            |                        |                          |                        |                | medium                               | 23 °           | electronic                   | anthrazit / anthracite | 105 971 00 726      |
|            |                        |                          |                        |                |                                      |                |                              | silber / silver        | 105 971 00 916      |
| flood      | 44 °                   | electronic               | anthrazit / anthracite | 105 972 00 726 |                                      |                |                              |                        |                     |
|            |                        |                          | silber / silver        | 105 972 00 916 |                                      |                |                              |                        |                     |

LED perfect.white

| Typ / type | Lichtstrom / lum. flux | Farbtemp. / colour temp. | Leistung / power | CRI | Lichtverteilung / light distribution | Winkel / angle | Betriebsgerät / control gear | Farbe / colour         | Art.-Nr. / item-No. |
|------------|------------------------|--------------------------|------------------|-----|--------------------------------------|----------------|------------------------------|------------------------|---------------------|
| LED        | 2400 lm                | 4000 K                   | 28 W             | 80  | spot                                 | 10 °           | electronic                   | anthrazit / anthracite | 105 979 00 726      |
|            |                        |                          |                  |     |                                      |                |                              | silber / silver        | 105 979 00 916      |
|            |                        |                          |                  |     |                                      | 15 °           | electronic                   | anthrazit / anthracite | 105 983 00 726      |
|            |                        |                          |                  |     |                                      |                |                              | silber / silver        | 105 983 00 916      |
|            |                        |                          |                  |     | medium                               | 23 °           | electronic                   | anthrazit / anthracite | 105 984 00 726      |
|            |                        |                          |                  |     |                                      |                |                              | silber / silver        | 105 984 00 916      |
|            |                        |                          |                  |     | flood                                | 44 °           | electronic                   | anthrazit / anthracite | 105 985 00 726      |
|            |                        |                          |                  |     |                                      |                |                              | silber / silver        | 105 985 00 916      |
| LED        | 1350 lm                | 4000 K                   | 14 W             | 80  | spot                                 | 10 °           | electronic                   | anthrazit / anthracite | 105 977 00 726      |
|            |                        |                          |                  |     |                                      |                |                              | silber / silver        | 105 977 00 916      |
|            |                        |                          |                  |     | spot                                 | 15 °           | electronic                   | anthrazit / anthracite | 105 973 00 726      |
|            |                        |                          |                  |     |                                      |                |                              | silber / silver        | 105 973 00 916      |
|            |                        |                          |                  |     | medium                               | 23 °           | electronic                   | anthrazit / anthracite | 105 974 00 726      |
|            |                        |                          |                  |     |                                      |                |                              | silber / silver        | 105 974 00 916      |
|            |                        |                          |                  |     | flood                                | 44 °           | electronic                   | anthrazit / anthracite | 105 975 00 726      |
|            |                        |                          |                  |     |                                      |                |                              | silber / silver        | 105 975 00 916      |

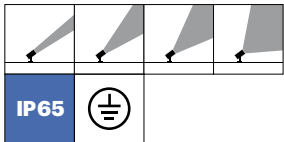
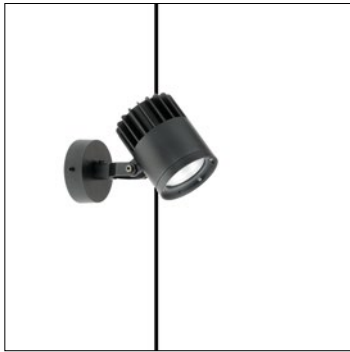

**Scheinwerfer LOVO**

- zur Montage an Wand oder Decke
- für Halogen-Metaldampflampe
- rotationssymmetrische Lichtverteilung
- narrow spot, spot, medium, flood
- Reflektor aus Aluminium, hochglänzend eloxiert
- eingebautes Vorschaltgerät, elektronisch
- Netzanschluss: Anschlussklemme 3x2,5 mm<sup>2</sup>
- zweiteilige Befestigungsplatte mit elektrischer Steckverbindung für einfachste Montage (nur ①)
- 2 Leitungseinführungen für Wandanschluss (nur ①)
- Gehäuse aus Aluminium-Druckguss
- Sicherheitsglas, klar
- Wandplatte aus Aluminium-Druckguss
- 300 ° drehbar, 90 ° schwenkbar
- IP65, Schutzklasse I
- Farbe: anthrazit, silber

**projector LOVO**

- for surface mounted installation on wall or ceiling
- for metal halide lamp
- rotationally symmetric light distribution
- narrow spot, spot, medium, flood
- reflector of aluminium, mirror finish anodised
- built-in ballast, electronic
- power supply: connecting terminal 3x2,5 mm<sup>2</sup>
- two-part mounting plate with electrical plug connection for the simplest mounting (only ①)
- 2 cable entries for wall connection (only ①)
- housing of die cast aluminium
- safety glass, clear
- wall mounting plate of die cast aluminium
- rotatable 300 °, 90 ° tiltable
- IP65, protection class I
- colour: anthracite, silver

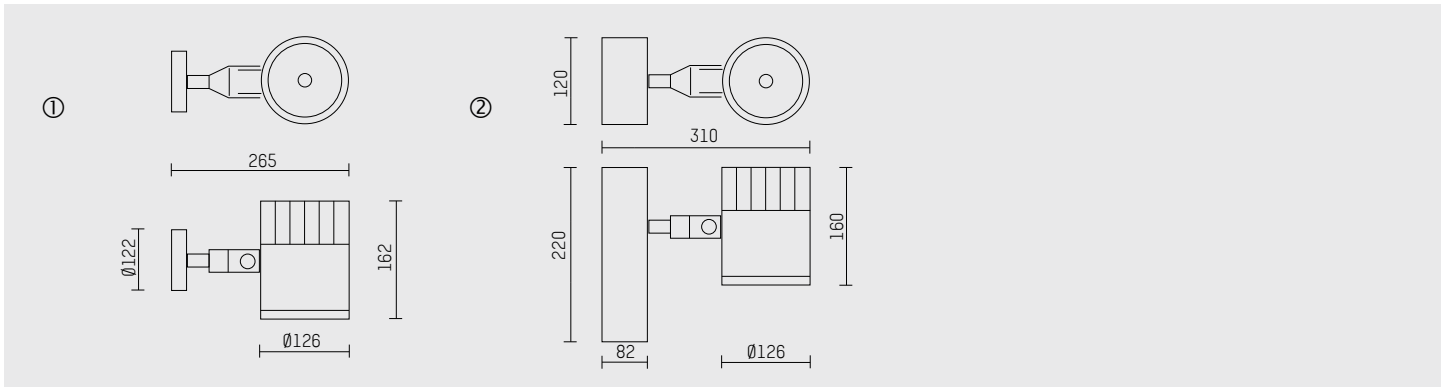

| Typ / type | Leistung / power | Socket / socket        | Lichtverteilung / light distribution | Betriebsgerät / control gear | Farbe / colour         | Skizze / drawing | Art.-Nr. / item-No. |
|------------|------------------|------------------------|--------------------------------------|------------------------------|------------------------|------------------|---------------------|
| HIT-TC-CE  | 20 W             | GU6.5                  | narrow spot                          | electronic                   | anthrazit / anthracite | 1                | 079 960 71 726      |
|            |                  |                        |                                      |                              | silber / silver        | 1                | 079 960 71 916      |
|            |                  |                        | spot                                 | electronic                   | anthrazit / anthracite | 1                | 079 961 71 726      |
|            |                  |                        |                                      |                              | silber / silver        | 1                | 079 961 71 916      |
|            |                  |                        | medium                               | electronic                   | anthrazit / anthracite | 1                | 079 962 71 726      |
|            |                  |                        |                                      |                              | silber / silver        | 1                | 079 962 71 916      |
| flood      | electronic       | anthrazit / anthracite | 1                                    | 079 963 71 726               |                        |                  |                     |
|            |                  | silber / silver        | 1                                    | 079 963 71 916               |                        |                  |                     |



| Typ / type | Leistung / power | Socket / socket | Lichtverteilung / light distribution | Betriebsgerät / control gear | Farbe / colour         | Skizze / drawing | Art.-Nr. / item-No. |
|------------|------------------|-----------------|--------------------------------------|------------------------------|------------------------|------------------|---------------------|
| HIT-TC-CE  | 35 W             | G8.5            | spot                                 | electronic                   | anthrazit / anthracite | 2                | 079 959 72 726      |
|            |                  |                 |                                      |                              | silber / silver        | 2                | 079 959 72 916      |

# LOVO | Scheinwerfer - projector | LED

mit Wandausleger - with extension bracket | LED perfect.white

**HOFFMEISTER**

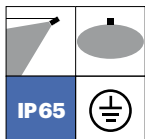

## Scheinwerfer LOVO mit Wandausleger

- zur Montage an Wand oder Decke
- mit LED
- L90/B10 (50.000 h), SDCM < 3
- bisymmetrische Lichtverteilung
- oval-flood
- eingebautes LED-Betriebsgerät, elektronisch, 220-240 V, 50/60 Hz
- zweiteilige Befestigungsplatte mit elektrischer Steckverbindung für einfachste Montage
- 2 Leitungseinführungen für Wandanschluss
- Gehäuse aus Aluminium-Druckguss
- Sicherheitsglas Mikroprismatik
- Wandausleger aus Aluminium
- Wandplatte aus Aluminium-Druckguss
- 300 ° drehbar, 90 ° schwenkbar
- IP65, Schutzklasse I
- maximale Umgebungstemperatur: 45 °C
- Farbe: anthrazit, silber

## projector LOVO with extension bracket

- for surface mounted installation on wall or ceiling
- with LED
- L90/B10 (50.000 h), SDCM < 3
- rotationally symmetric light distribution
- oval-flood
- with built-in LED power unit, electronic, 220-240 V, 50/60 Hz
- two-part mounting plate with electrical plug connection for the simplest mounting
- 2 cable entries for wall connection
- housing of die cast aluminium
- safety glass microprismatic
- extension bracket of aluminium
- wall mounting plate of die cast aluminium
- rotatable 300 °, 90 ° tiltable
- IP65, protection class I
- maximum ambient temperature: 45 °C
- colour: anthracite, silver

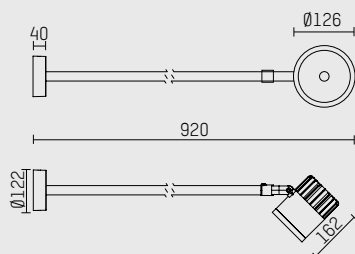

| Typ / type | Lichtstrom / lum. flux | Farbtemp. / colour temp. | Leistung / power | CRI | Lichtverteilung / light distribution | Betriebsgerät / control gear | Farbe / colour         | Art.-Nr. / item-No. |
|------------|------------------------|--------------------------|------------------|-----|--------------------------------------|------------------------------|------------------------|---------------------|
| LED        | 2100 lm                | 3000 K                   | 28 W             | 90  | oval-flood                           | electronic                   | anthrazit / anthracite | 107 962 00 726      |
|            |                        |                          |                  |     |                                      |                              | silber / silver        | 107 962 00 916      |
|            | 2400 lm                | 4000 K                   | 28 W             | >80 | oval-flood                           | electronic                   | anthrazit / anthracite | 107 963 00 726      |
|            |                        |                          |                  |     |                                      |                              | silber / silver        | 107 963 00 916      |
|            | 1150 lm                | 3000 K                   | 14 W             | 90  | oval-flood                           | electronic                   | anthrazit / anthracite | 107 960 00 726      |
|            |                        |                          |                  |     |                                      |                              | silber / silver        | 107 960 00 916      |
|            | 1350 lm                | 4000 K                   | 14 W             | >80 | oval-flood                           | electronic                   | anthrazit / anthracite | 107 961 00 726      |
|            |                        |                          |                  |     |                                      |                              | silber / silver        | 107 961 00 916      |



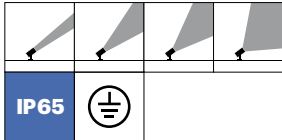

**Scheinwerfer LOVO mit Erdspieß**

- mit LED
- L90/B10 (50.000 h), SDCM < 3
- rotationssymmetrische Lichtverteilung
- spot, medium, flood
- eingebautes LED-Betriebsgerät, elektronisch, 220-240 V, 50/60 Hz
- Netzanschluss: Anschlussleitung, H07RN-F 3x1 mm<sup>2</sup>, Länge: 15 m
- Gehäuse aus Aluminium-Druckguss
- Sicherheitsglas, klar oder Mikrostruktur
- Erdspieß aus Aluminium-Druckguss
- 300 ° drehbar, 90 ° schwenkbar
- IP65, Schutzklasse I
- maximale Umgebungstemperatur: 45 °C
- Farbe: anthrazit, silber

**projector LOVO with spike**

- with LED
- L90/B10 (50.000 h), SDCM < 3
- rotationally symmetric light distribution
- spot, medium, flood
- with built-in LED power unit, electronic, 220-240 V, 50/60 Hz
- power supply: supply cord, H07RN-F 3x1 mm<sup>2</sup>, length: 15 m
- housing of die cast aluminium
- safety glass, clear or microstructure
- spike of die cast aluminium
- rotatable 300 °, 90 ° tilttable
- IP65, protection class I
- maximum ambient temperature: 45 °C
- colour: anthracite, silver

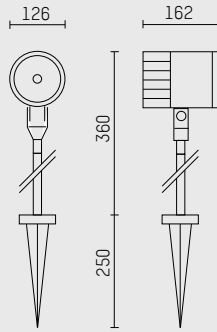

| Typ / type | Lichtstrom / lum. flux | Farbtemp. / colour temp. | Leistung / power       | CRI            | Lichtverteilung / light distribution | Winkel / angle | Betriebsgerät / control gear | Farbe / colour         | Art.-Nr. / item-No. |
|------------|------------------------|--------------------------|------------------------|----------------|--------------------------------------|----------------|------------------------------|------------------------|---------------------|
| LED        | 2100 lm                | 3000 K                   | 28 W                   | 90             | spot                                 | 10 °           | electronic                   | anthrazit / anthracite | 107 978 00 726      |
|            |                        |                          |                        |                |                                      |                |                              | silber / silver        | 107 978 00 916      |
|            |                        |                          |                        |                |                                      | 15 °           | electronic                   | anthrazit / anthracite | 107 980 00 726      |
|            |                        |                          |                        |                |                                      |                | silber / silver              | 107 980 00 916         |                     |
|            |                        |                          |                        |                | medium                               | 23 °           | electronic                   | anthrazit / anthracite | 107 981 00 726      |
|            |                        |                          |                        |                |                                      |                |                              | silber / silver        | 107 981 00 916      |
| flood      | 44 °                   | electronic               | anthrazit / anthracite | 107 982 00 726 |                                      |                |                              |                        |                     |
|            |                        |                          | silber / silver        | 107 982 00 916 |                                      |                |                              |                        |                     |
| LED        | 1150 lm                | 3000 K                   | 14 W                   | 90             | spot                                 | 10 °           | electronic                   | anthrazit / anthracite | 107 976 00 726      |
|            |                        |                          |                        |                |                                      |                |                              | silber / silver        | 107 976 00 916      |
|            |                        |                          |                        |                |                                      | 15 °           | electronic                   | anthrazit / anthracite | 107 970 00 726      |
|            |                        |                          |                        |                |                                      |                | silber / silver              | 107 970 00 916         |                     |
|            |                        |                          |                        |                | medium                               | 23 °           | electronic                   | anthrazit / anthracite | 107 971 00 726      |
|            |                        |                          |                        |                |                                      |                |                              | silber / silver        | 107 971 00 916      |
| flood      | 44 °                   | electronic               | anthrazit / anthracite | 107 972 00 726 |                                      |                |                              |                        |                     |
|            |                        |                          | silber / silver        | 107 972 00 916 |                                      |                |                              |                        |                     |

| Typ / type | Lichtstrom / lum. flux | Farbtemp. / colour temp. | Leistung / power       | CRI            | Lichtverteilung / light distribution | Winkel / angle | Betriebsgerät / control gear | Farbe / colour         | Art.-Nr. / item-No. |      |      |            |                        |                |
|------------|------------------------|--------------------------|------------------------|----------------|--------------------------------------|----------------|------------------------------|------------------------|---------------------|------|------|------------|------------------------|----------------|
| LED        | 2400 lm                | 4000 K                   | 28 W                   | >80            | spot                                 | 10 °           | electronic                   | anthrazit / anthracite | 107 979 00 726      |      |      |            |                        |                |
|            |                        |                          |                        |                |                                      |                |                              | silber / silver        | 107 979 00 916      |      |      |            |                        |                |
|            |                        |                          |                        |                | spot                                 | 15 °           | electronic                   | anthrazit / anthracite | 107 983 00 726      |      |      |            |                        |                |
|            |                        |                          |                        |                |                                      |                |                              | silber / silver        | 107 983 00 916      |      |      |            |                        |                |
|            |                        |                          |                        |                | medium                               | 23 °           | electronic                   | anthrazit / anthracite | 107 984 00 726      |      |      |            |                        |                |
|            |                        |                          |                        |                |                                      |                |                              | silber / silver        | 107 984 00 916      |      |      |            |                        |                |
|            |                        |                          |                        |                | flood                                | 44 °           | electronic                   | anthrazit / anthracite | 107 985 00 726      |      |      |            |                        |                |
|            |                        |                          |                        |                |                                      |                |                              | silber / silver        | 107 985 00 916      |      |      |            |                        |                |
|            |                        |                          |                        |                | LED                                  | 1350 lm        | 4000 K                       | 14 W                   | >80                 | spot | 10 ° | electronic | anthrazit / anthracite | 107 977 00 726 |
|            |                        |                          |                        |                |                                      |                |                              |                        |                     |      |      |            | silber / silver        | 107 977 00 916 |
| spot       | 15 °                   | electronic               | anthrazit / anthracite | 107 973 00 726 |                                      |                |                              |                        |                     |      |      |            |                        |                |
|            |                        |                          | silber / silver        | 107 973 00 916 |                                      |                |                              |                        |                     |      |      |            |                        |                |
| medium     | 23 °                   | electronic               | anthrazit / anthracite | 107 974 00 726 |                                      |                |                              |                        |                     |      |      |            |                        |                |
|            |                        |                          | silber / silver        | 107 974 00 916 |                                      |                |                              |                        |                     |      |      |            |                        |                |
| flood      | 44 °                   | electronic               | anthrazit / anthracite | 107 975 00 726 |                                      |                |                              |                        |                     |      |      |            |                        |                |
|            |                        |                          | silber / silver        | 107 975 00 916 |                                      |                |                              |                        |                     |      |      |            |                        |                |

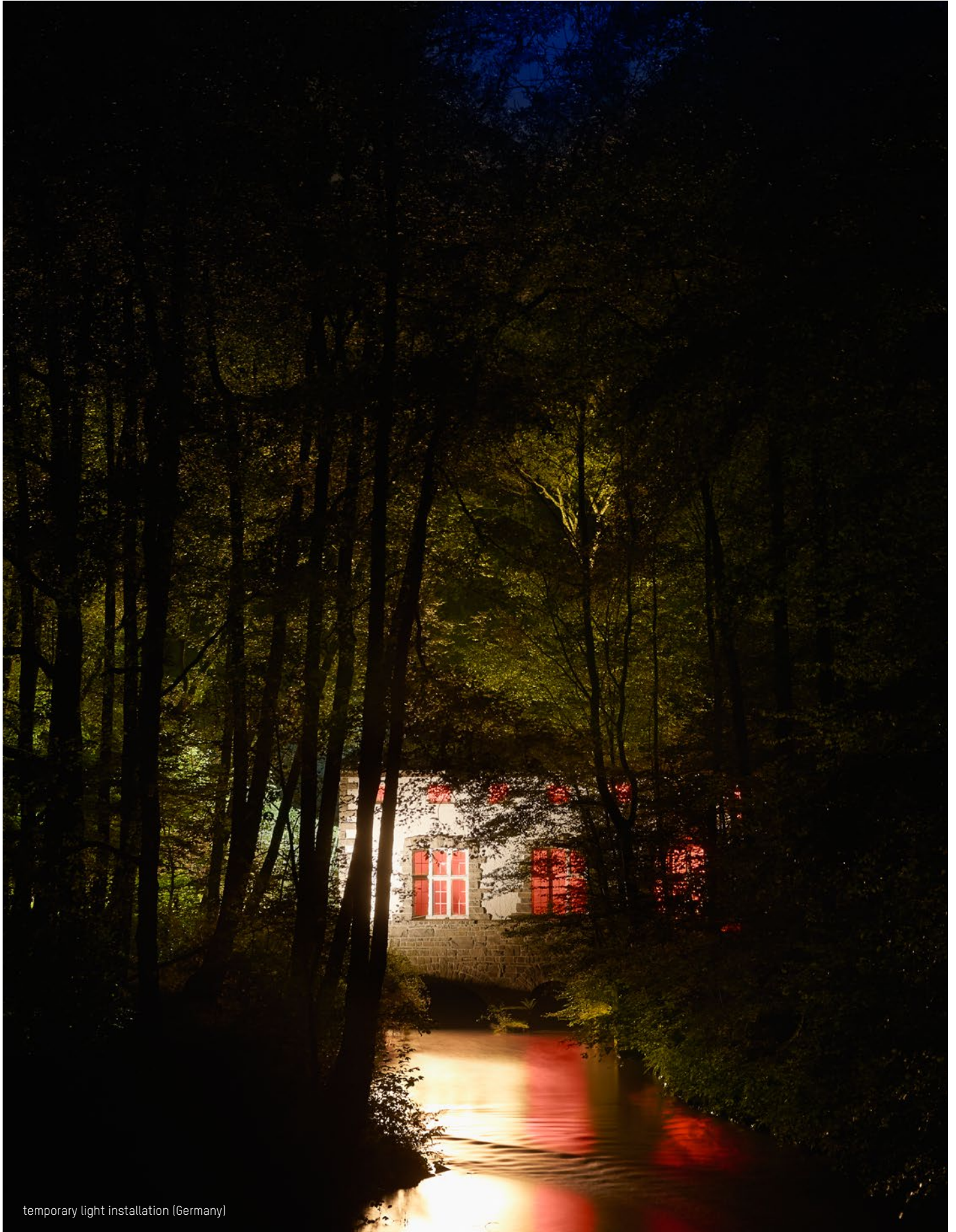

temporary light installation (Germany)

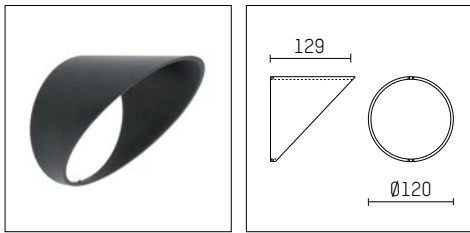

**Schute**

- für Scheinwerfer LOVO
- Material: Aluminium
- Farbe: silber, anthrazit

**visor**

- for projector LOVO
- material: aluminium
- colour: silver, anthracite

| Typ / type     | Farbe / colour         | Art.-Nr. / item-No. |
|----------------|------------------------|---------------------|
| Schute / visor | silber / silver        | 079 994 00 916      |
|                | anthrazit / anthracite | 079 994 00 726      |

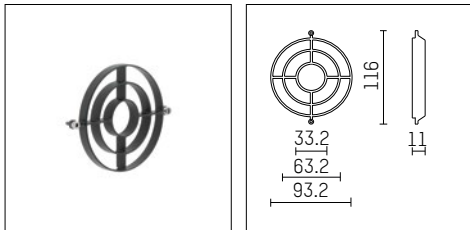

**Ringraster**

- für Scheinwerfer LOVO
- Material: Aluminium-Druckguss
- Farbe: schwarz

**ring louvre**

- for projector LOVO
- material: die cast aluminium
- colour: black

|                     |                |
|---------------------|----------------|
| Art.-Nr. / item-No. | 079 995 00 721 |
|---------------------|----------------|

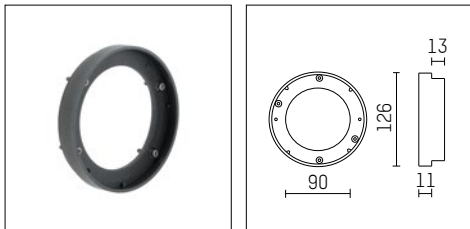

**Filterhalter**

- geeignet zur Aufnahme von Zubehör
- für Scheinwerfer LOVO
- Material: Aluminium-Druckguss
- Farbe: silber, anthrazit

**filter holder**

- suitable for attachment of accessories
- for projector LOVO
- material: die cast aluminium
- colour: silver, anthracite

| Typ / type  | Farbe / colour         | Art.-Nr. / item-No. |
|---|------------------------|---------------------|
| Filter- und Rasterhalter / filter and louvre holder | silber / silver        | 079 993 00 916      |
|   | anthrazit / anthracite | 079 993 00 726      |

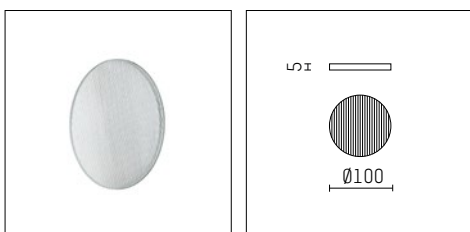

**Prismatikglas**

- für Scheinwerfer LOVO
- für optimale Ergebnisse nur mit engstrahlenden Reflektoren kombinieren
- nur in Verbindung mit Filter- und Rasterhalter

**prismatic glass**

- for projector LOVO
- combine with narrow-beam reflectors only for best results
- only together with filter and louvre holder

|                     |                |
|---------------------|----------------|
| Art.-Nr. / item-No. | 094 909 00 000 |
|---------------------|----------------|

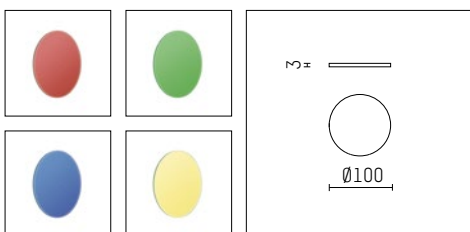

**Farbfilterglas**

- für Scheinwerfer LOVO
- nur in Verbindung mit Filter- und Rasterhalter

**colour filter**

- for projector LOVO
- only together with filter and louvre holder

| Typ / type                           | Farbe / colour | Art.-Nr. / item-No. |
|--------------------------------------|----------------|---------------------|
| Farbfilterglas / colour filter glass | rot / red      | 094 910 00 599      |
|                                      | grün / green   | 094 910 00 121      |
|                                      | blau / blue    | 094 910 00 399      |
|                                      | gelb / yellow  | 094 910 00 699      |