

Datasheet

GROUND LINER®

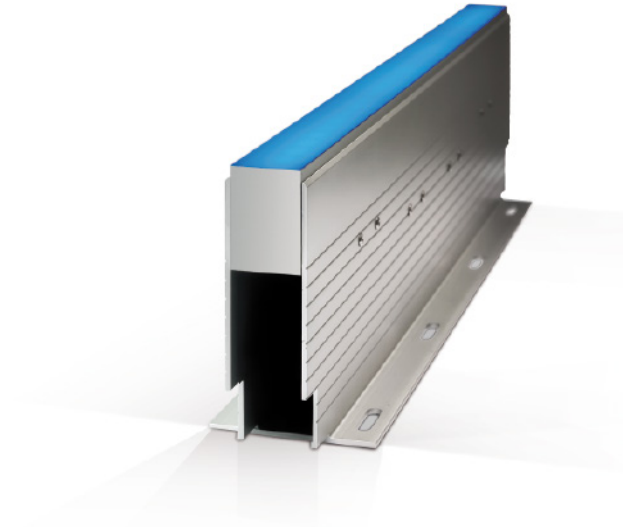

GROUND LINER®

DRIVE OVER 30 kN

- Continuous light for paths and squares
 - Recessed trimless luminaire
 - DMX control
 - Easy serial connection, up to 20 m
 - Up to 500 lm/m
 - Pressure on the fixture of 30 kN
 - 2 recessed boxes: 125 mm and 80 mm
- Luz continua para calles y plazas
 - Luminaria "trimless" empotrable
 - Control DMX
 - Fácil conexión en serie, hasta 20 m
 - Hasta 500 lm/m
 - Presión sobre la luminaria 30 kN
 - 2 cajas de empotrar: 125 mm and 80 mm

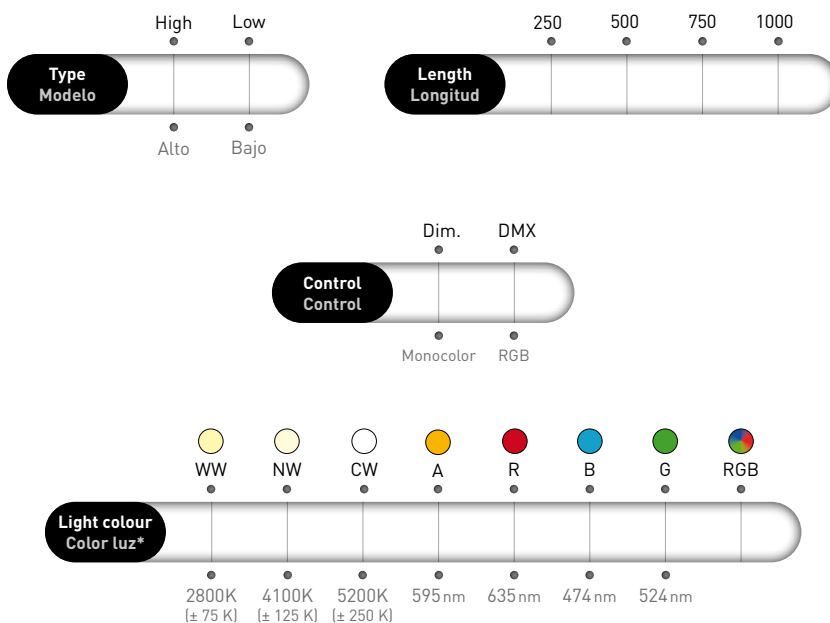

*The RGB version is delivered with DMX control.
La versión RGB se suministra con control DMX.*

** Due to tolerances of the production process the color temperatures could change slightly.
Debido a las tolerancias del proceso de producción las temperaturas del color pueden cambiar ligeramente.*

SPECIFICATIONS
CARACTERÍSTICAS

IP66 IP68	IK10	30 kN	 Dimmable	24V DC	 AL Housing	PUR resin Cover	HEAT SHOCK tested	Saltwater resistant	Ta min -20°C -4°F Ta max +50°C +122°F	
--------------	------	-------	--	-----------	--	--------------------	----------------------	------------------------	--	---

Ground Liner® 1000								
	[with high recessed box]				[with low recessed box]			
Measures	1000 x 130 x 75 mm				1000 x 85 x 76 mm			
Weight	4,5 kg				3,4 kg			
Color temperatures	2800K	4100K	5200K	Amber	Red	Blue	Green	RGB
Power	15,36 W	15,36 W	15,36 W	7,68 W	7,68 W	15,36 W	15,36 W	17,3 W
Nº LEDs	80 LEDs	80 LEDs	80 LEDs	80 LEDs	80 LEDs	80 LEDs	80 LEDs	60 LEDs
Lumens output	450 lm	485 lm	531 lm	255 lm	178 lm	136 lm	251 lm	240 lm
Luminaire efficiency	29 lm/W	32 lm/W	35 lm/W	29 lm/W	23 lm/W	9 lm/W	16 lm/W	14 lm/W
Control type	Dim.	Dim.	Dim.	Dim.	Dim.	Dim.	Dim.	DMX 512-A

Other types on next page >>>
Otros modelos en página siguiente >>>



Color temperature conform to **ANSI C78.377A**.
Lumens measurement conform to **LM-79-08**.
Lumens maintenance conform to **LM-80-08**.

Temperatura de color según normativa **ANSI C78.377A**.
Medición lumens según normativa **LM-79-08**.
Mantenimiento lumens según normativa **LM-80-08**.

Chicago Riverwalk,
USA

SPECIFICATIONS CARACTERÍSTICAS

Ground Liner® 750								
	(with high recessed box)				(with low recessed box)			
Measures	750 x 130 x 75 mm				750 x 85 x 75 mm			
Weight	3,37 kg				2,55 kg			
Color temperatures	2800K	4100K	5200K	Amber	Red	Blue	Green	RGB
Power	11,52 W	11,52 W	11,52 W	5,76 W	5,76 W	11,52 W	11,52 W	Not available No disponible
Nº LEDs	60 LEDs	60 LEDs	60 LEDs	60 LEDs	60 LEDs	60 LEDs	60 LEDs	
Lumens output	330 lm	360 lm	395 lm	191 lm	133 lm	102 lm	188 lm	
Luminaire efficiency	28 lm/W	31 lm/W	34 lm/W	33 lm/W	23 lm/W	9 lm/W	16 lm/W	
Control type	Dim.	Dim.	Dim.	Dim.	Dim.	Dim.	Dim.	

Ground Liner® 500								
	(with high recessed box)				(with low recessed box)			
Measures	500 x 130 x 75 mm				500 x 85 x 75 mm			
Weight	2,25 kg				1,65 kg			
Color temperatures	2800K	4100K	5200K	Amber	Red	Blue	Green	RGB
Power	7,68 W	7,68 W	7,68 W	3,84 W	3,84 W	7,68 W	7,68 W	8,7 W
Nº LEDs	40 LEDs	40 LEDs	40 LEDs	40 LEDs	40 LEDs	40 LEDs	40 LEDs	30 LEDs
Lumens output	221 lm	241 lm	265 lm	127 lm	89 lm	68 lm	124 lm	120 lm
Luminaire efficiency	29 lm/W	31lm/W	35 lm/W	33 lm/W	23 lm/W	9 lm/W	16 lm/W	14 lm/W
Control type	Dim.	Dim.	Dim.	Dim.	Dim.	Dim.	Dim.	DMX 512-A

Ground Liner® 250								
	(with high recessed box)				(with low recessed box)			
Measures	250 x 130 x 75 mm				250 x 85 x 75 mm			
Weight	1,19 kg				0,82 kg			
Color temperatures	2800K	4100K	5200K	Amber	Red	Blue	Green	RGB
Power	3,84 W	3,84 W	3,84 W	1,92 W	1,92 W	3,84 W	3,84 W	Not available No disponible
Nº LEDs	20 LEDs	20 LEDs	20 LEDs	20 LEDs	20 LEDs	20 LEDs	20 LEDs	
Lumens output	108 lm	119 lm	131 lm	63 lm	44 lm	33 lm	61 lm	
Luminaire efficiency	28 lm/W	31 lm/W	34 lm/W	33 lm/W	23 lm/W	9 lm/W	16 lm/W	
Control type	Dim.	Dim.	Dim.	Dim.	Dim.	Dim.	Dim.	

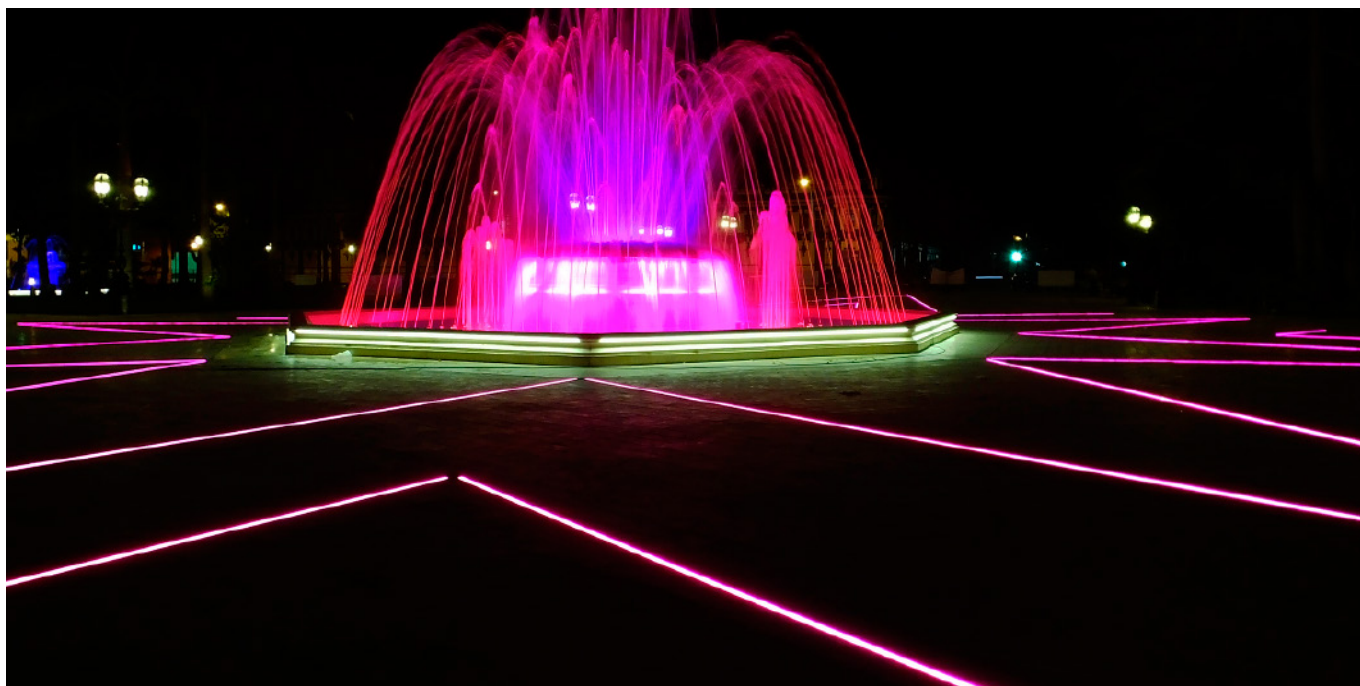

Bolívar Square,
Maracay, Venezuela

Color temperature conform to **ANSI C78.377A**.
Lumens measurement conform to **LM-79-08**.
Lumens maintenance conform to **LM-80-08**.

Temperatura de color según normativa **ANSI C78.377A**.
Medición lumens según normativa **LM-79-08**.
Mantenimiento lumens según normativa **LM-80-08**.

**LIGHT DISTRIBUTION CURVES
FOTOMETRÍAS**

Ground Liner® 1000

80 LEDs **120°**

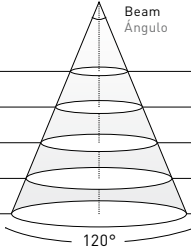
Distance Distancia	Beam Ángulo	Diameter Diámetro
1 m		3,28 m
2 m		6,56 m
3 m		9,84 m
4 m		13,12 m
5 m		16,40 m

2800K
WARM WHITE BLANCO CÁLIDO
122 lux
30 lux
14 lux
8 lux
5 lux

4100K
NEUTRAL WHITE BLANCO NEUTRO
131 lux
33 lux
15 lux
8 lux
5 lux

5200K
COOL WHITE BLANCO FRÍO
147 lux
37 lux
16 lux
9 lux
6 lux

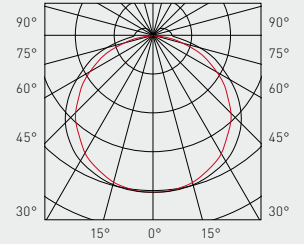

Ground Liner® 750

60 LEDs **120°**

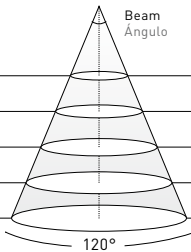
Distance Distancia	Beam Ángulo	Diameter Diámetro
1 m		3,28 m
2 m		6,56 m
3 m		9,84 m
4 m		13,12 m
5 m		16,40 m

2800K
WARM WHITE BLANCO CÁLIDO
89 lux
22 lux
10 lux
6 lux
4 lux

4100K
NEUTRAL WHITE BLANCO NEUTRO
97 lux
24 lux
11 lux
6 lux
4 lux

5200K
COOL WHITE BLANCO FRÍO
110 lux
27 lux
12 lux
7 lux
4 lux

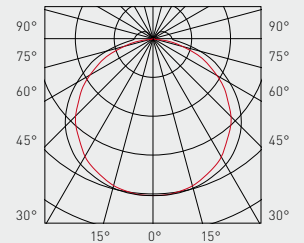

Ground Liner® 500

40 LEDs **120°**

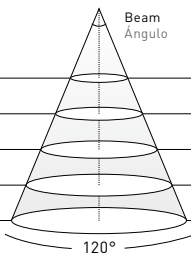
Distance Distancia	Beam Ángulo	Diameter Diámetro
1 m		3,28 m
2 m		6,56 m
3 m		9,84 m
4 m		13,12 m
5 m		16,40 m

2800K
WARM WHITE BLANCO CÁLIDO
60 lux
15 lux
7 lux
4 lux
2 lux

4100K
NEUTRAL WHITE BLANCO NEUTRO
65 lux
16 lux
7 lux
4 lux
3 lux

5200K
COOL WHITE BLANCO FRÍO
74 lux
18 lux
8 lux
5 lux
3 lux

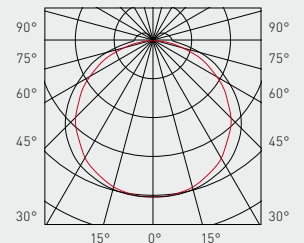

Ground Liner® 250

20 LEDs **120°**

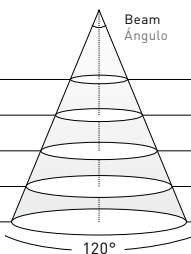
Distance Distancia	Beam Ángulo	Diameter Diámetro
1 m		3,28 m
2 m		6,56 m
3 m		9,84 m
4 m		13,12 m
5 m		16,40 m

2800K
WARM WHITE BLANCO CÁLIDO
29 lux
7 lux
3 lux
2 lux
1 lux

4100K
NEUTRAL WHITE BLANCO NEUTRO
32 lux
8 lux
4 lux
2 lux
1 lux

5200K
COOL WHITE BLANCO FRÍO
36 lux
9 lux
4 lux
2 lux
1 lux

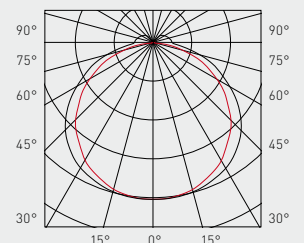

Lumen measurement complies with **UNE-EN 13032 / IES LM-79-08** testing procedures.
Light distribution curves are available at www.grupo-mci.com.
Due to continuous improvements and innovations, specifications may change without notice.

Ensayado bajo las especificaciones de la norma **UNE-EN 13032 / IES LM-79-08**.
Fotometrías disponibles en www.grupo-mci.com.
Debido a las continuas mejoras e innovaciones, las especificaciones pueden cambiar sin previo aviso.

MEASURES MEDIDAS

Ground Liner®
Luminaire.
Luminaria.

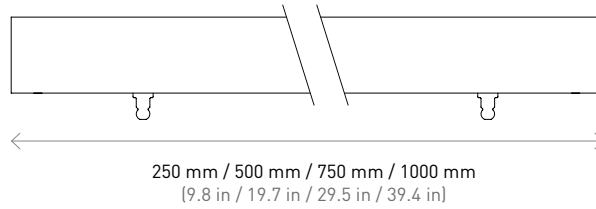
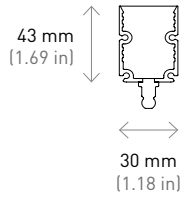

Ground Liner®
High recessed box+luminaire.
Cajetín de empotrar alto+luminaria.

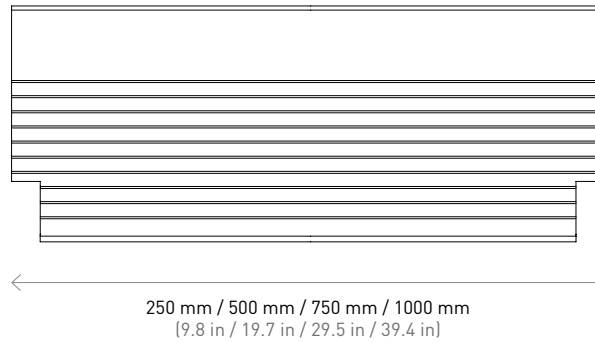
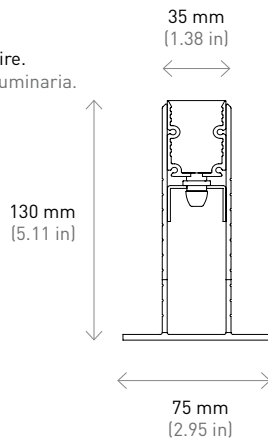

Ground Liner®
Low recessed box+luminaire.
Cajetín de empotrar bajo+luminaria.

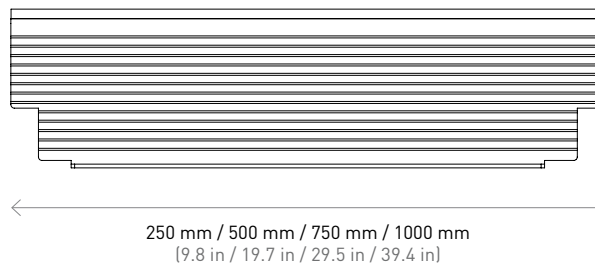
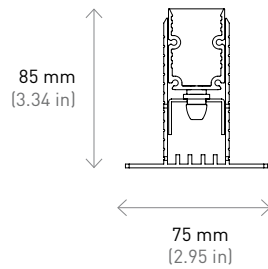

Polyethylene foam protects the recessed box of concrete dilatations.
Easy Plug&Play system for a fast installation in the recessed box.

La junta de polietileno absorbe las dilataciones del hormigón.
Unión rápida que permite montar con facilidad la luminaria en la caja de empotrar.

DETAILS
DETALLES



High recessed box (125 mm).
Cajetín de empotrar alto (125 mm).



Low recessed box (80 mm).
Cajetín de empotrar bajo (80 mm).



Monocolored IP66 connector for high recessed box.
Conector IP66 monocolor para cajetín de empotrar alto.



RGB and monocolored IP67 connector for low recessed box.
Conector IP67 RGB y monocolor para cajetín de empotrar bajo.



RGB IP68 connector for high recessed box.
Conector RGB IP68 para cajetín de empotrar alto.

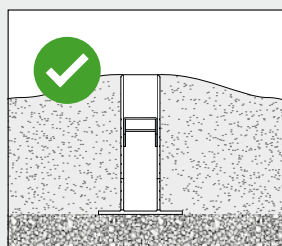
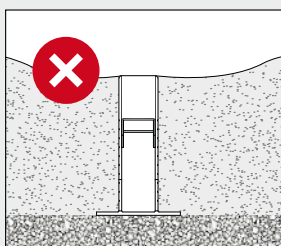

Temporarily
immersion
protection

A crushed stone surrounding the recessed box is recommended for a correct drainage. Avoid its placing in ground depression.
Incorrect drainage, may cause the loss of warranty.

Para un drenaje correcto se recomienda una capa de grava alrededor de la caja de empotramiento. Evite su colocación en depresiones del terreno.
Un drenaje incorrecto puede significar la pérdida de garantía.

MONOCOLOR CONNECTIONS WITH HIGH RECESSED BOX CONEXIONES MONOCOLOR CON CAJETIN DE EMPOTRAR ALTO

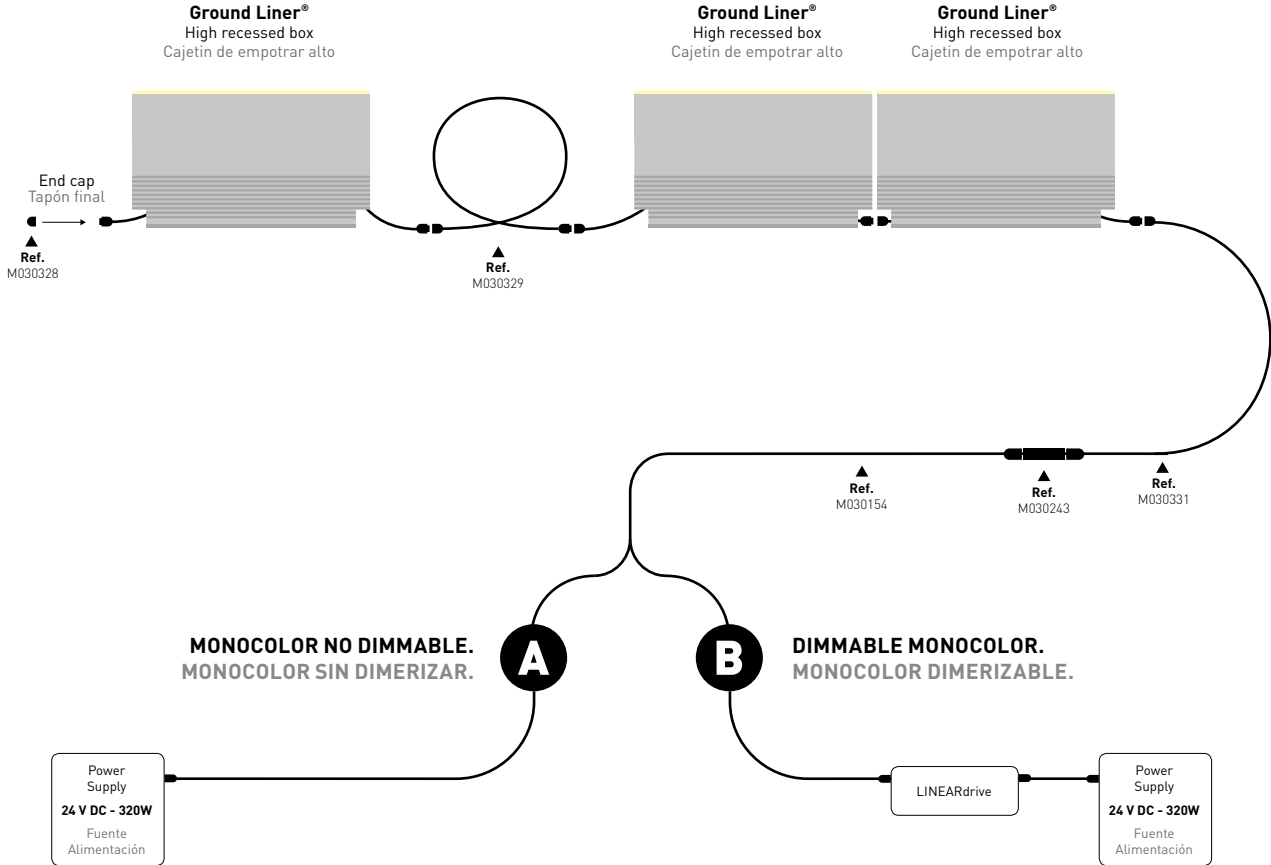

A

MONOCOLOR NO DIMMABLE MONOCOLOR SIN DIMERIZAR

15,36 W/m



Maximum 20 Ground Liner® of 1 m connected with PSU 24 V DC - 320W.
Maximum 5 m from power supply to first Ground Liner®.

Máximo 20 Ground Liner® de 1 m con fuente de alimentación
24 V DC - 320W.
Máximo 5 m de la fuente de alimentación al primer Ground Liner®.

7,68 W/m



Maximum 32 Ground Liner® of 1 m connected with PSU 24 V DC - 320W.
Maximum 5 m from power supply to first Ground Liner®.

Máximo 32 Ground Liner® de 1 m con fuente de alimentación
24 V DC - 320W.
Máximo 5 m de la fuente de alimentación al primer Ground Liner®.

B

DIMMABLE WITH LINEARdrive 720 DIMERIZABLE CON LINEARdrive 720

15,36 W/m

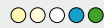

Maximum 20 Ground Liner® of 1 m connected with LINEARdrive 720
(PSU 24 V DC - 320W).
Maximum 5 m from power supply to first Ground Liner®.

Máximo 20 Ground Liner® de 1 m conectados al LINEARdrive 720
(fuente de alimentación 24 V DC - 320W).
Máximo 5 m de la fuente de alimentación al primer Ground Liner®.

7,68 W/m



Maximum 32 Ground Liner® of 1 m connected with LINEARdrive 720
(PSU 24 V DC - 320W).
Maximum 5 m from power supply to first Ground Liner®.

Máximo 32 Ground Liner® de 1 m conectados al LINEARdrive 720
(fuente de alimentación 24 V DC - 320W).
Máximo 5 m de la fuente de alimentación al primer Ground Liner®.

RGB CONNECTIONS WITH HIGH RECESSED BOX
CONEXIONES RGB CON CAJETIN DE EMPOTRAR ALTO

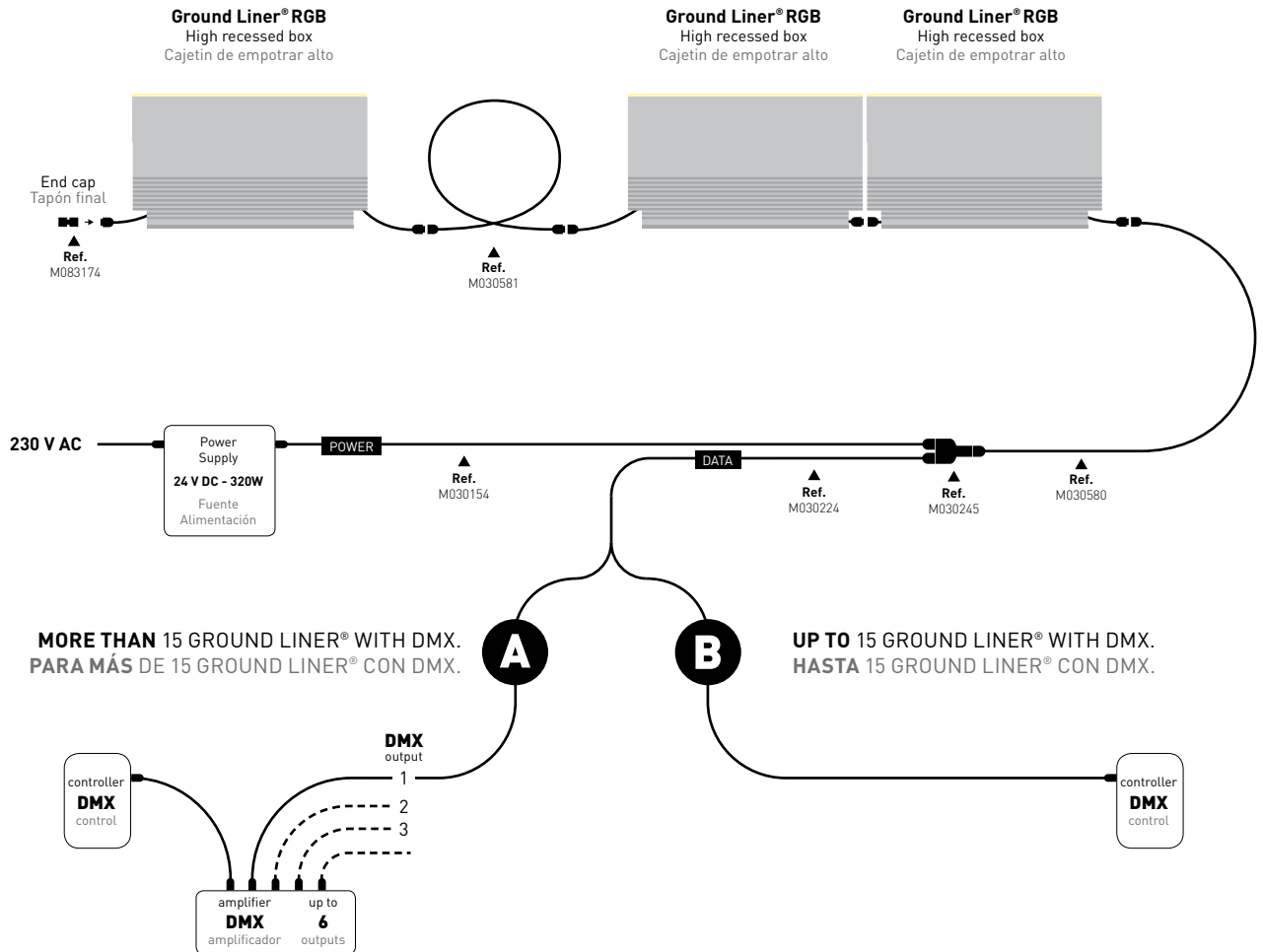

MORE THAN 15 GROUND LINER® WITH DMX.
PARA MÁS DE 15 GROUND LINER® CON DMX.

UP TO 15 GROUND LINER® WITH DMX.
HASTA 15 GROUND LINER® CON DMX.

A

MORE THAN 15 GROUND LINER® RGB WITH DMX 512-A.
PARA MÁS DE 15 GROUND LINER® RGB CON DMX 512-A.

Maximum 15 Ground Liner® RGB per DMX output.
 Maximum 100 meters from controller to the amplifier.
 Maximum 100 meters from amplifier to last Ground Liner® RGB.

Máximo 15 Ground Liner® RGB por salida DMX.
 Máximo 100 metros del controlador al amplificador.
 Máximo 100 metros del amplificador al último Ground Liner® RGB.

B

UP TO 15 GROUND LINER® RGB WITH DMX 512-A.
HASTA 15 GROUND LINER® RGB CON DMX 512-A.

Maximum 15 Ground Liner® RGB per DMX controller.
 Maximum 100 meters from controller to last Ground Liner® RGB.

Máximo 15 Ground Liner® RGB por controlador DMX.
 Máximo 100 metros del controlador al último Ground Liner® RGB.

MONOCOLOR CONNECTIONS WITH LOW RECESSED BOX CONEXIONES MONOCOLOR CON CAJETIN DE EMPOTRAR BAJO

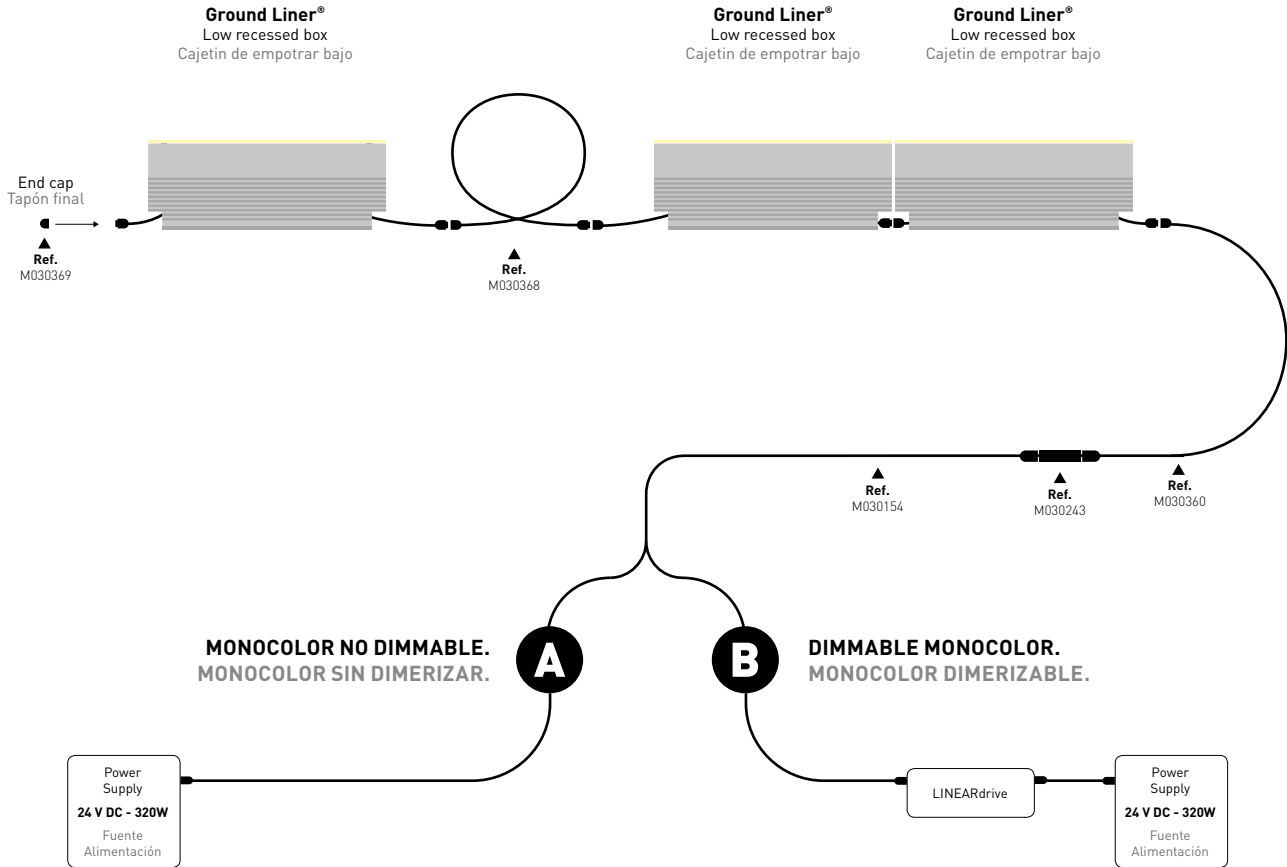

A

MONOCOLOR NO DIMMABLE MONOCOLOR SIN DIMERIZAR

15,36 W/m



Maximum 6 Ground Liner® of 1 m connected with PSU 24 V DC - 320W.
Maximum 5 m from power supply to first Ground Liner®.

Máximo 6 Ground Liner® de 1 m con fuente de alimentación
24 V DC - 320W.
Máximo 5 m de la fuente de alimentación al primer Ground Liner®.

7,68 W/m



Maximum 12 Ground Liner® of 1 m connected with PSU 24 V DC - 320W.
Maximum 5 m from power supply to first Ground Liner®.

Máximo 12 Ground Liner® de 1 m con fuente de alimentación
24 V DC - 320W.
Máximo 5 m de la fuente de alimentación al primer Ground Liner®.

B

DIMMABLE WITH LINEARdrive 720 DIMERIZABLE CON LINEARdrive 720

15,36 W/m



Maximum 6 Ground Liner® of 1 m connected with LINEARdrive 720
(PSU 24 V DC - 320W).
Maximum 5 m from power supply to first Ground Liner®.

Máximo 6 Ground Liner® de 1 m conectados al LINEARdrive 720
(fuente de alimentación 24 V DC - 320W).
Máximo 5 m de la fuente de alimentación al primer Ground Liner®.

7,68 W/m



Maximum 12 Ground Liner® of 1 m connected with LINEARdrive 720
(PSU 24 V DC - 320W).
Maximum 5 m from power supply to first Ground Liner®.

Máximo 12 Ground Liner® de 1 m conectados al LINEARdrive 720
(fuente de alimentación 24 V DC - 320W).
Máximo 5 m de la fuente de alimentación al primer Ground Liner®.

RGB CONNECTIONS WITH LOW RECESSED BOX
CONEXIONES RGB CON CAJETIN DE EMPOTRAR BAJO

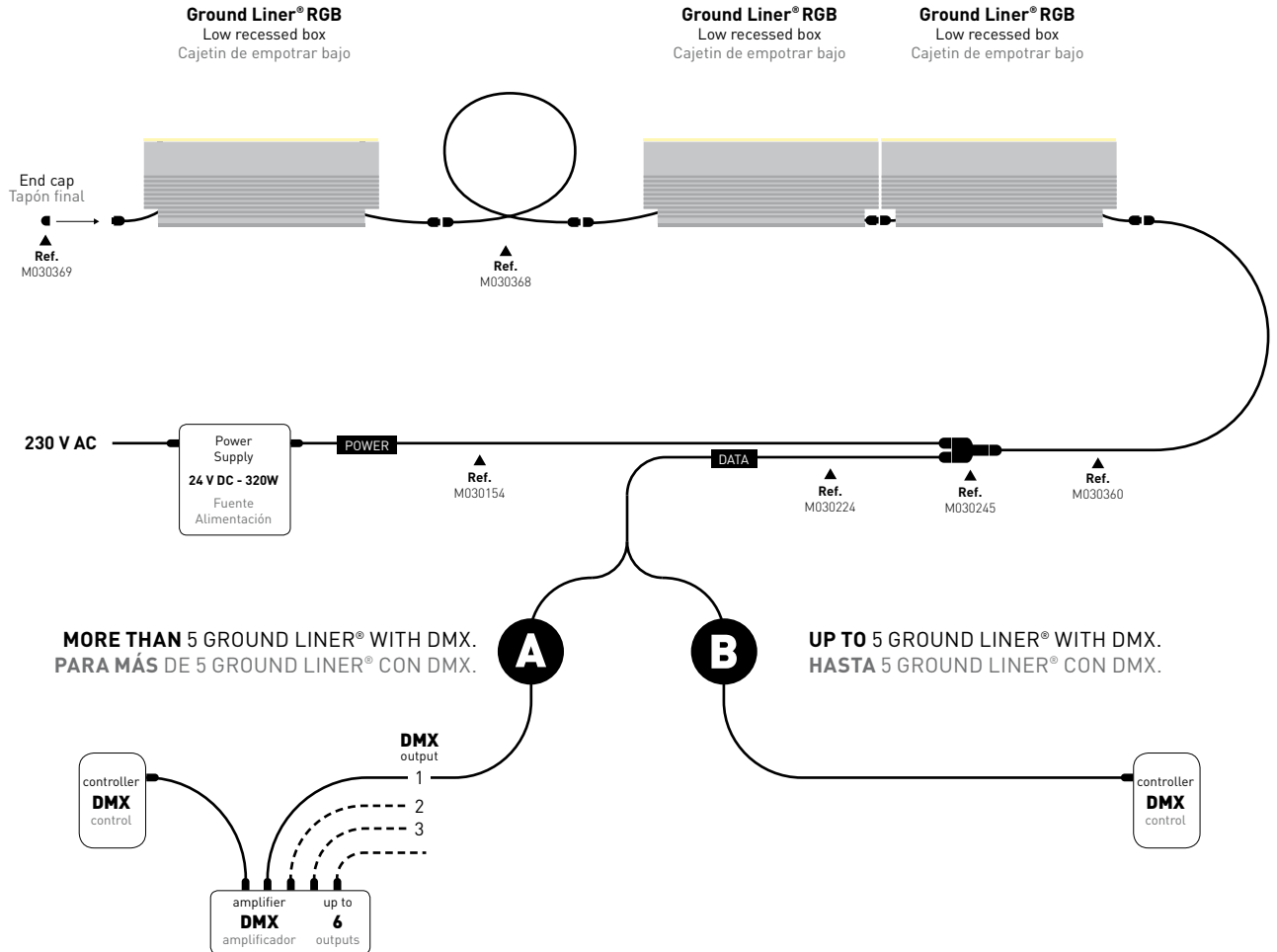

MORE THAN 5 GROUND LINER® WITH DMX.
PARA MÁS DE 5 GROUND LINER® CON DMX.

UP TO 5 GROUND LINER® WITH DMX.
HASTA 5 GROUND LINER® CON DMX.

A

MORE THAN 5 GROUND LINER® RGB WITH DMX.
PARA MÁS DE 5 GROUND LINER® RGB CON DMX.

Maximum 5 Ground Liner® RGB per DMX output.
 Maximum 100 meters from controller to the amplifier.
 Maximum 100 meters from amplifier to last Ground Liner® RGB.

Máximo 5 Ground Liner® RGB por salida DMX.
 Máximo 100 metros del controlador al amplificador.
 Máximo 100 metros del amplificador al último Ground Liner® RGB.

B

UP TO 5 GROUND LINER® RGB WITH DMX.
HASTA 5 GROUND LINER® RGB CON DMX.

Maximum 5 Ground Liner® RGB per DMX controller.
 Maximum 100 meters from controller to last Ground Liner® RGB.

Máximo 5 Ground Liner® RGB por controlador DMX.
 Máximo 100 metros del controlador al último Ground Liner® RGB.

DETAILS DETALLES

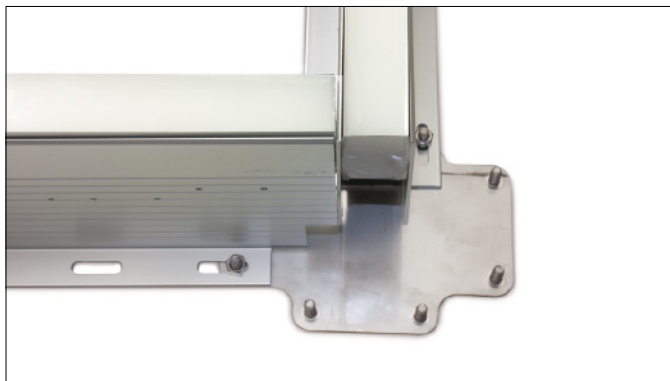

The fixation kit "ILX" allows the installation of several Ground Liner® creating a continuous light effect.

El kit de unión "ILX" permite la instalación de varios Ground Liner® creando efectos de luz continua.

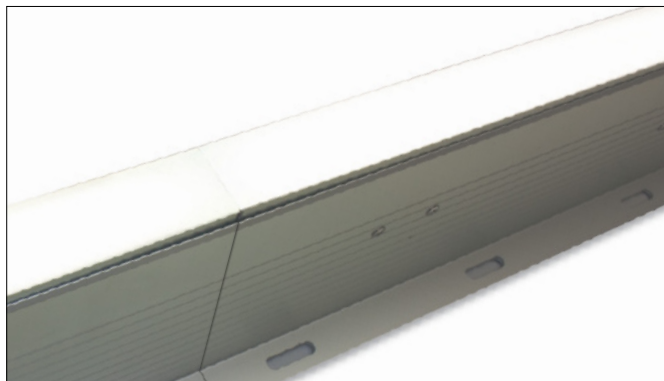

The fully resined fixture offers a protection class IP 66/68, an impact resistance IK10 and supports a pressure on the fixture of 30kN. To be walked on and drive on. Not allowed for motorways.

Luminaria completamente resinada, que ofrece un grado de protección IP66/68, un grado de impacto IK10 y soporta una presión sobre la luminaria de 30kN. Pisable y transitable. No apto para vías rápidas.



San Andrés Square,
Talavera de la Reina, SPAIN.

INSTALLATION
INSTALACIÓN

1 Recessed box installation.
Instalación cajetín.

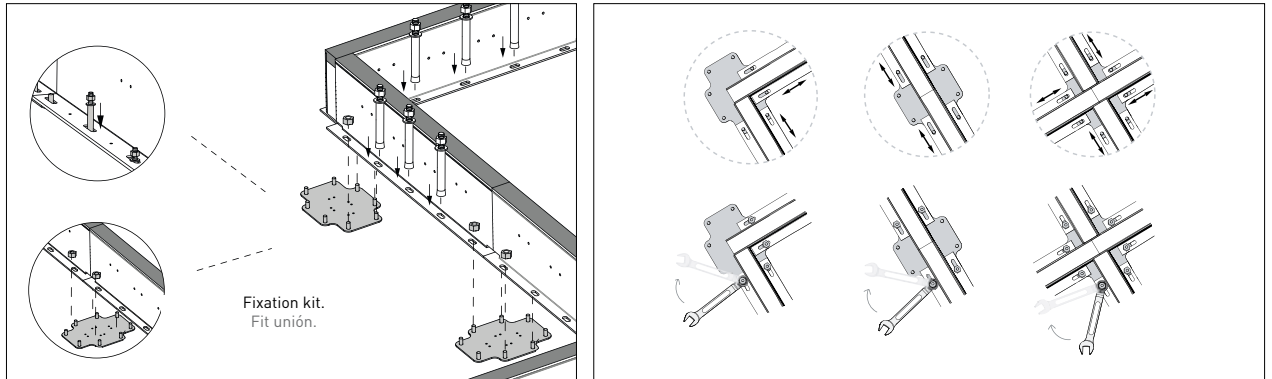

2 Concrete.
Hormigonado.

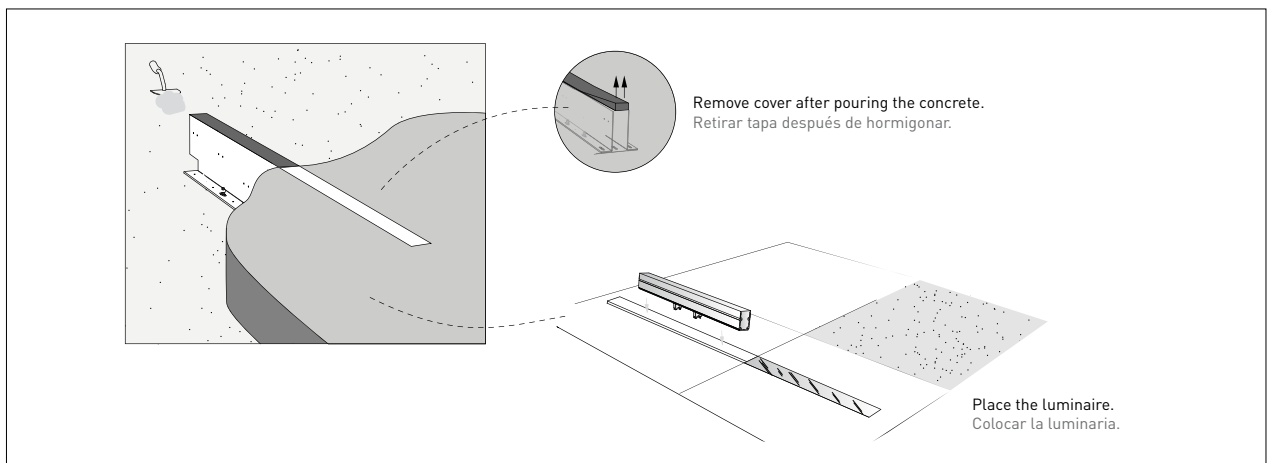

3 Extraction tool.
Útil de extracción.

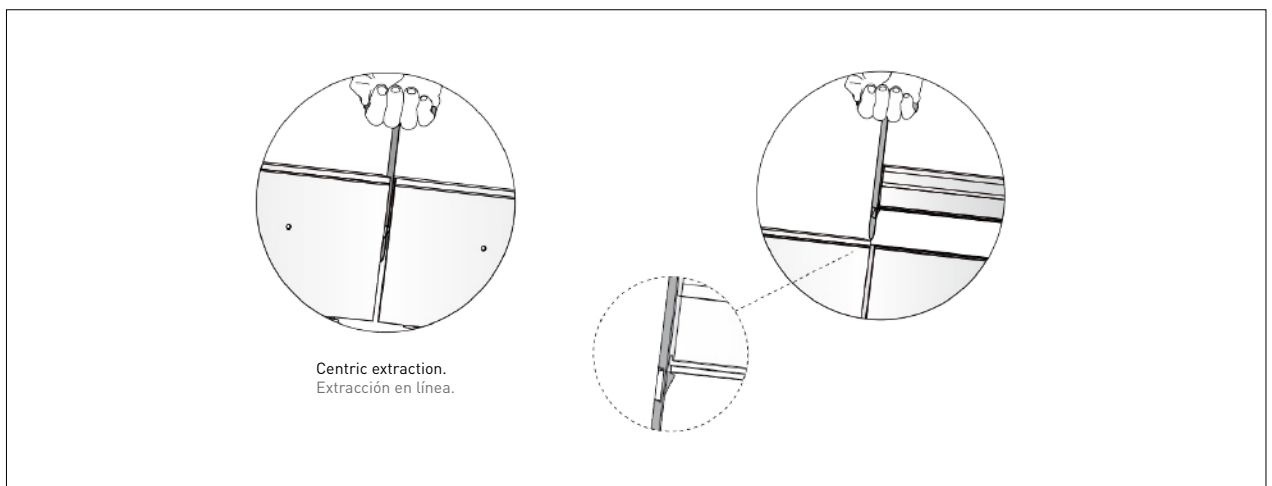

REFERENCES REFERENCIAS

71011 0 1 /80/2K8

COLOR COLOR

/80/2K8	2800K
/80/4K1	4100K
/80/5K2	5200K
/03	Red Rojo
/04	Amber Ambar
/08	Green Verde
/09	Blue Azul
/11	RGB *

LENGTH LONGITUD

1	1000 mm
2	750 mm
3	500 mm
4	250 mm**

RECESSED BOX HEIGHT ALTURA DEL CAJETIN

0	(125 mm) High Alto
1	(80 mm) Low Bajo

* Only available in 1000 mm and 500 mm.
Sólo disponible en 1000 mm y 500 mm.

** Only suitable for end of the line.
Sólo para final de línea.

ACCESSORIES REFERENCES REFERENCIAS ACCESORIOS



	For high recessed box (monocolor)	Para cajetín de empotrar alto (monocolor)	
M030331	1 m power cable	Cable alimentación 1 m	1
M030329	1 m extension cable	Cable extensión 1 m	2
M030328	End cap	Tapón final	
	For high recessed box (RGB)	Para cajetín de empotrar alto (RGB)	
M030580	2 m power cable (5 poles-female)	Cable alimentación 2 m (5 polos-hembra)	3
M030581	1 m extension cable (5 poles)	Cable extensión 1 m (5 polos)	4
M083174	120 OHM end cap (5 poles-male)	Tapón final 120 OHM (5 polos-macho)	
	For low recessed box (monocolor / RGB)	Para cajetín de empotrar bajo (monocolor / RGB)	
M030360	Power cable 70 cm	Cable alimentación 70 cm	5
M030368	Extension cable 1 m	Cable extensión 1 m	6
M030369	End cap	Tapón final	
	For installation.	Para instalación.	
M030243	IP68 "I" connection Ø6-13,5mm Tee Tube (3 poles)	Conexión "I" Ø6-13,5mm IP68 Tee Tube (3 polos)	7
M030245	IP68 "Y" connection Ø6-17mm Tee Tube (5 poles)	Conexión "Y" Ø6-17mm IP68 Tee Tube (5 polos)	8
M030154	3 x 1,5 mm ² H07RN-F cable (m)	Cable 3 x 1,5 mm ² H07RN-F (m)	
M030224	BELDEN 3105A cable (m)	Cable BELDEN 3105A (m)	
7150203	DMX Addresser Setup	DMX Addresser Setup	

RECESSED BOX
CAJETÍN DE EMPOTRAR



High recessed box (125 mm).
Cajetín de empotrar alto (125 mm).



Low recessed box (80 mm).
Cajetín de empotrar bajo (80 mm).

REFERENCES
REFERENCIAS

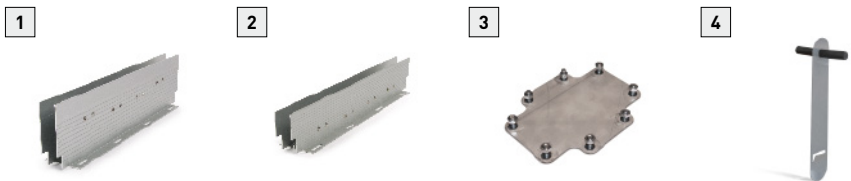

7101191/C12	High recessed box (125 mm). L.1000 mm	Cajetín de empotrar alto (125 mm). L.1000 mm	1
7101192/C12	High recessed box (125 mm). L.750 mm	Cajetín de empotrar alto (125 mm). L.750 mm	
7101193/C12	High recessed box (125 mm). L.500 mm	Cajetín de empotrar alto (125 mm). L.500 mm	
7101194/C12	High recessed box (125 mm). L.250 mm	Cajetín de empotrar alto (125 mm). L.250 mm	
7101171/C12	Low recessed box (80 mm). L.1000 mm	Cajetín de empotrar bajo (80 mm). L.1000 mm	2
7101172/C12	Low recessed box (80 mm). L.750 mm	Cajetín de empotrar bajo (80 mm). L.750 mm	
7101173/C12	Low recessed box (80 mm). L.500 mm	Cajetín de empotrar bajo (80 mm). L.500 mm	
7101174/C12	Low recessed box (80 mm). L.250 mm	Cajetín de empotrar bajo (80 mm). L.250 mm	
7101195	Fixation kit "ILX"	Kit unión "ILX"	3
7101196	Centric extraction tool	Útil extracción en línea	4

GROUND LINER®

Datasheet



Due to continuous improvements and innovations, specifications may change without notice.
Debido a continuas mejoras e innovaciones, las especificaciones pueden ser modificadas sin notificación.

16/07/18 © Grupo MCI

GRUPO MCI

C/ dels Oficis, n° 25
Pol. Ind. el Regàs
08850 · Gavà
Barcelona · SPAIN

T. (+34) 93 630 28 00
F. (+34) 93 630 29 66
M. info@grupo-mci.com

grupo-mci.com

FROM
BARCELONA
WITH LIGHT