

# AEC

NEWS 2024

## Biodiversity

L'approccio AEC verso  
tecnologie di eco-illuminazione  
*AEC approach toward  
eco-lighting technologies*

## NEWS 2024

Nuova gamma prodotti  
*New product range*

## AEC VISION

Investimenti  
*Investments*



ILLUMINAZIONE







# The company

AEC GROUP

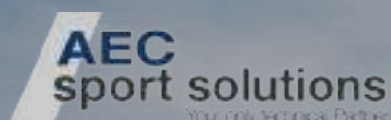

Dal 1957 siamo protagonisti di rilievo nel settore dell'illuminazione pubblica: Milano, Berlino, Londra, Abu Dhabi, Oslo, Auckland e Dubai sono solo alcune delle rinomate città illuminate da AEC. Oggi l'Azienda è un importante esempio di eccellenza industriale italiana, conosciuta ed apprezzata in tutto il mondo.

*Since 1957 We have been major players in the public lighting sector: Milan, Berlin, London, Oslo, Abu Dhabi, Auckland and Dubai are just some of the prestigious cities illuminated by AEC. Today the Company is an important example of Italian industrial excellence, known and appreciated all over the world.*





# SUMMARY

## 06

**Bilancio di  
sostenibilità**  
Sustainability Report

**Un progresso fatto  
di azioni**

*A progress made  
of actions*



## 08

**Tecnologie  
eco-sostenibili**  
eco-lighting  
technologies

**Un grande passo verso  
la biodiversità**

*A big step towards  
biodiversity*



## 20

**EPD**  
Environmental  
Product  
Declaration



## 22

**Nuova ottica Pentha**  
New Pentha Optic

**Nuova sorgente LED**  
Nuove performance

*New LED source  
New performance*



## 30

**Nuova ottica per  
attraversamenti  
pedonali**

*New optic for pedestrian  
crossings*

**Performance  
a confronto**

*Performance  
comparison*

## 36

**La visione di AEC  
sempre un passo  
avanti**

*AEC vision is always  
one step ahead*

**Il nuovo building**  
Assembly&Logistic

*The new building  
Assembly&Logistic*



## 38

**STOCK VERSION**

**Prodotti disponibili  
con consegna 48hr**

*Available products  
with 48hr delivery*



## 40

**La tecnologia  
solare di AEC**

*AEC Solar technology*

**A pieno ritmo verso  
soluzioni che utilizzano  
energia rinnovabile**

*At full speed towards solutions  
that using renewable energy*



## 44

**La nuova gamma  
di prodotti AEC**

*The new AEC  
product range*

**Prodotti orientati  
alla salvaguardia  
dell'ambiente**

*Products oriented  
towards protecting the  
environment*





# Bilancio di sostenibilità

## *Sustainability report*

Con grande entusiasmo presentiamo il nostro Bilancio di sostenibilità: un passo importante per valorizzare e divulgare l'insieme delle iniziative che, nel tempo, la nostra realtà ha intrapreso. È il tempo, il nostro, di diffondere capacità e nuove idee per il miglioramento dei processi, a beneficio delle persone e dell'ambiente nel quale viviamo.

*It is with great enthusiasm that we present our Sustainability Report: an important step to valorise and disclose the set of initiatives that, over time, our organization has undertaken. It is our time to deploy skills and new ideas for process improvement, for the well-being of people and the environment in which we live.*

### DOWNLOAD

**Registrati ed accedi all'area riservata del sito AEC per effettuare il download del bilancio di sostenibilità AEC**

*Register and access the reserved area of the AEC website to download the sustainability report.*



# Un progresso fatto di azioni

## *A progress made of actions*

I nostri progressi verso l'ambiente sono il risultato di innovazioni nella progettazione, nelle tecnologie e nell'organizzazione aziendale. Tramite il bilancio di sostenibilità vogliamo condividere quanto già abbiamo fatto e come affronteremo le sfide dei prossimi anni, con l'obiettivo di garantire una maggiore sostenibilità e ridurre il nostro impatto ambientale. Siamo fiduciosi che, attraverso un impegno continuo e una stretta collaborazione con i nostri dipendenti e stakeholder, possiamo contribuire a uno sviluppo sostenibile dando valore al nostro business, alle persone e al territorio.

*Our advancements towards the environment result from innovations in design, technologies, and organizational structure. Through the sustainability report, we aim to share what we have already accomplished and how we will meet the challenges of the coming years, with the goal of ensuring greater sustainability and reducing our environmental impact. We are confident that, through continuous commitment and close cooperation with our employees and stakeholders, we can contribute to sustainable development, adding value to our business, people, and the territory.*







ILLUMINAZIONE



**Un grande  
passo verso la  
biodiversità**

*A big step  
towards  
biodiversity*

Macro by DO



# Nuove tecnologie orientate alla tutela della biodiversità

L'illuminazione artificiale è da sempre collegata unicamente alle necessità degli esseri umani e non tiene conto dei suoi effetti negativi sull'ecosistema. La luce ha molta influenza su tutte le creature viventi: disturba anfibi, uccelli, mammiferi, insetti e altri animali e ne altera gli spostamenti, gli equilibri alimentari e la frequenza degli accoppiamenti. Da qui nasce la volontà di AEC di sviluppare soluzioni d'illuminazione orientate alla tutela ed esigenze della biodiversità.

Oltre al passaggio dalla luce del giorno alla notte, anche la luce della luna e delle stelle svolgono un ruolo determinante. Gli insetti svolgono numerose attività funzionali durante la notte dipendendo totalmente dall'oscurità in quanto li protegge dal caldo e permette loro di procurarsi il cibo necessario in totale sicurezza. Non solo: l'oscurità controlla il loro orientamento, i cicli biologici e riproduttivi.

La lucciola è un chiaro esempio di quanto un'illuminazione notturna troppo luminosa possa arrecare danno: di notte, infatti, nella totale oscurità, emettono il segnale luminoso ai maschi. Quando l'ambiente circostante è troppo luminoso, il maschio perde il loro segnale annullando così l'accoppiamento. Le fonti luminose artificiali causano disequilibrio negli ecosistemi, negli animali selvatici e nei ritmi circadiani umani. Si tratta di una vera e propria fonte di inquinamento, da sempre troppo sottovalutata. Per far fronte a questa importante tematica, AEC Illuminazione ha sviluppato delle tecnologie in grado di limitare l'inquinamento luminoso e preservare la biodiversità attraverso sistemi intelligenti e adattivi che illuminano solo dove e quando serve, controllando intensità e colore della luce.



# New technologies oriented towards the protection of biodiversity

Artificial lighting has always been linked solely to the needs of human beings and does not take into account its negative effects on the ecosystem. Light has a great influence on all living creatures: it disturbs amphibians, birds, mammals, insects and other animals and alters their movements, food balance and mating frequency. This is where AEC's desire to develop lighting solutions oriented towards the protection and needs of biodiversity was born.

In addition to the transition from daylight to night, the light of the moon and stars also play a decisive role. Insects carry out numerous functional activities during the night, totally dependent on the darkness as it protects them from the heat and allows them to obtain the necessary food in complete safety. Not only that: darkness controls their orientation, biological and reproductive cycles.

The firefly is a clear example of how too bright night lighting can cause damage: at night, in fact, in total darkness, they emit the light signal to the males. When the surrounding environment is too bright, the male loses their signal thus nullifying mating. Artificial light sources cause imbalance in ecosystems, wild animals and human circadian rhythms. It is a real source of pollution, which has always been too underestimated. To address this important issue, AEC Illuminazione has developed technologies capable of limiting light pollution and preserving biodiversity through intelligent and adaptive systems that illuminate only where and when needed, controlling the intensity and color of the light.



# La luce che incontra natura e biodiversità

Un altro esempio è quello del pipistrello: questi, cacciano solamente durante le ore notturne utilizzando l'ecolocalizzatore: emettono suoni nell'ambiente e ascoltano gli echi che rimbalzano da diversi oggetti. Gli echi sono usati per localizzare, identificare e stimare la distanza degli oggetti. L'ecolocalizzazione è usata dunque anche per l'orientamento e la ricerca del cibo in vari ambienti. Un'illuminazione troppo elevata, non permette il corretto orientamento e conseguentemente non consente di svolgere tutte le loro attività. Inoltre, una luce troppo luminosa che riflette lungo i corsi d'acqua, attira moltissimi insetti: anche questo è un fattore negativo in quanto pesci, uccelli e pipistrelli non trovano cibo. Oggi la tecnologia LED permette di progettare un'illuminazione sostenibile centrata all'uomo e all'intero ecosistema, orientata anche alle esigenze di insetti e animali notturni, controllando la distribuzione della luce, la direzione e l'intensità.



## *The light that meets nature and biodiversity*

*Another example is the bat: these hunt only during the night hours using the echolocator: they emit sounds in the environment and listen to the echoes that bounce from different objects. Echoes are used to locate, identify and estimate the distance of objects. Echolocation is therefore also used for orientation and searching for food or hunting in various environments. Excessively high lighting that reflects along waterways attracts many insects: this is also a negative factor as fish, birds and bats cannot find food. Today LED technology allows us to design sustainable human and animal lighting, also oriented to the needs of nocturnal insects and animals, controlling the distribution of light, direction and intensity.*



## Un nuovo approccio all'illuminazione: il bianco dinamico

Gli investimenti di AEC si stanno orientando sempre di più verso le esigenze e peculiarità del regno animale. I nuovi sistemi ottici, grazie a degli specifici controller, possono emettere differenti tonalità di luce in un range da 2200K ai 3000K. Si tratta di LED dinamici che permettono di gestire in qualsiasi momento tutta la scala del bianco. Il bianco dinamico offre diverse scenografie luminose in un unico corpo illuminante modificando l'intensità e il colore della luce e adattandosi in modo dinamico ai ritmi naturali della natura.

Importanti studi e ricerche hanno analizzato la distribuzione spettrale di potenza di differenti sorgenti luminose con le risposte comportamentali alle diverse lunghezze d'onda dei vari organismi viventi. Le sorgenti luminose con temperatura di colore più bassa hanno minore impatto su animali e vegetali. La maggior parte degli animali notturni sono infatti particolarmente sensibili alla componente blu della luce e quindi un'illuminazione fredda causa maggiori problemi di disorientamento, attrazione e alterazione dei rapporti predatori-prede.

Proprio per questo, più bassa è la temperatura del colore e minore sarà l'impatto sul regno animale. La tecnologia di AEC basata sul bianco dinamico nasce dall'esigenza di illuminare gli spazi con diversi livelli di luce e creare zone scure fondamentali per la natura, preservando la biodiversità.

## A new approach to lighting: Tunable White

*AEC's investments are increasingly oriented towards the needs and peculiarities of the animal kingdom. The new optical systems, thanks to specific controllers, can emit different shades of light in a range from 2200K to 3000K. These are dynamic LEDs that allow you to manage the entire white scale at any time. Tunable White offers different light scenes in a single luminaire, modifying the intensity and color of the light and dynamically adapting to the natural rhythms of nature.*

*Important studies and research have analyzed the spectral power distribution of different light sources with the behavioral responses to the different wavelengths of various living organisms. Light sources with lower color temperatures have less impact on animals and plants. Most nocturnal animals are in fact particularly sensitive to the blue component of light and therefore cold lighting causes greater problems of disorientation, attraction and alteration of predator-prey relationships.*

*Precisely for this reason, the lower the color temperature, the lower the impact on the animal kingdom. AEC technology based on Tunable White was born from the need to illuminate spaces with different light levels and create dark areas that are fundamental for nature, preserving biodiversity.*







## La tecnologia del bianco dinamico

AEC Illuminazione presenta la tecnologia Tunable White, una soluzione innovativa per un'illuminazione bilanciata in intensità e colore. Utilizzando una combinazione di LED con luce calda a 2200 K e luce fredda a 3000 K, la tecnologia consente di controllare separatamente due gruppi di LED, permettendo temperature di colore variabili da 2200 K a 3000 K con diversi livelli di intensità luminosa. Durante la serata, la tecnologia Tunable White fornisce una temperatura di colore media per accompagnare il ritorno di veicoli e pedoni. Nel cuore della notte, quando le strade sono tranquille, l'emissione di luce dei LED freddi viene ridotta, creando un'illuminazione più delicata e calda. Questo approccio a basso impatto energetico migliora la percezione e la sicurezza, rispettando l'ecosistema notturno. All'alba, quando le strade si animano nuovamente, l'emissione di luce dei LED freddi aumenta per garantire un'illuminazione più intensa e brillante, assicurando massima sicurezza.

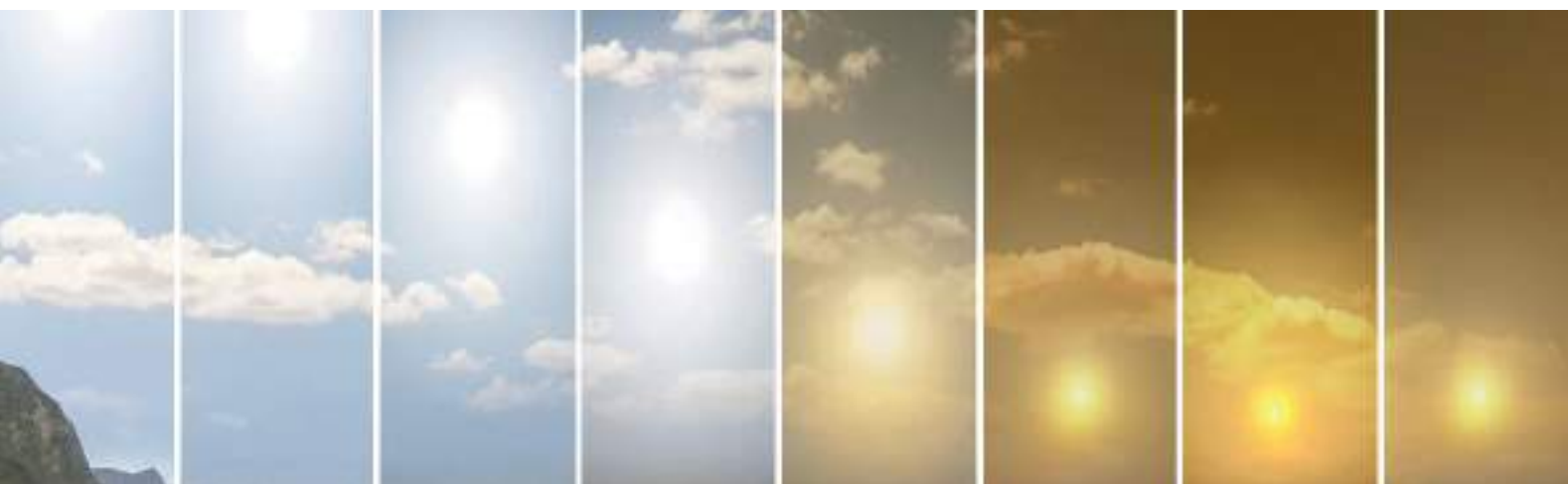

## Tunable White Technology

AEC Illuminazione presents Tunable White Technology, an innovative solution for balanced lighting in intensity and colour. Using a combination of 2200K warm light and 3000K cold light LEDs, the technology allows two groups of LEDs to be controlled separately, allowing for variable color temperatures from 2200K to 3000K with different levels of light intensity. During the evening, Tunable White Technology provides a medium color temperature to accompany the return of vehicles and pedestrians. In the middle of the night, when the streets are quiet, the light output of the cold LEDs is reduced, creating softer, warmer lighting. This low energy impact approach improves perception and safety, respecting the nocturnal ecosystem. At dawn, when the streets come alive again, the light output of the cold LEDs increases to ensure more intense and bright lighting, ensuring maximum safety.



## Nuove tecnologie che filtrano la componente blu

Sebbene un'illuminazione a temperatura più fredda (4000K) sia maggiormente efficace in quanto migliora la percezione visiva nelle strade, è anche maggiormente dannosa per flora e fauna a causa della sua ampia componente di blu. La luce blu, oltre a causare problemi di disorientamento degli animali, ha un effetto negativo anche sulle piante in quanto prolunga la fase di fotosintesi modificandone i processi di crescita. Le piante infatti utilizzano la luce sia come fonte di energia nei processi di fotosintesi sia per rilevare informazioni sul loro ambiente. Al fine di tutelare il nostro ecosistema, preservare la natura e tutti i suoi esseri viventi, i prodotti AEC sono disponibili con un apposito schermo che permette di filtrare il colore blu.



ILLUMINAZIONE

## *New technologies that filter the blue component*

*Although colder temperature lighting (4000K) is more effective as it improves visual perception in the streets, it is also more harmful to flora and fauna due to its large blue component. Blue light, in addition to causing disorientation problems for animals, also has a negative effect on plants as it prolongs the photosynthesis phase, modifying their growth processes. In fact, plants use light both as an energy source in photosynthesis processes and to detect information about their environment. In order to protect our ecosystem, preserve nature and all its living beings, AEC products are available with a special screen that allows the blue color to be filtered.*

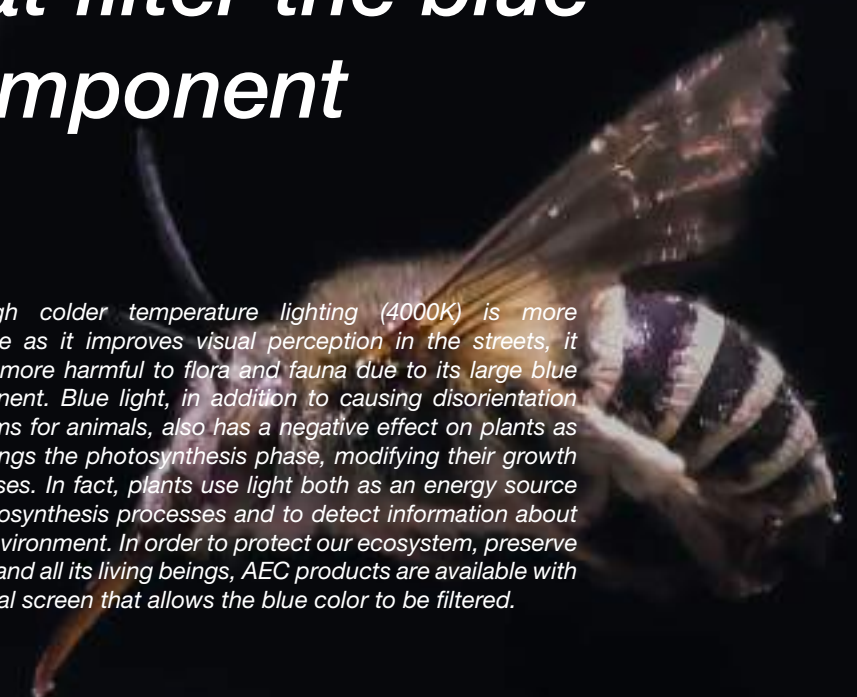



# EPD

## Environmental Product Declaration

Environmental product declaration (EPD) è una delle certificazioni maggiormente efficaci in termini di analisi di impatto ambientale in quanto contiene informazioni oggettive e quantificabili sugli impatti associati al ciclo di vita del prodotto. Tale certificazione è uno strumento immediato per sapere se un'azienda si sta realmente impegnando in ambito di sostenibilità, in quanto non si tratta di autodichiarazioni, bensì di documenti certificati da enti terzi accreditati. La valutazione dell'impatto ambientale e delle risorse consumate (materiali, acqua o energia) è possibile grazie all'analisi del Ciclo di Vita o LCA (Life Cycle Assessment) che definisce gli impatti sull'ambiente registrati nel corso delle varie fasi di produzione. Le fasi minime considerate vanno dall'estrazione delle materie prime, al loro trasporto, alla produzione, fino allo smaltimento del prodotto.

*The Environmental Product Declaration (EPD) is one of the most effective certifications in terms of environmental impact analysis as it contains objective and quantifiable information on the impacts associated with the life cycle of the product. This certification is an immediate tool to know if a company is truly committed to sustainability, as these are not self-declarations, but rather documents certified by accredited third-party bodies. The assessment of the environmental impact and the resources consumed (materials, water or energy) is possible due to the Life Cycle Analysis or LCA (Life Cycle Assessment) which defines the impacts on the environment recorded during the various stages of production. The minimum phases considered range from the extraction of raw materials, to their transport, to production, up to the disposal of the product.*

# LCA TOOL

## Life Cycle Assessment

Lo scopo di AEC è stato quello di sviluppare uno specifico tool, ovvero LCA Tool, un algoritmo di calcolo degli indicatori di impatto ambientale, costruito sulla base di una raccolta rappresentativa dei prodotti AEC e in grado di coprire le varie tipologie di materie prime utilizzate e lavorazioni effettuate.

*AEC purpose was to develop a specific tool, namely LCA Tool, an algorithm for calculating environmental impact indicators, built on the basis of a representative collection of AEC products and capable of covering the various types of raw materials used and work carried out.*





PENTHA

Nuova sorgente LED

Nuove performance

*New LED source*

*New performance*

Ottica in alluminio con  
finitura superficiale  
purissima 99,95% Classe  
A+ che garantisce efficienza  
energetica senza precedenti.

*Aluminium optic with a  
very pure 99.95% Class A+  
surface finish that guarantees  
unprecedented energy  
efficiency.*



PENTHA  
ALUMINIUM REFLECTOR TECHNOLOGY





La nuova  
isola robotizzata  
per la realizzazione  
ottica PENTHA

*The new  
robotic island  
for the development of  
PENTHA  
optics*



INDUSTRY 4.0



### STE-S

**Emissione stretta**  
 Ottica asimmetrica per illuminazione stradale extraurbana.

*Narrow emission*  
 Asymmetrical optic for suburban street lighting.

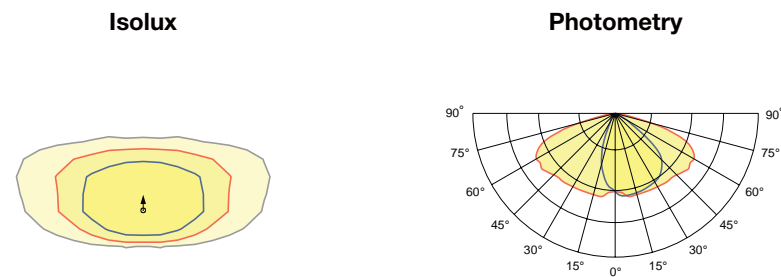

### STE-M

**Emissione media**  
 Ottica asimmetrica per illuminazione stradale extraurbana.

*Medium emission*  
 Asymmetrical optic for suburban street lighting.

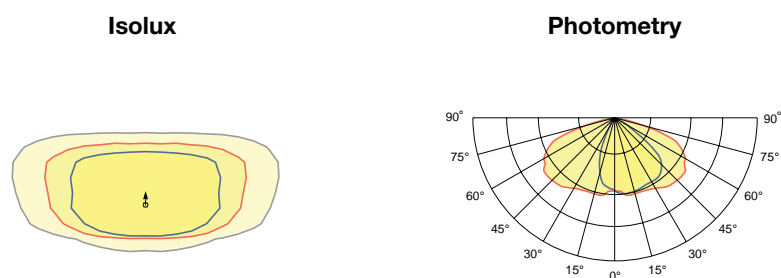

### STU-S

**Emissione stretta**  
 Ottica asimmetrica per illuminazione stradale, urbana e ciclopedonale.

*Narrow emission*  
 Asymmetrical optic for street, urban and cycle-path lighting.

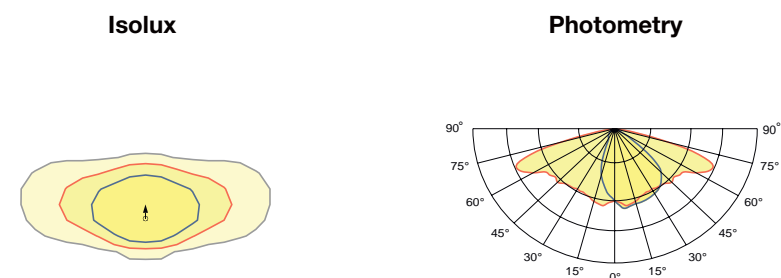

### STU-M

**Emissione media**  
 Ottica asimmetrica per illuminazione stradale, urbana e ciclopedonale.

*Medium emission*  
 Asymmetrical optic for street, urban and cycle-path lighting.

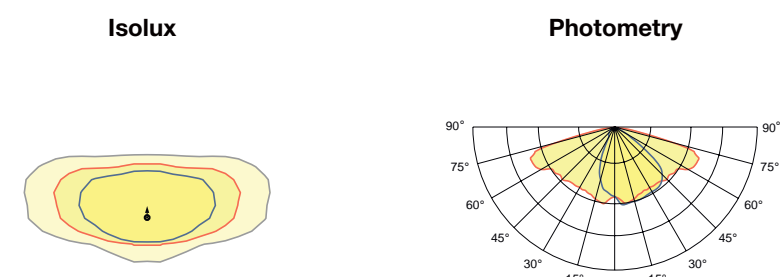

### STW

Ottica asimmetrica per illuminazione di strade larghe urbane ed extraurbane, specifica per asfalti bagnati.

*Asymmetrical optic for wide urban and suburban road lighting, specific for wet asphalts.*

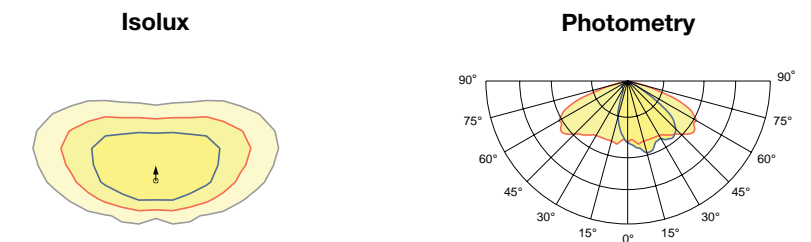

### S05

Ottica asimmetrica per illuminazione stradale, urbana e aree verdi.

*Asymmetrical optic for street, urban and green areas lighting.*

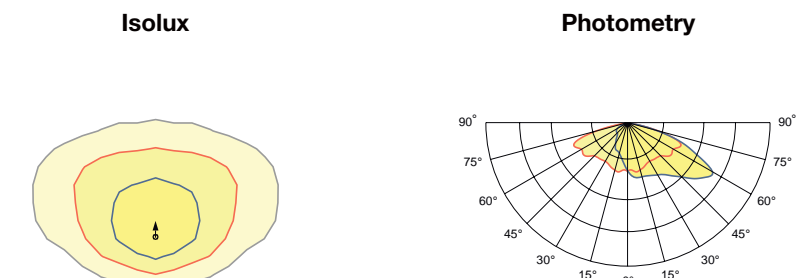

### S07

Ottica asimmetrica per illuminazione stradale, urbana e aree verdi.

*Asymmetrical optic for street, urban and green areas lighting.*

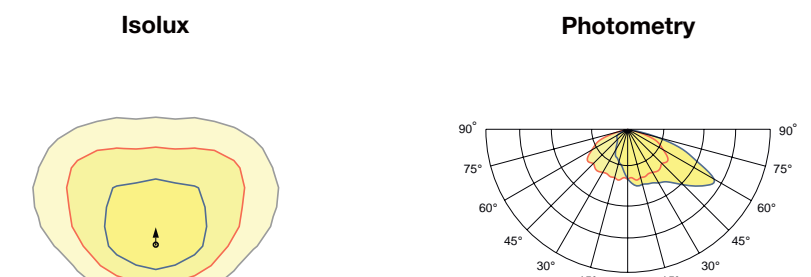

### STA

Ottica asimmetrica per illuminazione di strade larghe urbane e ciclopedonale.

*Asymmetrical optic for large urban and cycle-pedestrian streets lighting.*

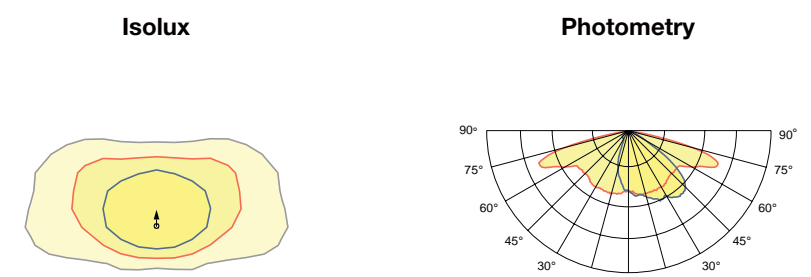



## SV

Ottica asimmetrica per illuminazione di svincoli autostradali o strade urbane molto strette.

*Asymmetrical optic for small urban streets or highway entrance/exit turns.*

Isolux

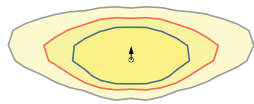

Photometry

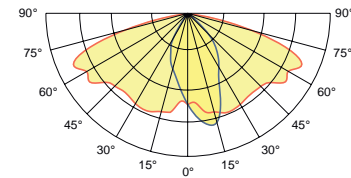

## TS

Ottica simmetrica per illuminazione a centro strada.

*Symmetrical optic for centre road lighting.*

Isolux

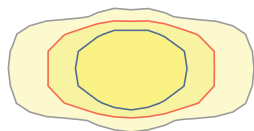

Photometry

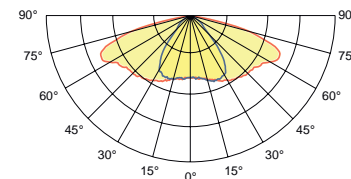

## S

Ottica simmetrica per illuminazione urbana e aree verdi.

*Symmetrical optic for urban lighting and green areas.*

Isolux

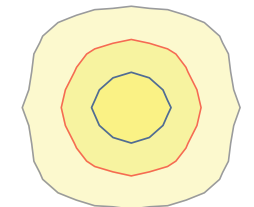

Photometry

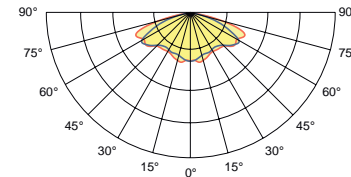

## Temperatura di colore disponibile Available Color temperature

### Temperatura di colore standard

Su tutti i prodotti AEC che supportano la tecnologia ottica Pentha può essere scelta una delle seguenti opzioni monocromatiche CCT: 2200K | 2700K | 3000K | 4000K.

*For all AEC products with Pentha optical technology, it's possible to choose one of the following monochromatic CCTs: 2200K | 2700K | 3000K | 4000K.*

### Tunable White

Tunable White Technology consente di emettere differenti tonalità di luce in un range da 2200K a 3000K. Altre configurazioni su richiesta.

*Tunable White Technology allows to emit different shades of light in a range from 2200K to 3000K. Other configurations on request.*

2200K 2700K 3000K



ILLUMINAZIONE

La ricerca della  
perfezione

The pursuit of perfection



# AEC presenta la nuova ottica per attraversamenti pedonali

AEC presenta la nuova ottica OP specifica per attraversamenti pedonali. La nuova ottica OP è stata nuovamente sviluppata con nuove sorgenti LED. Il nuovo sistema ottico, realizzato in alluminio di altissima qualità, è stato progettato per garantire altissime performance e un maggiore risparmio energetico. La nuova ottica OP, utilizza una nuova tecnologia che richiede un minor flusso luminoso mantenendo invariate le performance e l'efficienza.

# AEC presents the new optic for pedestrian crossings

AEC presents the new OP optic specific for pedestrian crossings. The new OP optics have been developed again with new LED sources. The new optical system, made of the highest quality aluminium, has been designed to guarantee very high performance and greater energy savings. The new OP optic uses a new technology that requires less luminous flux while maintaining performance and efficiency unchanged.





# Le nuove performance

## *The new performance*

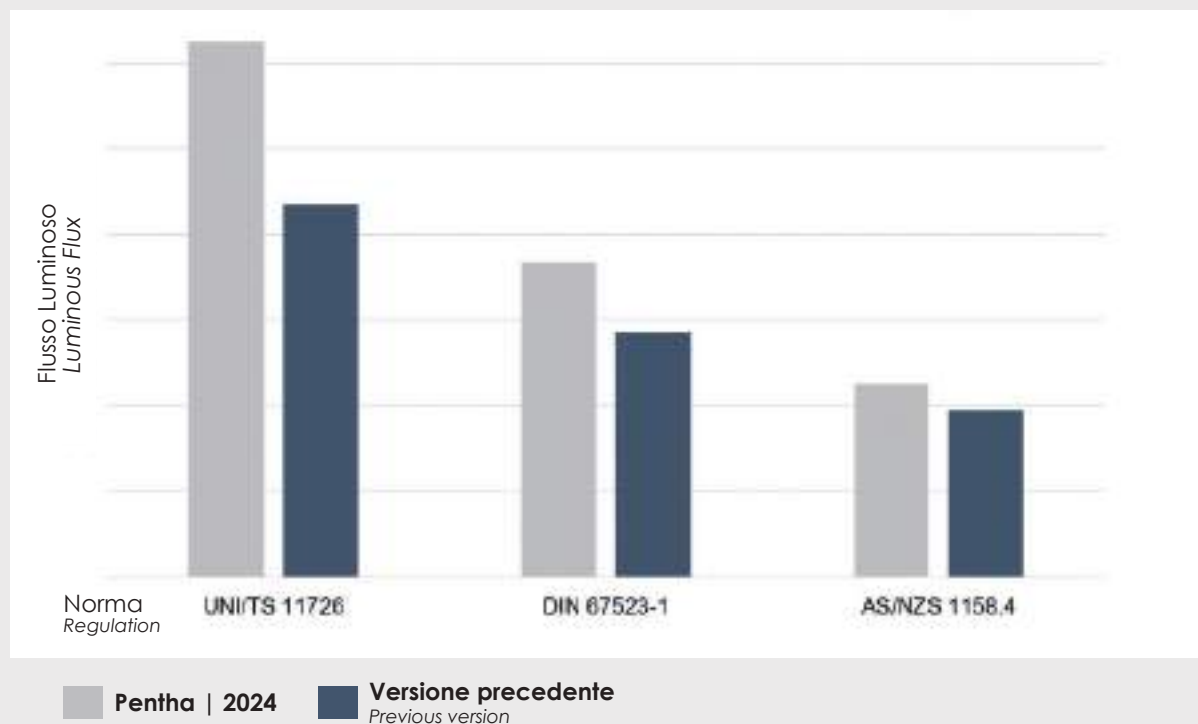

### GRAFICO PERFORMANCE A CONFRONTO

Nuova ottica OP e versione precedente

Il grafico rappresenta 3 esempi di riferimento alle diverse normative:

UNI/TS 11726

DIN 67523-1

AS/NZA 1158.4

### COMPARISON PERFORMANCE GRAPH

New OP optic and previous versions

The graph represents 3 examples of reference to the following different regulations:

UNI/TS 11726

DIN 67523-1

AS/NZA 1158.4





# Ottiche specifiche per attraversamenti pedonali

## Specific optics for pedestrian crossings

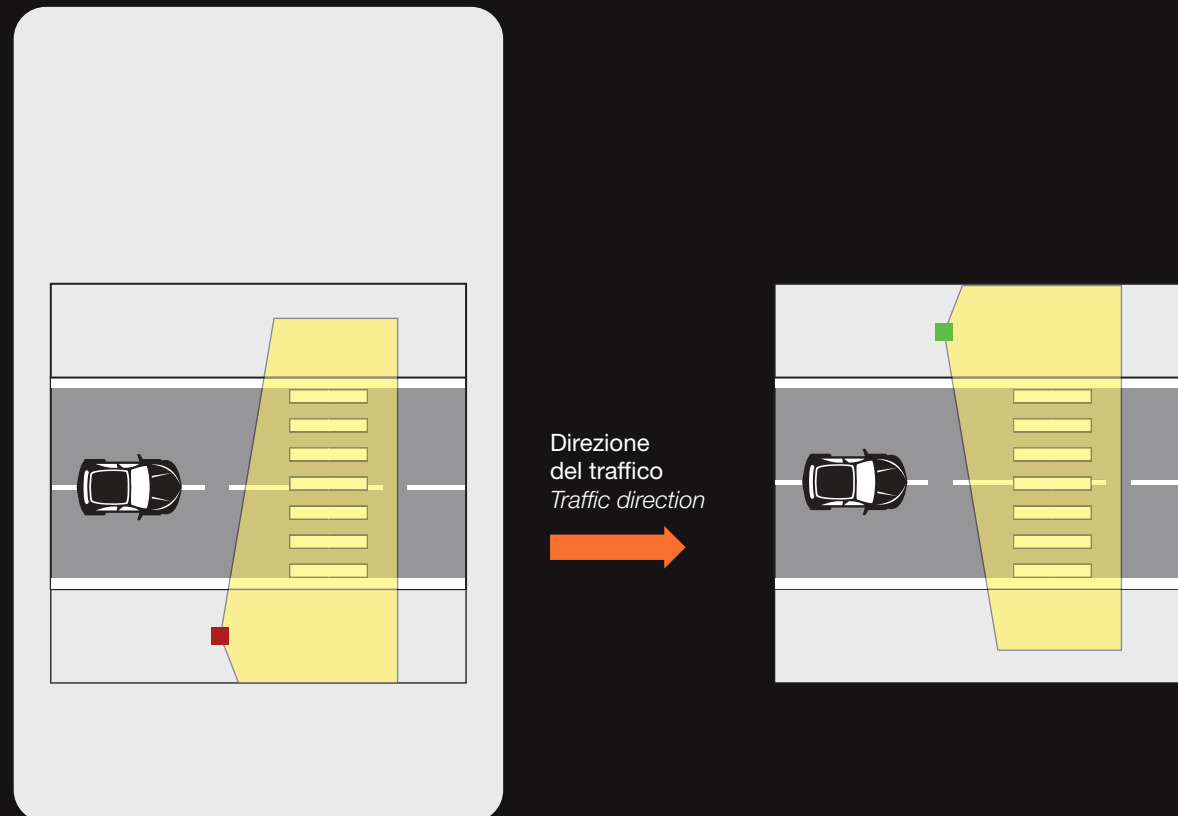

Ottiche OP per evidenziare le zone di attraversamento e garantire il corretto illuminamento verticale richiesto dalla norma UNI/TS 11726.

OP optics to highlight crossing areas and to ensure the correct vertical illuminance required by the standards.

### Criteria di installazione Installation criteria

Strada a senso unico  
One way street

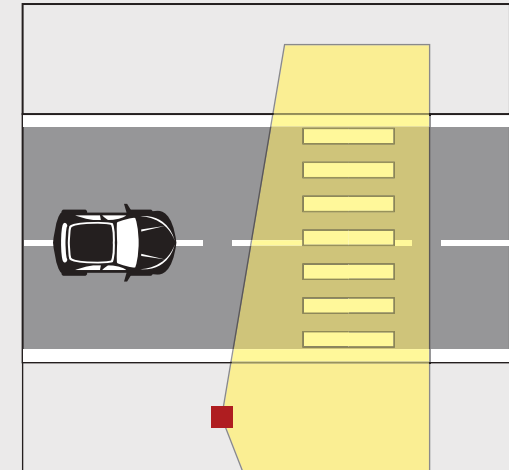

Strada a senso unico con due corsie  
One way street with two lanes

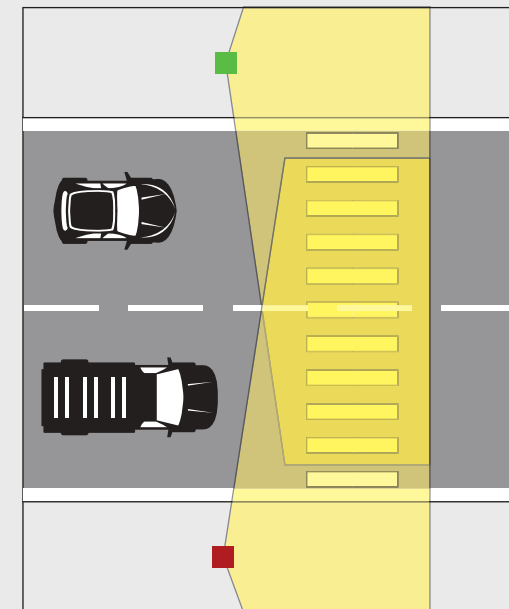

Strada a doppio senso  
Two way street

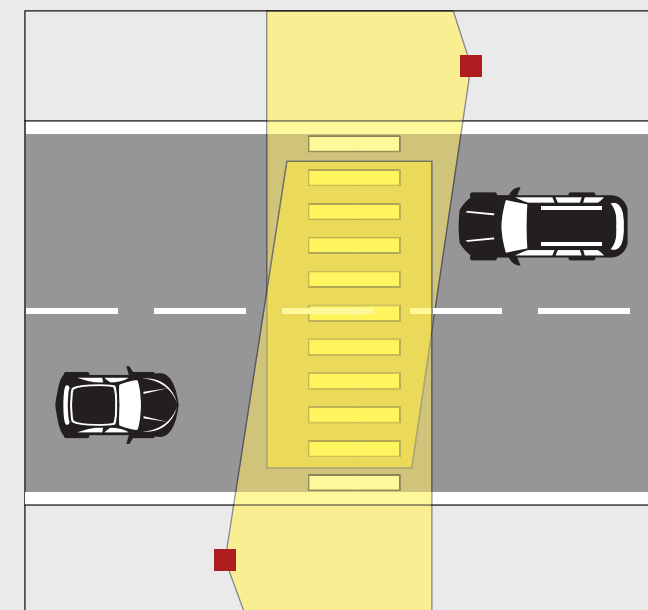



# NEWS 2024

## The new Building

Il progresso guarda  
in una sola direzione



Durante il 2024 AEC inaugurerà ufficialmente il nuovo reparto Logistic & Assembly. Al suo interno si trovano 2 magazzini automatizzati che aumenteranno la capacità di stoccaggio fino a 27.000 pallets. Con il nuovo plant, AEC si estende in una superficie totale 126.000 mq, di cui coperti 52.000 mq.



## *Progress looks in one direction only*

*During 2024 AEC will officially inaugurate the new Logistic & Assembly Center: the new plant dedicated to logistics and assembly. There are 2 new automated warehouses inside it, which will increase the storage capacity for a total of 27,000 pallets. With the new plant, AEC extends over a total area of 126.000 square meter, of which 52.000 square meter are covered.*



Il servizio clienti è la chiave del nostro successo

*Customer service is the key of our success*

AEC ha ampliato la capacità di stoccaggio e implementato il servizio **STOCK VERSION** che garantisce prodotti stock in pronta consegna.

*AEC has expanded the storage capacity and implemented the **STOCK VERSION** service, which guarantees products in stock ready for delivery.*

STOCK  
service

## Prodotti STOCK VERSION

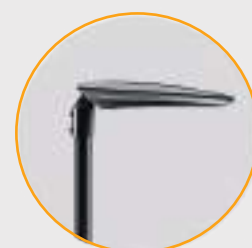

ITALO

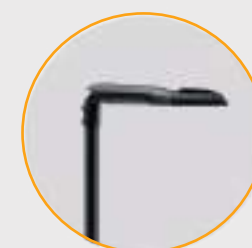

I-TRON



Q-DROME



ARYA

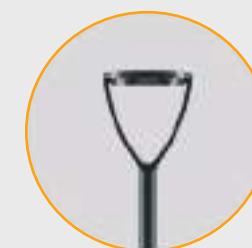

ECORAYS



MX PRO 1



MX PRO 2

## Contacts

Ufficio commerciale AEC  
AEC Sales Office



IT: [commerciale@aecilluminazione.it](mailto:commerciale@aecilluminazione.it)  
Foreign: [orders@aecilluminazione.it](mailto:orders@aecilluminazione.it)

Agenzie Italia AEC  
AEC Italian Distributors



ILLUMINAZIONE



# Tecnologia Solare

## *Solar Technology*

L'illuminazione pubblica è uno dei settori più importanti in cui la tecnologia solare può essere applicata. I corpi illuminanti dotati di tecnologia solare rappresentano una soluzione sostenibile ed efficace per contribuire alla salvaguardia dell'ambiente e alla riduzione di emissioni di carbonio.

AEC Illuminazione sta dedicando importanti investimenti in questa tecnologia in quanto rappresenta una fonte pulita e rinnovabile.

I corpi illuminanti con tecnologia solare sono affidabili, duraturi e possono produrre energia per decenni, con un investimento iniziale che si ripaga nel tempo. La tecnologia solare applicata alla pubblica illuminazione richiede un'inferiore manutenzione in quanto non necessita di cavi elettrici o contatori e questo consente di ridurre notevolmente i costi dell'impianto.

La filosofia aziendale di AEC Illuminazione promuove una cultura orientata verso un equilibrio aziendale sempre più sostenibile. Essere un'azienda sostenibile rappresenta per AEC un fattore di rilevanza del proprio processo di sviluppo e del miglioramento delle performance aziendali: un elemento imprescindibile del suo core business. Da questo nasce la volontà di AEC di investire nella tecnologia solare progettando nuove soluzioni per illuminazione stradale e urbana.

## A pieno ritmo verso soluzioni che utilizzano energia rinnovabile



*Public lighting is one of the most important sectors where solar technology can be applied. Lighting fixtures equipped with solar technology represent a sustainable and effective solution to contribute to protecting the environment and reducing carbon emissions.*

*AEC Illuminazione is dedicating important investments in this technology as it represents a clean and renewable source.*

*Lighting fixtures with solar technology are reliable, long-lasting and can produce energy for decades, with an initial investment that pays for itself over time. Solar technology applied to public lighting requires less maintenance as it does not need electrical cables or meters and this allows the costs of the system to be significantly reduced.*

*AEC Illuminazione's corporate philosophy promotes a culture oriented towards an increasingly sustainable corporate balance. Being a sustainable company represents for AEC an important factor in its development process and in the improvement of performance: an essential element of its core business. From this arises AEC's desire to invest in solar technology by designing new solutions for street and urban lighting.*

## *At full speed towards renewable energy solutions*



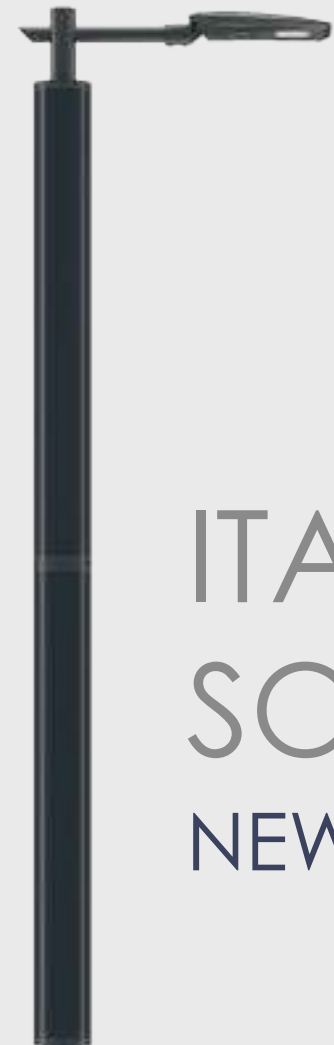

ITALO  
SOLAR  
NEWS 2024



I-TRON  
SOLAR  
NEWS 2024



SOLAR





Dragon Solar

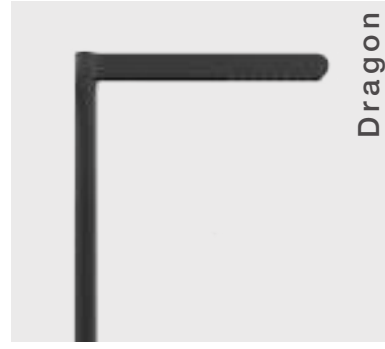

Dragon



NOOS

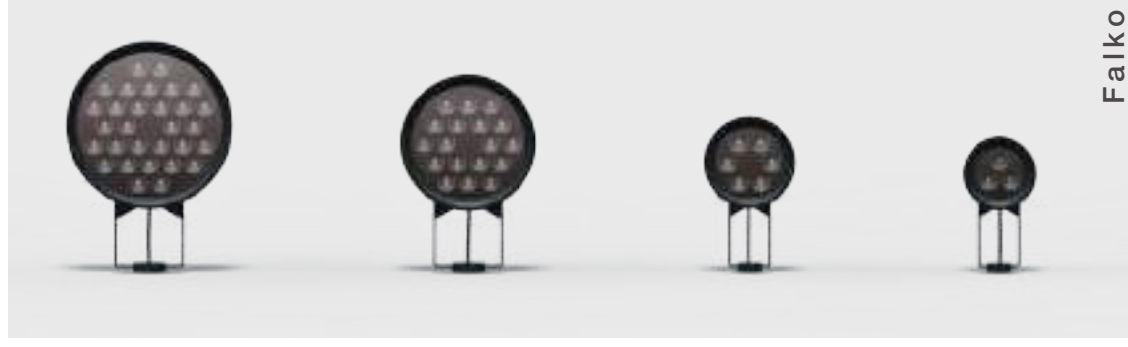

Falko



I-TRON SOLAR

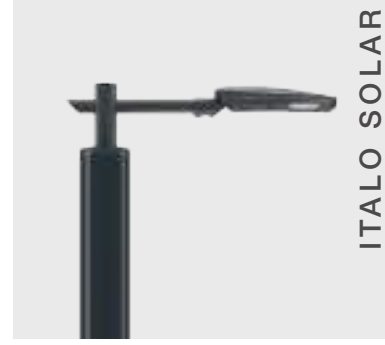

ITALO SOLAR



I-TRON Micro



ITALO RESTYLING



MX PRO 1



MX PRO 2

# NEWS 2024







# Dragon Solar

**The power of nature**

***Sustainable First***

**Progettato con tecnologia solare ibrida, Dragon Solar soddisfa le esigenze di massimo efficientamento energetico e rispetto del pianeta.**

*Designed with solar technology, Dragon Solar satisfies the needs of maximum energy efficiency and respect for the planet.*

Designed by Davide Oppizzi  
**DCUBE.SWISS**

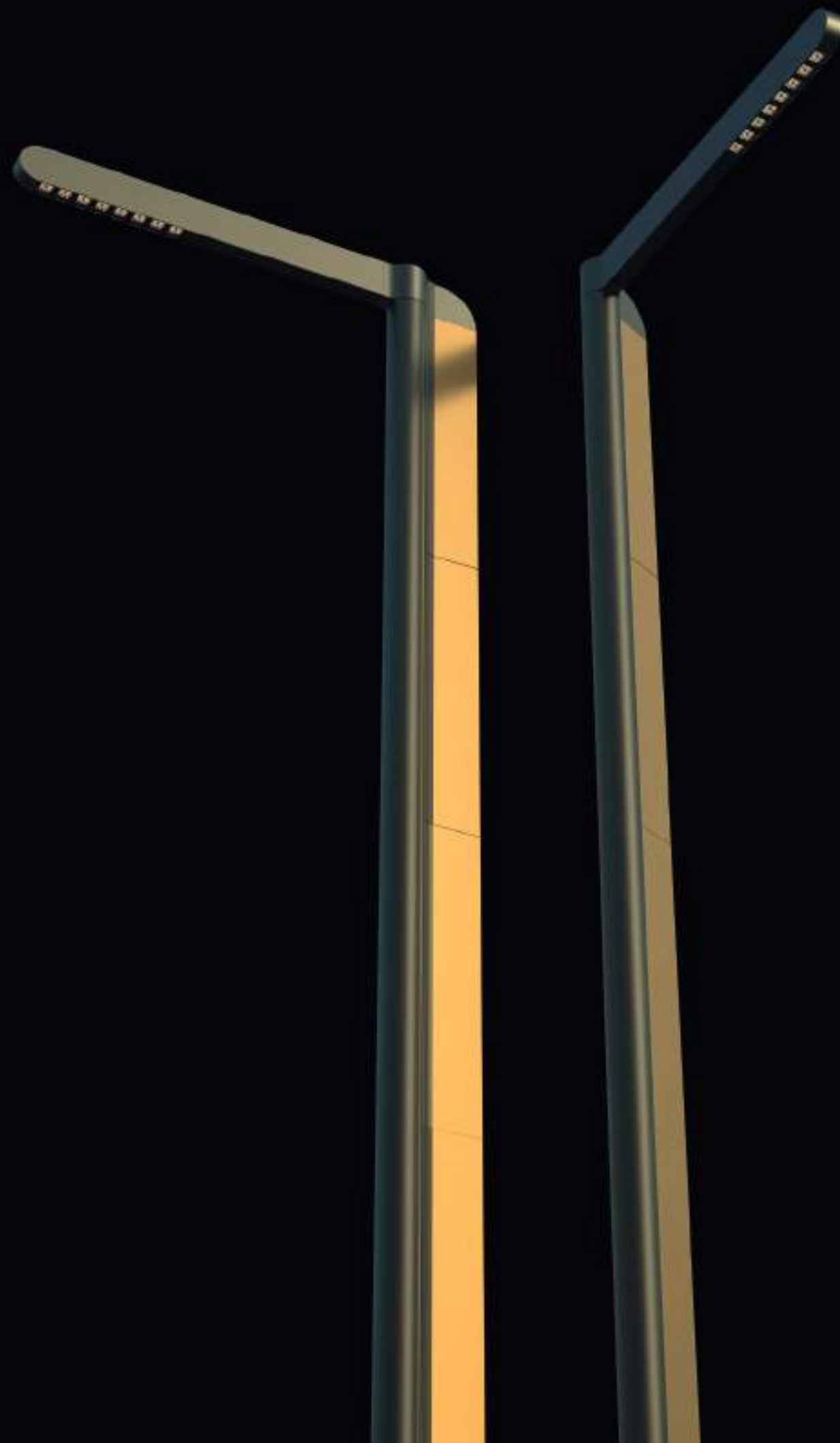





Designed by Davide Oppizzi

**DCUBE.SWISS**



Il progetto DRAGON in collaborazione con Arch. Davide Oppizzi nasce dalla volontà di creare una nuova collezione di corpi illuminanti per illuminazione urbana contraddistinta da stile e minimalismo. Il prodotto è stato pensato come una statua scolpita, elegante e minimale. Un prodotto dove ogni minimo dettaglio comunica con l'ambiente circostante donando uniformità e armonia. Il suo desiderio è stato quello di progettare una tecnologia ottica unica nel suo genere, capace anche di soddisfare i più severi requisiti sull'inquinamento luminoso. Così, da queste esigenze, Arch. Davide Oppizzi ha disegnato per AEC un prodotto di grande design, pensato soprattutto per ridurre l'impatto ambientale.

*The DRAGON project in collaboration with Arch. Davide Oppizzi was born from the desire to create a new collection of lighting fixtures for urban lighting characterized by style and minimalism. The product was designed as a sculpted, elegant and minimal statue. A product where every little detail communicates with the surrounding environment, giving uniformity and harmony. His desire was to design a unique optical technology, also capable of satisfying the most stringent light pollution requirements. From these needs, Arch. Davide Oppizzi realized a great design product for AEC, designed above all to reduce environmental impact.*



## Celle solari ispirate al morfo blu

### *Solar cell inspired by blue morph*

Il morfo non ha colore. Si tratta di cellule disposte in strati che restituiscono una lunghezza d'onda che l'occhio umano percepisce come blu. Circa il 40% delle emissioni di CO2 del mondo provengono dal consumo energetico delle apparecchiature che utilizziamo negli edifici. Da qui nasce l'idea di creare celle fotovoltaiche ispirate al morfo blu: senza pigmenti, nè stampe digitali o vernice. Le celle solari utilizzate su Dragon Solar nascono dall'idea di non limitare più i pannelli alle coperture degli edifici, bensì rivestire anche facciate, balconi, spazi esterni come parcheggi o apparecchi solari per illuminazione, aumentando così le superfici essenziali per catturare l'energia solare.

*The morpho has no color. These are cells arranged in layers that return a wavelength that the human eye perceives as blue. Around 40% of the world's CO2 emissions come from the energy consumption of the equipment we use in buildings. Hence the idea of creating photovoltaic cells inspired by the blue morpho: without pigments, digital prints or paint. The solar cells used on Dragon Solar were born from the idea of no longer limiting the panels to the roofs of buildings, but also covering facades, balconies, outdoor spaces such as car parks or solar lighting devices, thus increasing the surfaces essential for capturing solar energy.*

## Colori disponibili Available Colors



La particolare colorazione blu di questa farfalla è dovuta alla conformazione superficiale delle sue ali. Le ali di questo lepidottero sono infatti un esempio di materiale gerarchico, il quale attraverso una serie di interferenze, create da una struttura frattale, riesce ad annullare tutte le lunghezze d'onda ad esclusione di quella che consideriamo blu. Questo fenomeno è comune anche ad altri animali ed è pressoché il solo caso in cui è possibile vedere il colore blu in natura, non essendovi pigmenti naturali di tale colore.



Celle Solari  
orientate alle  
esigenze del  
regno animale

*Solar Cells  
oriented to  
the needs of  
animal kingdom*

*The particular blue color of this butterfly is due to the surface shape of its wings. The wings of this moth are in fact an example of hierarchical material, which through a series of interferences, created by a fractal structure, manages to cancel out all wavelengths with the exception of the one we consider blue. This phenomenon is also common to other animals and is almost the only case in which it is possible to see the color blue in nature, as there are no natural pigments of this color.*





**DRAGON**<sup>®</sup>  
SOLAR



AE  
ΦC  
ILLUMINAZIONE



**I suoi moduli solari BIPV sono colorati e rendono invisibile la cella solare.**

*Its colorful BIPV solar modules make the solar cell invisible.*

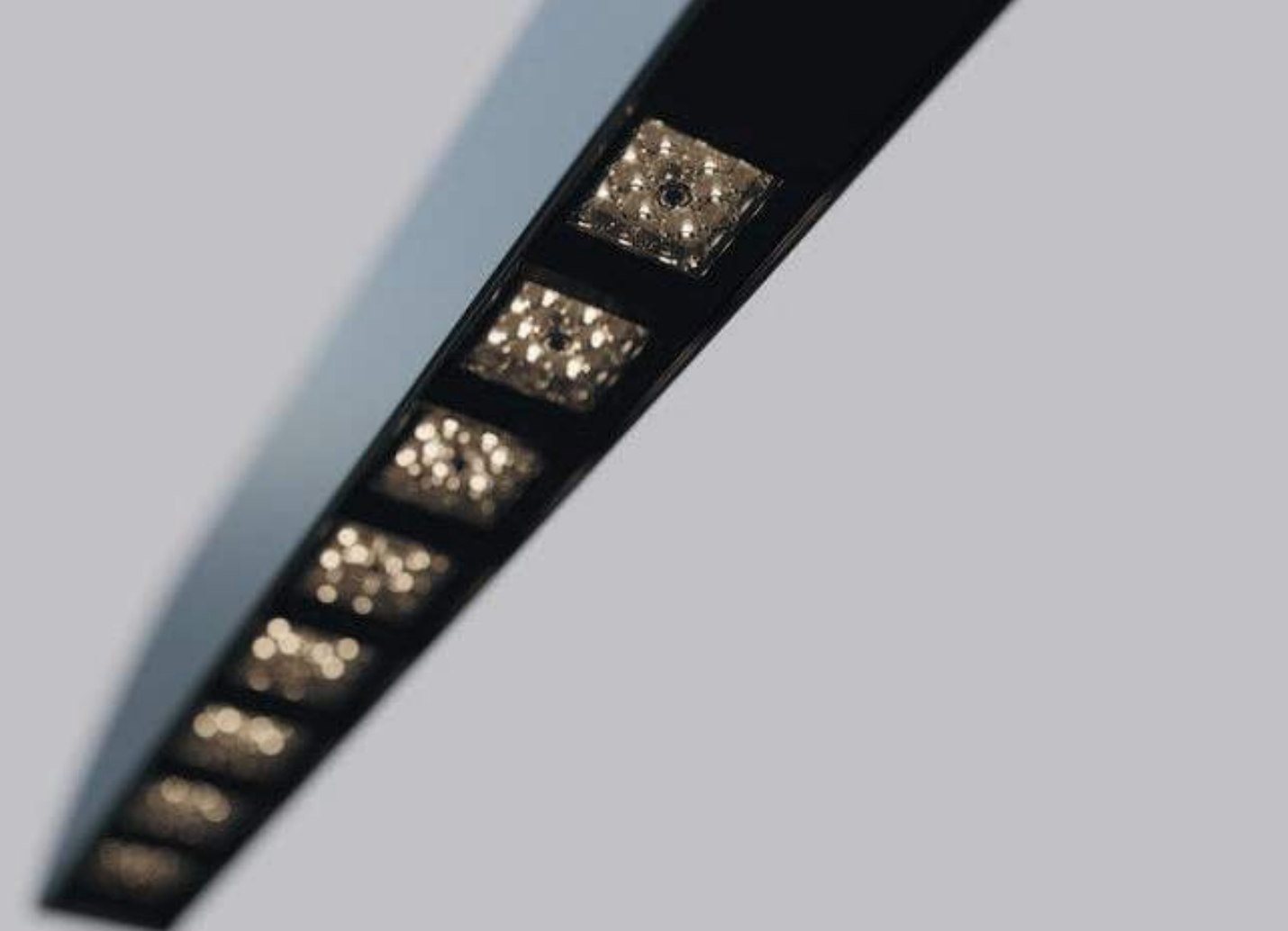

**Celle fotovoltaiche di ultima generazione ad altissime prestazioni.**

*Latest generation and high performance photovoltaic cells.*





H7  
C168.3.C152.7000

H8  
C168.3.C152.8000

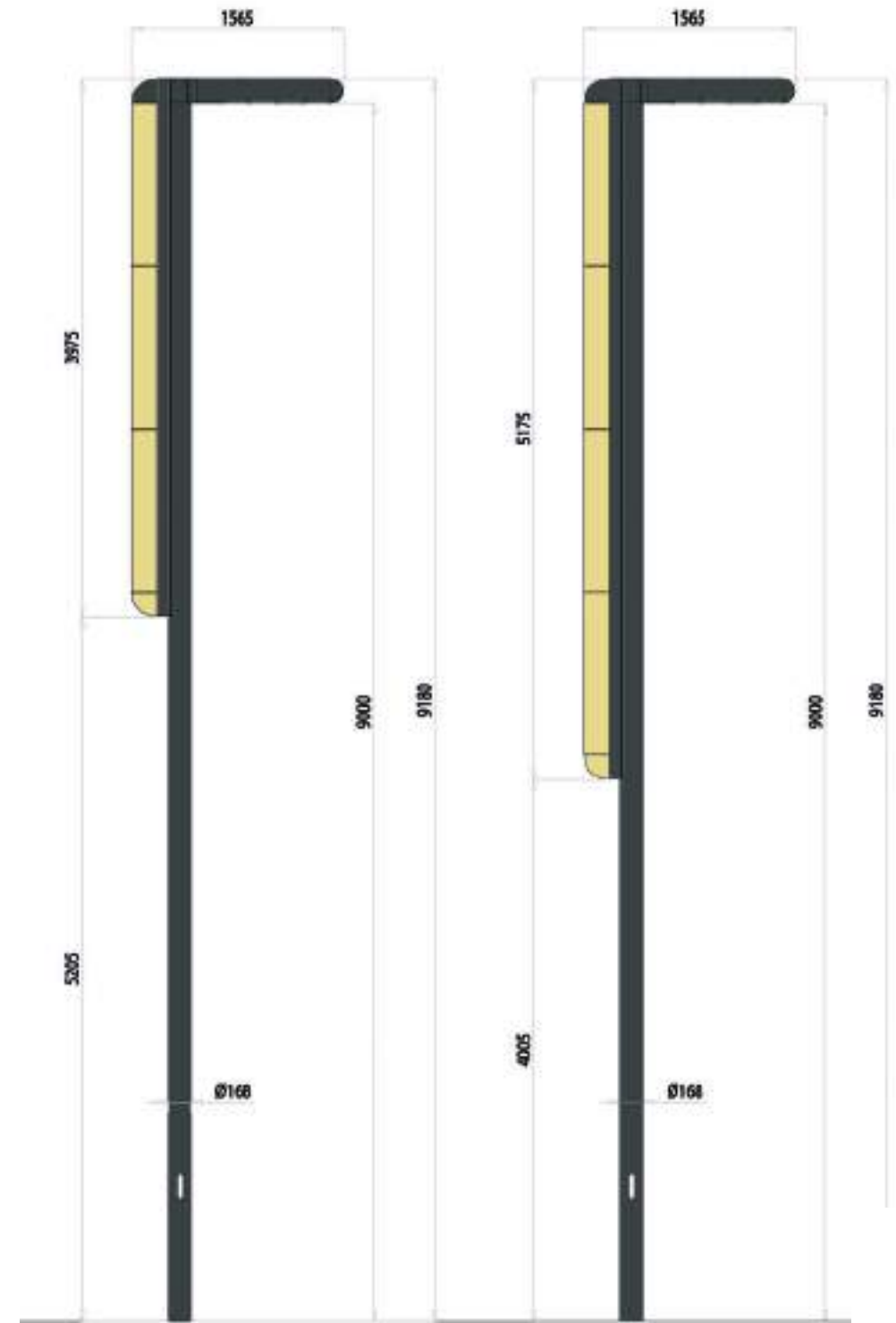

H9  
C168.3.C152.9000

H9  
C168.3.C152.9000





Corpo illuminante disponibile  
in 2 diverse lunghezze: 1 m e 1,5m

Pali disponibili da 7m a 9 m  
Doppio o triplo pannello solare

*Luminaire available in 2 different lengths:  
1m and 1.5m*

*Poles available from 7m to 9m  
Double or triple solar panel installation*





# Dragon

## *Unique elegance*

**Dragon è stato progettato per integrarsi perfettamente nell'ambiente donandogli valore aggiunto. Il suo design minimal ed elegante lo rende perfetto per ambienti urbani, parchi, piazze e centri cittadini.**

*Dragon was designed to integrate perfectly into the environment, giving it added value. Its minimal and elegant design makes it perfect for urban spaces, parks, squares and city centers.*

Designed by Davide Oppizzi  
**DCUBE.SWISS**

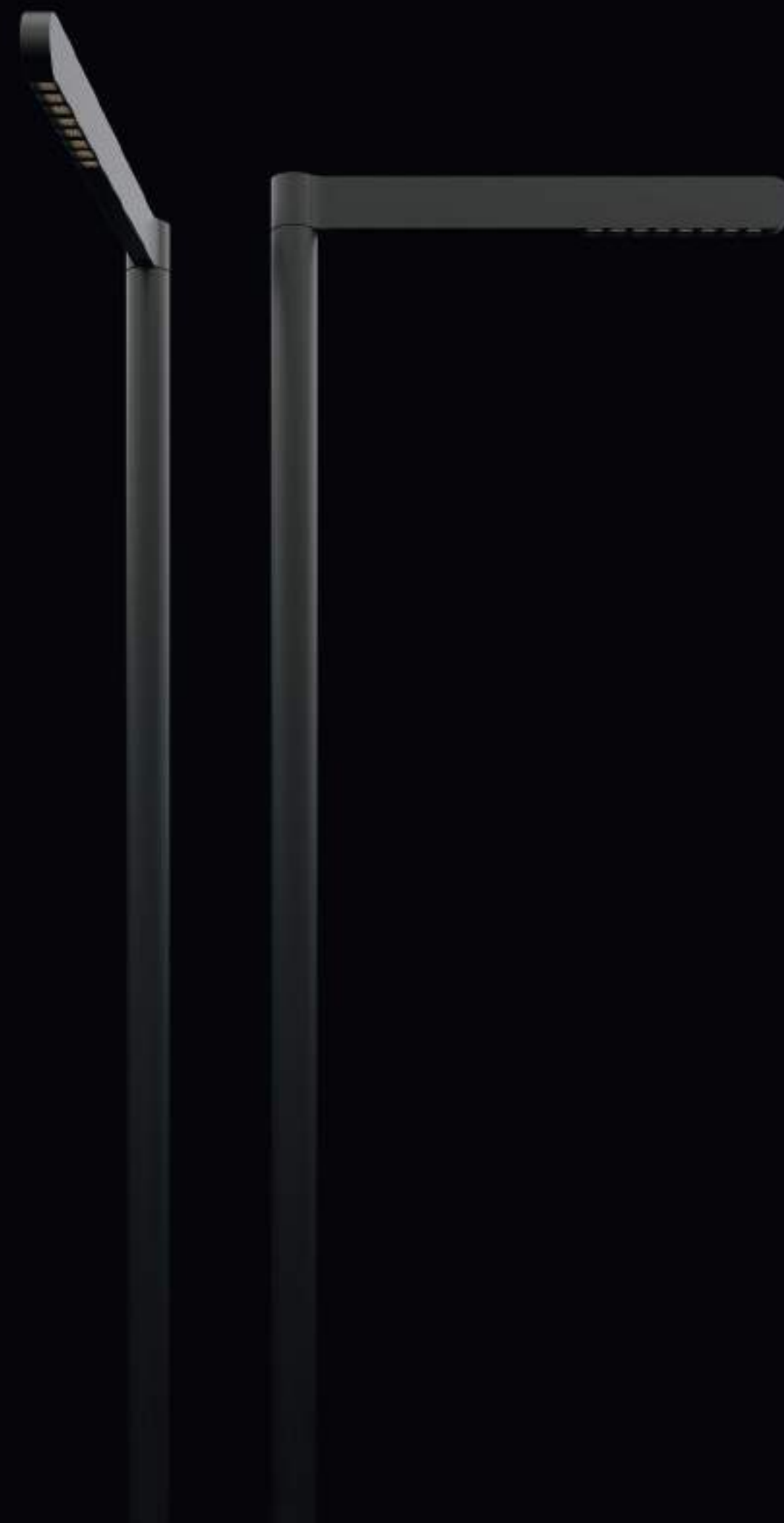





Corpo illuminante disponibile  
in 2 diverse lunghezze: 1m e 1,5m

Pali disponibili da 5m a 8m  
Doppio o triplo pannello solare

*Luminaire available in in 2 different lengths:  
1m and 1.5m*

*Poles available from 5m to 8m  
Double or triple solar panel installation*

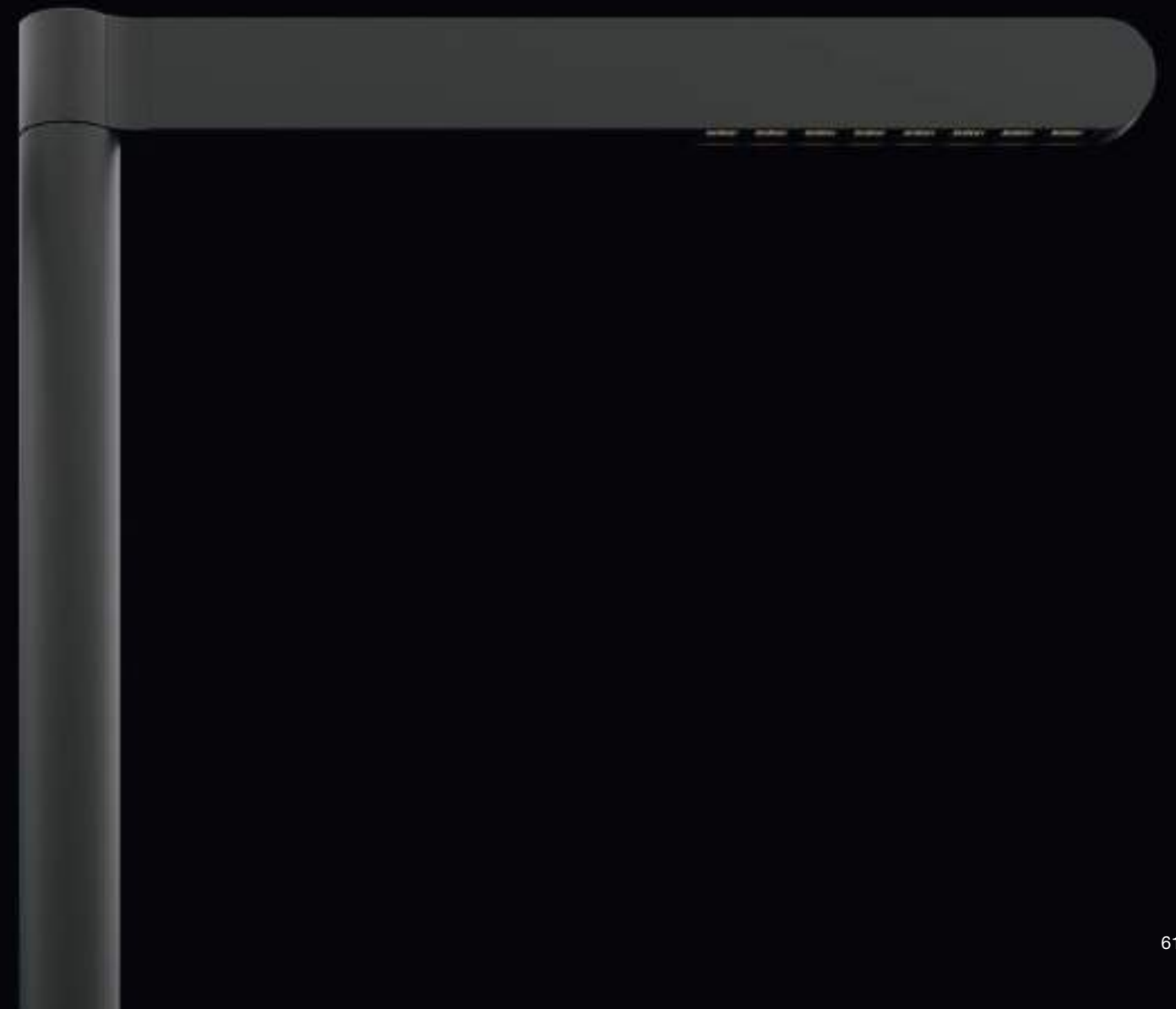



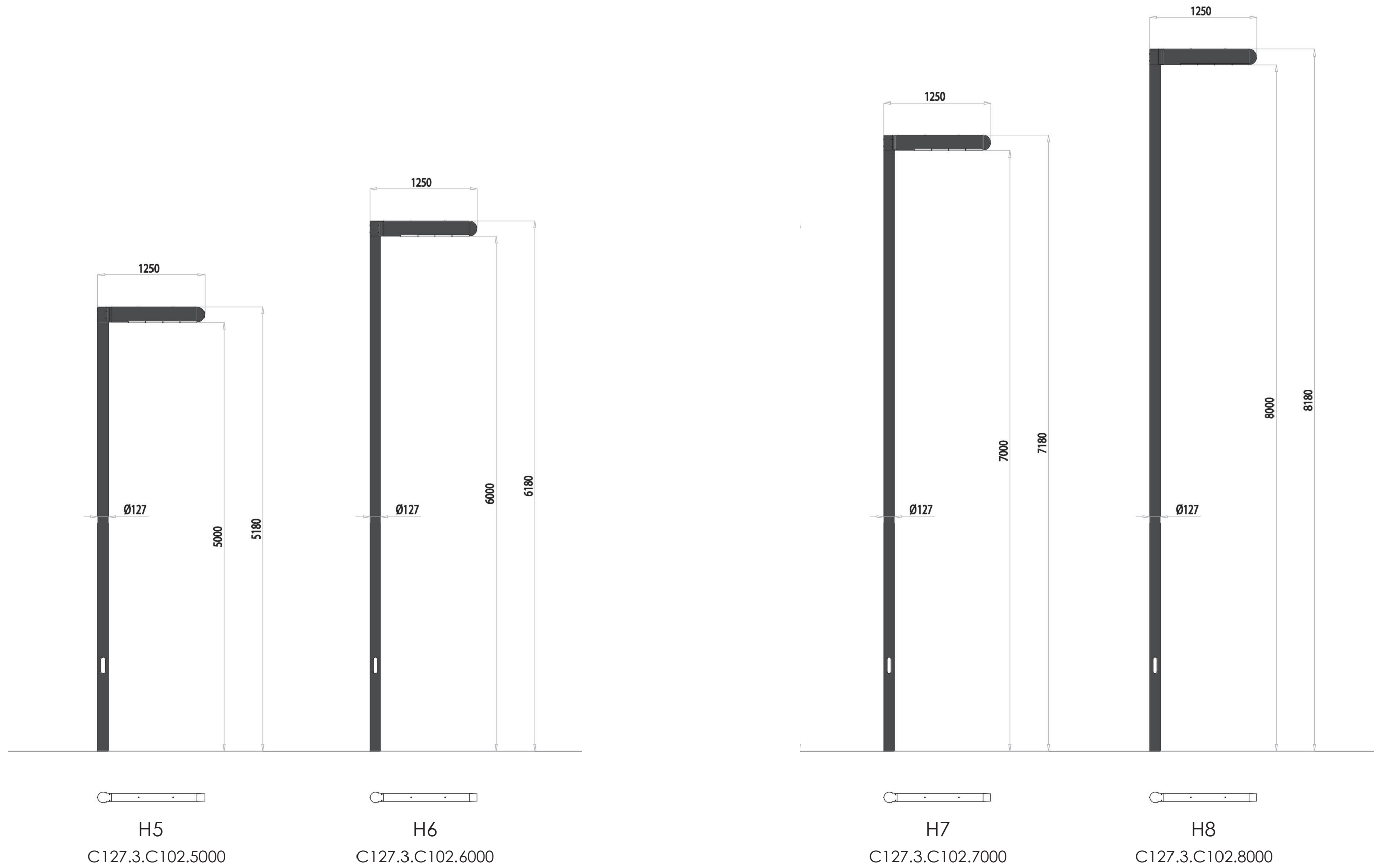





# FALKO

**A E**  
**Φ C**  
ILLUMINAZIONE





# FALKO<sup>®</sup>

*Enhances  
the architecture*



FALKO è la nuova serie di proiettori AEC per illuminazione architettuale, disponibile in 4 dimensioni. La serie, che combina efficacia, performance e un design elegante, è nata per sottolineare architetture ed esaltare gli spazi esterni rispettando la natura e il comfort umano.

*FALKO is the new series of AEC floodlights for architectural lighting, available in 4 sizes. The series, which combines effectiveness, performance and elegant design, has been created to highlight architecture and enhance outdoor spaces while respecting nature and human comfort.*



FALKO 1

Ø 175  
W 21

FALKO 2

Ø 220  
W 42

FALKO 3

Ø 325  
W 121

FALKO 4

Ø 400  
W 200

2200 K Optional  
2700 K  
3000 K  
4000 K

Bianco Dinamico  
Tunable White

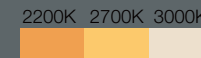

RGB

Colore standard  
Standard Color



Colori optional  
Optional Colors



RAL 6011 Toscana  
RAL 6020 Ottawa  
RAL 7034 Hamptons  
RAL 7022 Davos  
RAL 7032 Jura  
RAL 7003 Island  
RAL 1001 Oman  
RAL 9010 Fiji  
CORTEN Siena

Ottiche  
Optics

|     |        |
|-----|--------|
| RS: | 10°    |
| S:  | 15°    |
| M:  | 26°    |
| W:  | 40°    |
| WW: | 60°    |
| O:  | 16-60° |

Designed by Davide Oppizzi  
**DCUBE.SWISS**



**Colori linea Essential**  
*Essential line colors*



**GRAFITE 01 | ETNA**  
*STANDARD*



**RAL 9010 | FIJI**

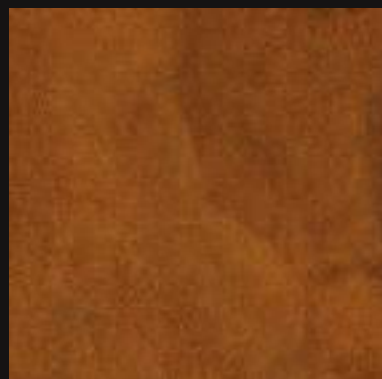

**CORTEN | SIENA**

**GRAFITE AEC 01 STANDARD | ETNA**  
*La pietra di lava*

*AEC STANDARD GRAPHITE 01 | ETNA*  
*The lava stone*

**BIANCO 9010 | FIJI**  
*Sabbia calda chiara*

*WHITE 9010 | FIJI*  
*Light warm sand*

**CORTEN AEC | SIENA**  
*Colore tipico dell'omonima città*

*AEC CORTEN | SIENA*  
*The typical color of the tuscan city*

Minimal. Elegant. Superior.





# Ground line



## Colori linea Terra

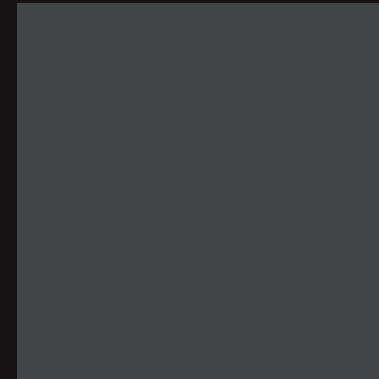

**RAL 7022 | DAVOS**



**RAL 7034 | HAMPTONS**



**RAL 1001 | OMAN**

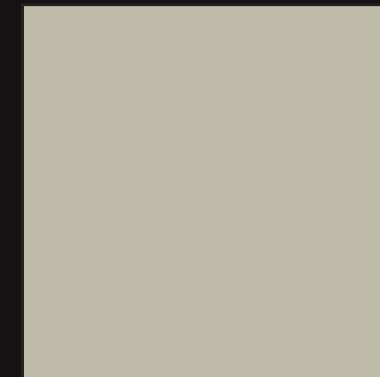

**RAL 7032 | JURA**

**TERRA RAL 1001 | OMAN**  
La sabbia del deserto

*EARTH RAL 1001 | OMAN*  
*Desert sand*

**TERRA RAL 7032 | JURA**  
Pietra grigia chiara calda dello Jura Svizzero

*EARTH RAL 7032 | JURA*  
*Light grey warm stone from the Swiss Jura*

**TERRA RAL 7022 | DAVOS**  
Pietra scura grigia delle montagne Grigioni

*EARTH RAL 7022 | DAVOS*  
*Dark grey stone from the Grisons mountains*

**TERRA RAL 7034 | HAMPTONS**  
L'atmosfera delle hamptons USA  
tra sabbia scura grigia dell'oceano,  
il legno e la vegetazione

*EARTH RAL 7034 | HAMPTONS*  
*The atmosphere of the Hamptons USA among dark  
grey sand of the ocean, wood and vegetation*





# Leaf line



## Colori linea foglia



**RAL 6011 | TOSCANA**

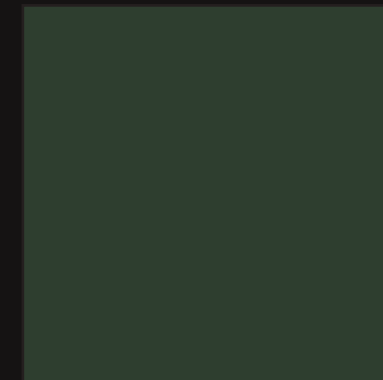

**RAL 6020 | OTTAWA**



**RAL 7003 | ISLAND**

**VERDE SCURO RAL 6020 | OTTAWA**  
Le grandi foreste verde scuro dei pini del Canada

*DARK GREEN RAL 6020 | OTTAWA*  
*The large dark green pine forests of Canada*

**VERDE CHIARO RAL 6011 | TOSCANA**  
I colori più teneri delle foglie e la vegetazione del Sud Europa

*LIGHT GREEN RAL 6011 | TUSCANY*  
*The softest colors of the leaves and vegetation of Southern Europe*

**VERDE MARRONE RAL 7003 | ISLAND**  
I colori della vegetazione Humus del nord

*GREEN BROWN RAL 7003 | ISLAND*  
*The colors of the humus vegetation of the north*





# FALCO

*4 superior design floodlights*



Designed by Davide Oppizzi  
**DCUBE.SWISS**





# FALKO TREE

**Una serie di pali dedicati rende possibile la composizione multipla per soddisfare installazioni architettoniche di particolare rilievo.**

*A series of dedicated poles make possible multiple compositions to satisfy particularly important architectural installations.*



# FALKO TREE

**Attacco su palo diretto  
alla staffa con braccetto**

*Pole fixing directed  
to the bracket*





# FALKO

**FALKO è un sistema che soddisfa ampie esigenze di installazione grazie ai suoi specifici sistemi di ottimizzazione dei fasci luminosi tramite appositi schermi e filtri di correzione della temperatura colore.**

*FALKO is a system that satisfies a lot of installation needs due to its optimization systems of the light beams via special screens and color temperature correction filters.*



# X-FORM Pole Systems



Cylindrical  
Section

Conical  
Section

Cylindrical  
Section



## PALI X-FORM

**Pali multisezione laminati HSP  
in acciaio S 275 JRM (FE 430) serie X-FORM.  
Sezione cilindrica e conica disegnati per essere integrati  
in contesti architettonici di particolare rilievo.**

*HSP laminated multi-section steel poles  
in S 275 JRM (FE 430) X-FORM series.  
Cylindrical and conical section designed to be integrated  
in architectural contexts of particular importance.*

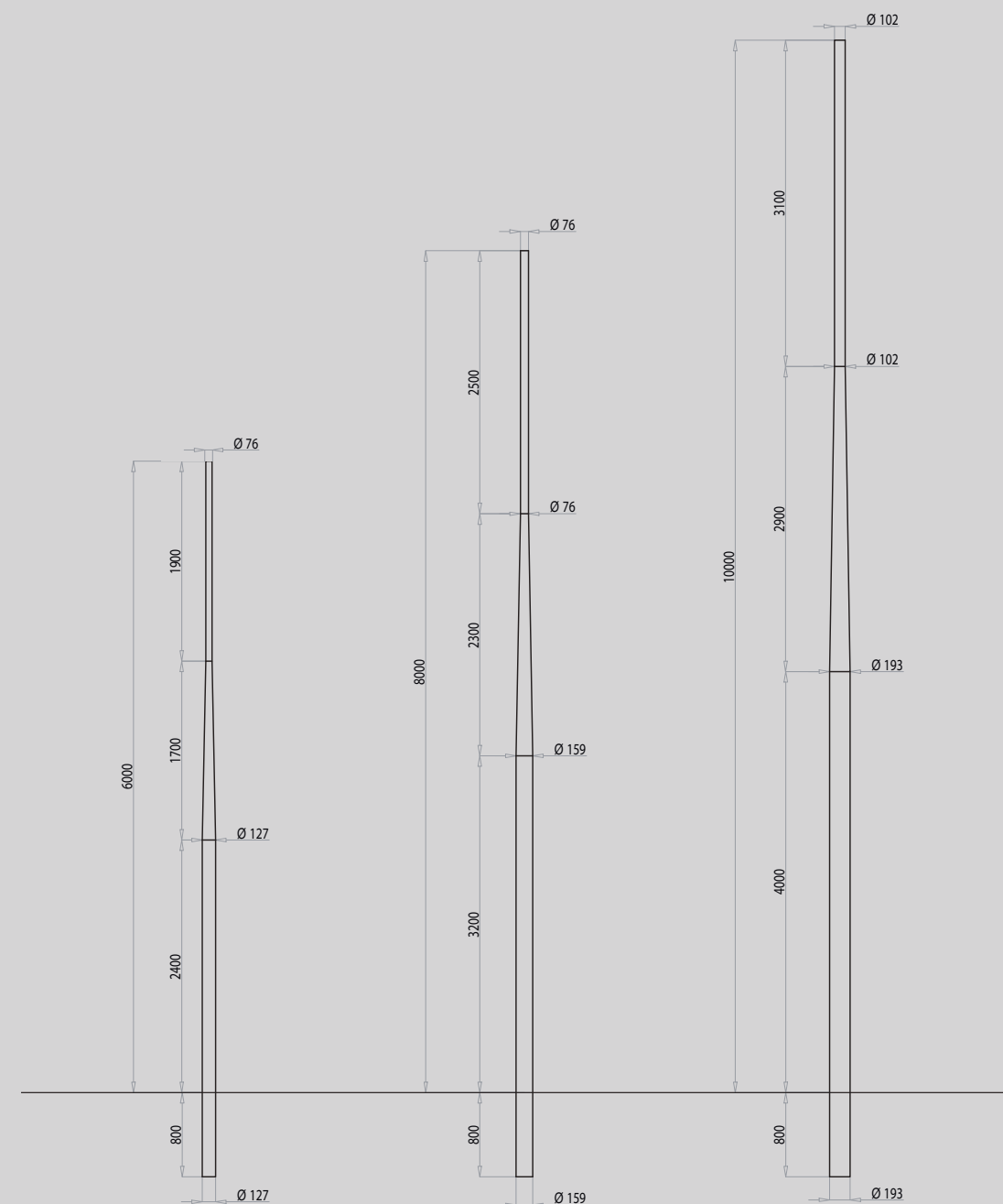

|       | X-FORM 6 | X-FORM 8 | X-FORM 10 |
|-------|----------|----------|-----------|
| FIT.  | 6000 mm  | 8000 mm  | 10000 mm  |
| TOT   | 6800 mm  | 8800 mm  | 10800 mm  |
| BASE  | Ø127 mm  | Ø152 mm  | Ø193 mm   |
| TESTA | Ø76 mm   | Ø102 mm  | Ø102 mm   |



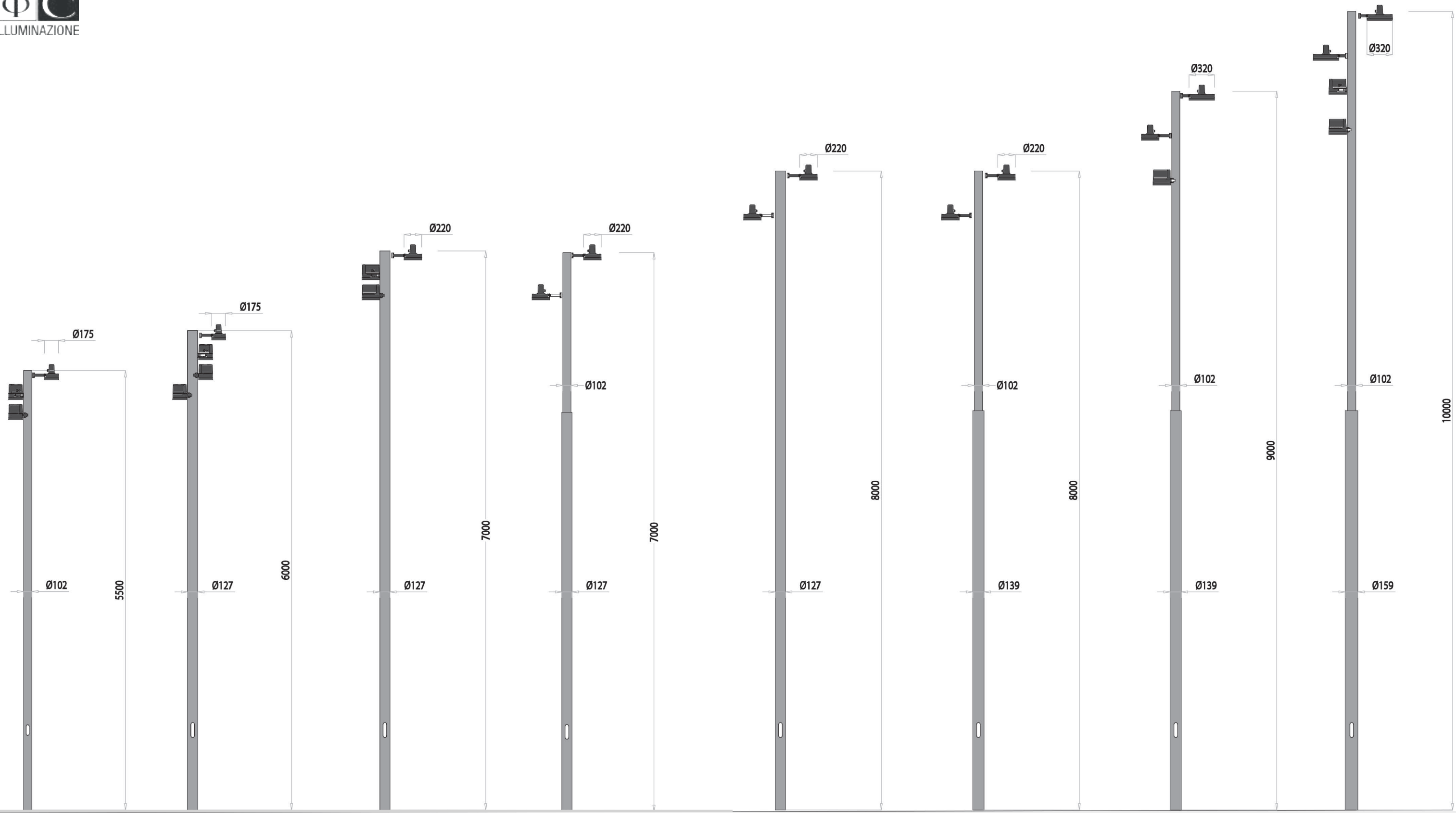

H5.5 C.102.3.5500    H6 C.127.3.6000    H7 C.127.3.7000    H7 C.127.3.102.3.7000    H8 C.127.3.8000    H8 C.139.3.102.8000    H9 C.139.3.102.3.9000    H10 C.159.3.102.3.10000



AE  
ΦC  
ILLUMINAZIONE



Designed by Davide Oppizzi  
**DCUBE.SWISS**

ALFA





AE  
ΦC  
ILLUMINAZIONE



Designed by Davide Oppizzi  
**DCUBE.SWISS**

2  
O  
K  
A  
E





AE  
ΦC  
ILLUMINAZIONE



Designed by Davide Oppizzi  
**DCUBE.SWISS**

3  
O  
K  
L  
A  
E





AE  
ΦC  
ILLUMINAZIONE



Designed by Davide Oppizzi  
**DCUBE.SWISS**

4  
O  
K  
A  
E





# NOOS

Arch. Massimo Sacconi  
Arch. Marzia Bandini  
Studio Id design



**NOOS è una serie composta da due versioni, pensata per ambienti urbani. Il prodotto è stato disegnato con linee morbide e minimaliste per creare spazi pubblici inclusivi evidenziando la particolarità di un luogo. Una serie ispirata a forme classiche che personalizza le architetture degli ambienti.**

*NOOS is a series composed of two versions, designed for urban environments. The product was designed with soft and minimalist lines to create inclusive public spaces highlighting the particularity of a place. A series inspired by classic shapes that personalizes the architecture of the environments.*



# NOOS

*New urban lighting product*



**Il nuovo inconfondibile  
prodotto firmato AEC  
per arredo urbano**

*The new product  
for urban lighting*

**La serie è disponibile in due dimensioni: Noos 1 e Noos 2**

*The series is available in two dimensions: Noos 1 and Noos 2*

## NOOS 1



## NOOS 2







**La sua forma minimalista e distintiva rende la serie adatta ad un'ampia varietà di applicazioni urbane. NOOS, dotato di ottica Pentha, garantisce un'illuminazione armoniosa ed efficiente in ogni contesto urbano: strade residenziali, zone pedonali, parchi e piazze.**

*Its minimalist and distinctive shape makes the series suitable for a wide variety of urban applications. NOOS, equipped with Pentha optic, guarantees harmonious and efficient lighting in every urban context: residential streets, pedestrian areas, parks and squares.*

# NOOS



**Dimensioni**  
Dimensions

**NOOS 1**

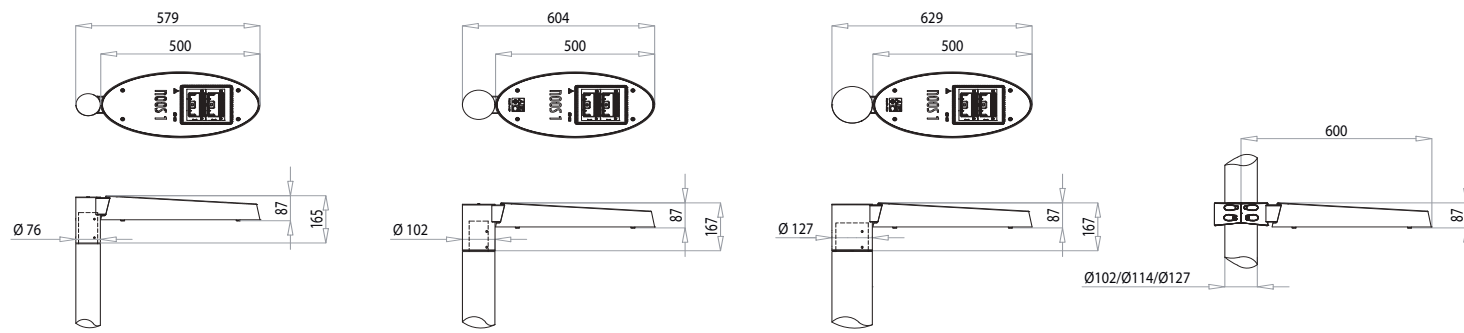

**NOOS 1 BR-L**

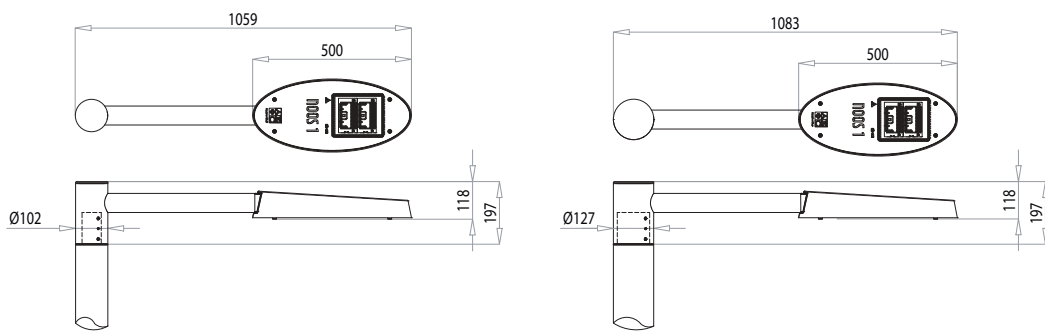

**NOOS 2**

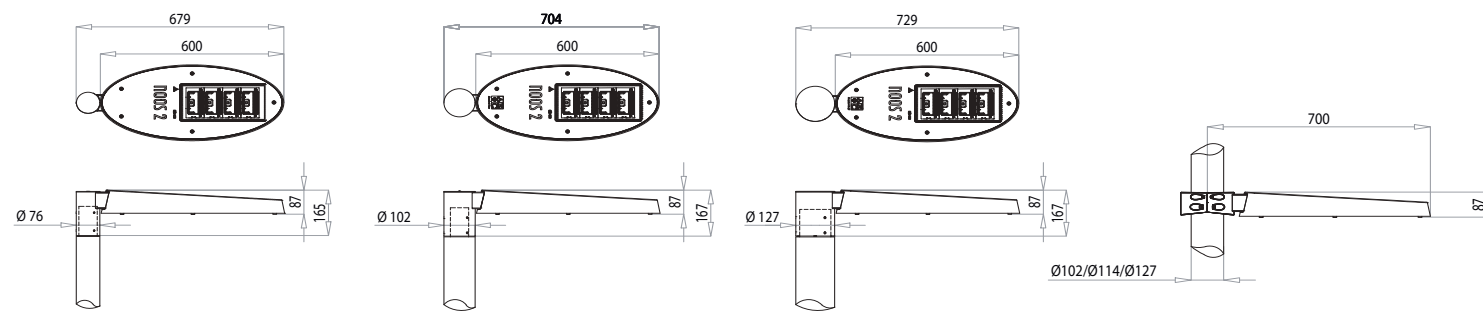

**NOOS 2 BR-L**

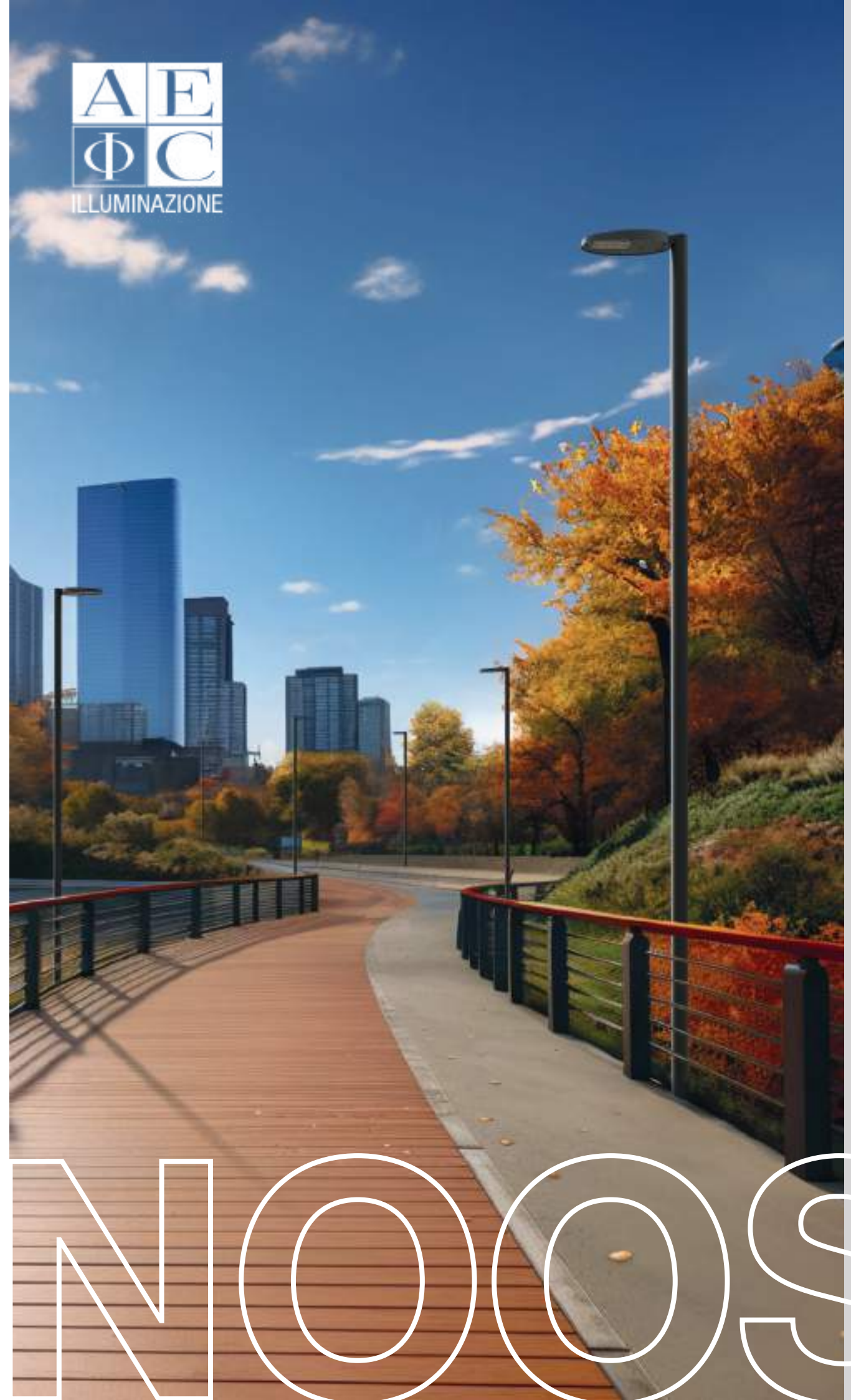
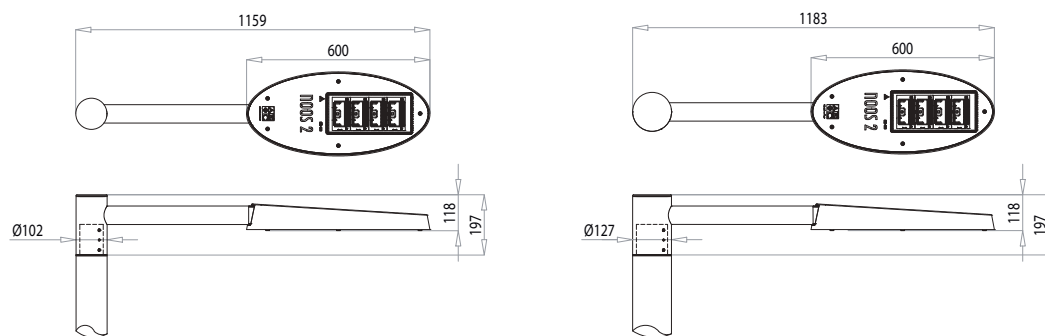

NOOS

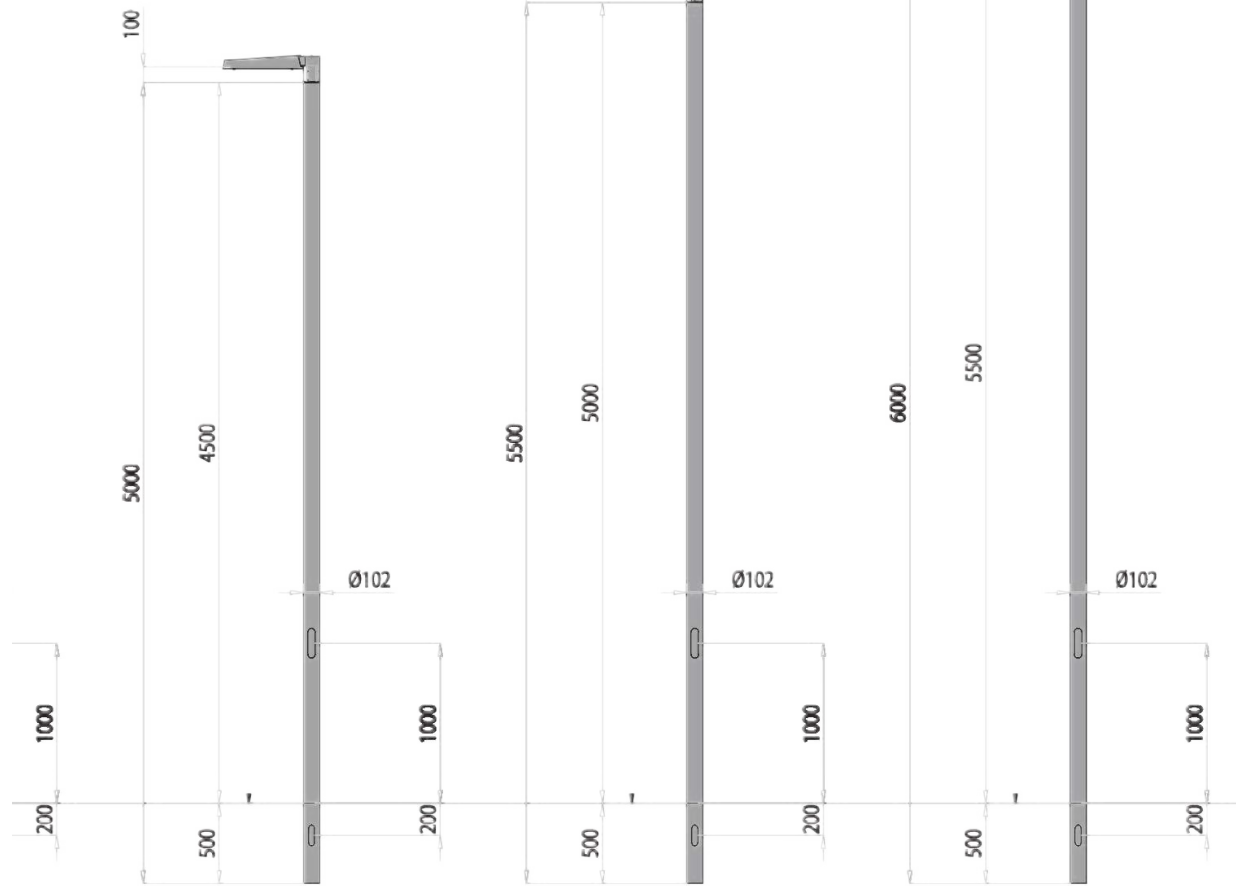

H5  
 C.102.3.C.60.5000  
 C.102.3.C.60.4500  
 C.102.3.C.60.4000

H5  
 C.102.3.C.60.5500

H6  
 C.102.3.C.60.6000

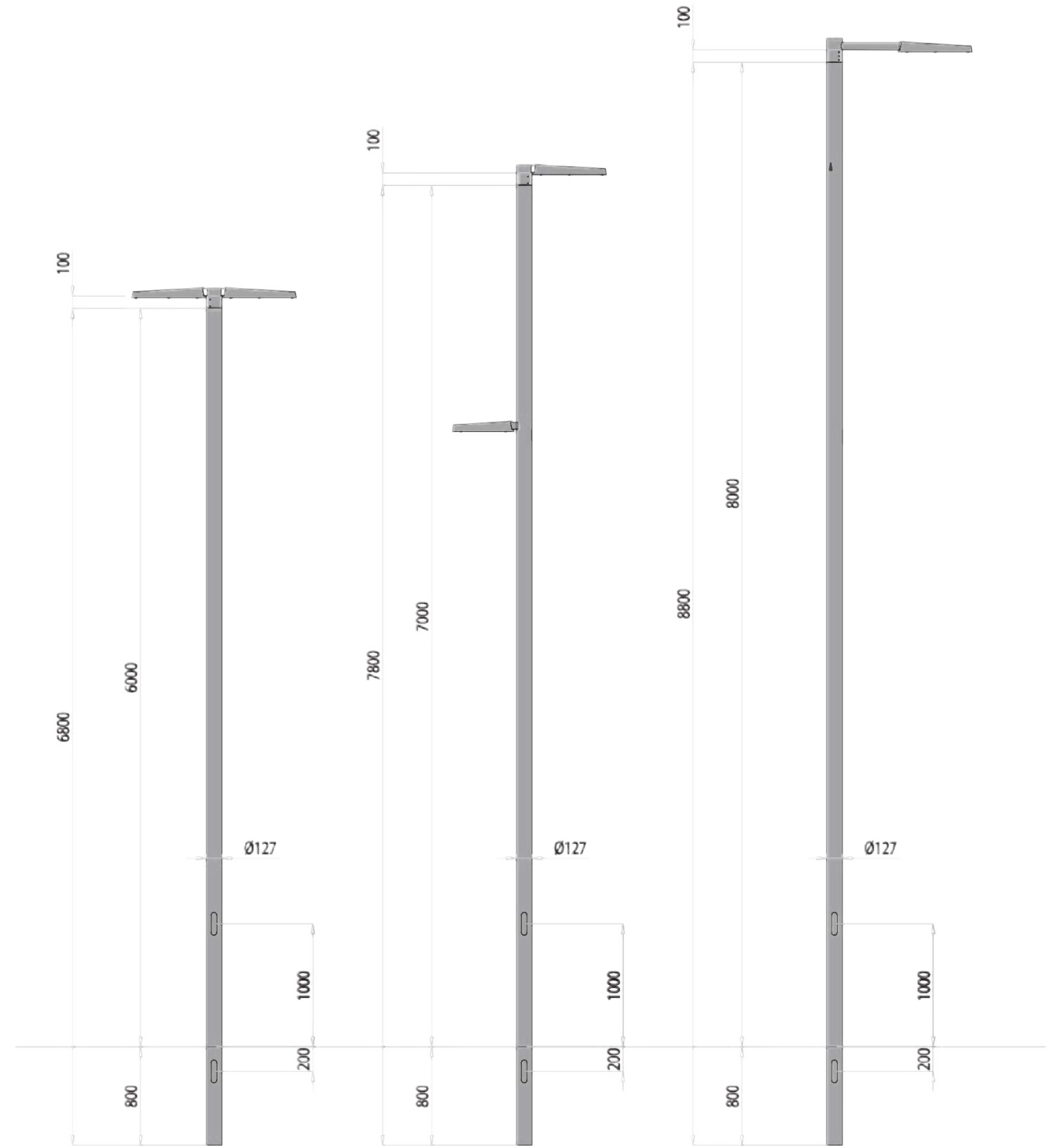

H6  
 C.127.3.C.102.6000

H7  
 C.127.3.C.102.7000

H8  
 C.127.3.C.102.8000



# MX PRO

***A series for floodlighting***

**MX PRO è una nuova serie di proiettori composta da due versioni, progettata per illuminazione di piccole e grandi aree, infrastrutture, impianti sportivi e tunnel.**

*MX PRO is a new series of floodlights consisting of two versions, designed for small and large areas lighting, infrastructures, sports facilities and tunnels.*



# MX PRO

Designer Massimo Sacconi

MX PRO 1  
4 moduli LED  
4 LED modules



MX PRO 2  
9 moduli LED  
9 LED modules



# MX PRO





**Massima potenza ed efficienza**  
**Maximum performance and efficiency**

**Dimensioni**  
*Dimensions*

**MX PRO 1**

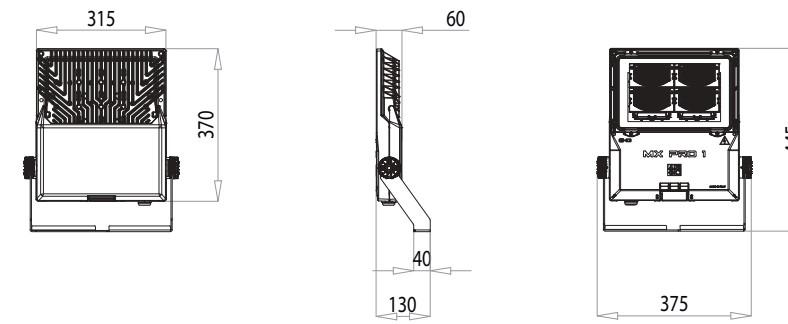

**MX PRO 2**

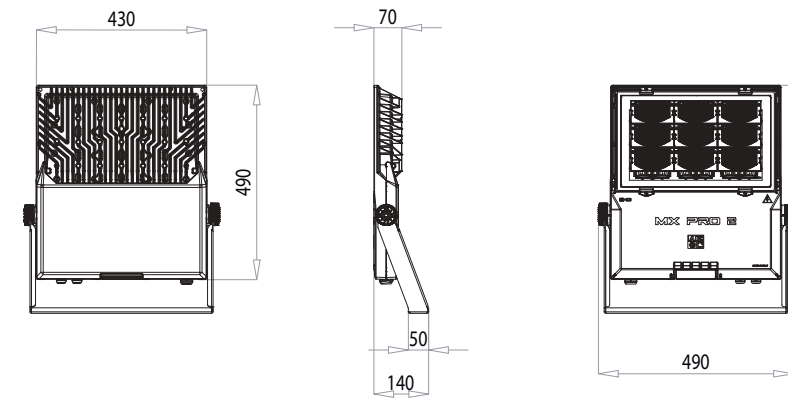

# I-TRON MICRO

*A new concept of street lighting*

**Un concept rivoluzionario.**

**Nuovo design.**

**Nuova ottica.**

**Una nuova dimensione.**

*A revolutionary concept.*

*New design.*

*New optic.*

*A new dimension.*





### I-TRON MICRO

Da 1 a 2 moduli LED  
From 1 to 2 LED modules

# NEWS 2024



### I-TRON ZERO

Da 1 a 4 moduli LED  
From 1 to 4 LED modules



### I-TRON 1

Da 5 a 6 moduli LED  
From 5 to 6 LED modules



### I-TRON 2

Da 7 a 12 moduli LED  
From 7 to 12 LED modules



#### Dimensioni Dimensions

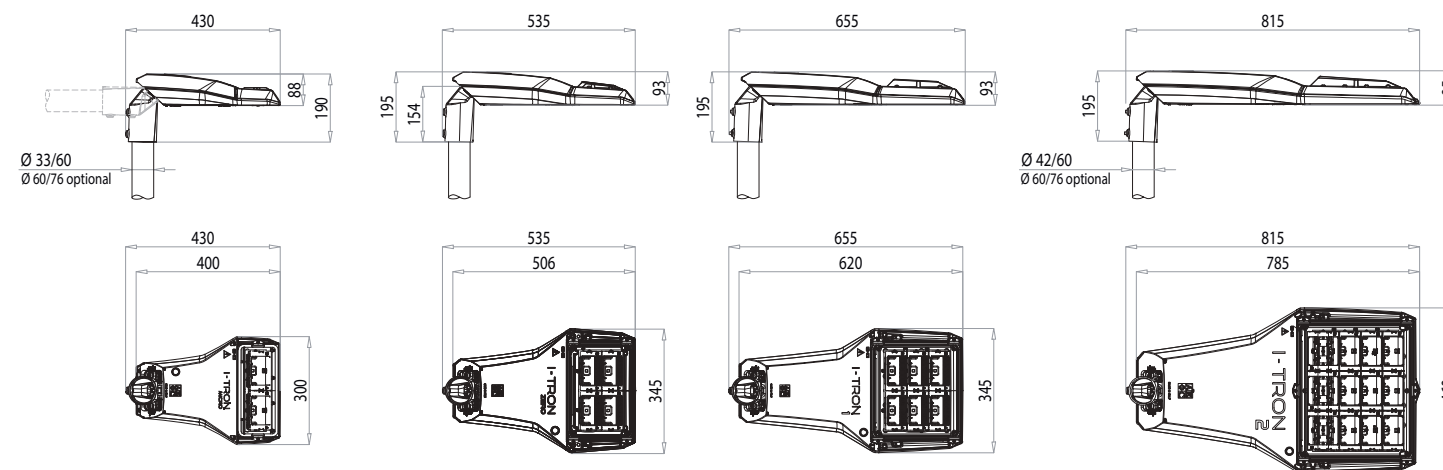

# I-TRON



ILLUMINAZIONE

**Alimentatore**  
Power supply

0% riciclato recycled  
85%\* riciclabile recyclable

**Telaio**  
Alluminio pressofuso

**Frame**  
Die cast aluminium

91% riciclato recycled  
100% riciclabile recyclable

**PCB**

0,33% riciclato recycled  
85%\* riciclabile recyclable

**Riflettore ottico**  
Alluminio

**Optical reflector**  
Aluminium

10% riciclato recycled  
100% riciclabile recyclable

**Schermo ottico**  
Vetro temperato

**Optical screen**  
Tempered glass

31,6% riciclato recycled  
100% riciclabile recyclable

**Copertura**  
Alluminio pressofuso

**Coverage**  
Die cast aluminium

91% riciclato recycled  
100% riciclabile recyclable

**Scaricatore SPD**  
Discharger

0% riciclato recycled  
85%\* riciclabile recyclable

**Gancio di chiusura**  
Alluminio estruso

**Closing hook**  
Extruded aluminium

79% riciclato recycled  
100% riciclabile recyclable

**Testa palo**  
Alluminio pressofuso

**Post-top**  
Die cast aluminium

91% riciclato recycled  
100% riciclabile recyclable

**Piastrine ferma vetro**  
Acciaio zincato

**Glass clamps**  
Galvanized steel

80% riciclato recycled  
100% riciclabile recyclable

Pensato per  
l'ambiente

Designed  
for the environment

**I-TRON è stato progettato per ridurre la nostra impronta ambientale. I materiali impiegati nella costruzione di I-TRON sono riciclabili.**

*I-TRON has been designed to reduce our environmental footprint. The materials used in the construction of I-TRON are recyclable.*



\*Sulla base del rapporto sociale Ecolight 2021  
Based on the Ecolight 2021 social report



**Apertura senza utensili**  
*Tools-free opening*



**Sistema di apertura**  
*Opening system*  
I-TRON ZERO | I-TRON 1 | I-TRON 2



**Sistema di apertura**  
*Opening system*  
I-TRON MICRO





# ITALO

***Street lighting icon***

Designer: Massimo Sacconi

**Design rinnovato.  
Tecnologia evoluta.  
L'illuminazione stradale  
ai massimi livelli.**

*Renewed design.  
Advanced technology.  
Street lighting at the highest level.*







**Dimensioni**  
*Dimensions*

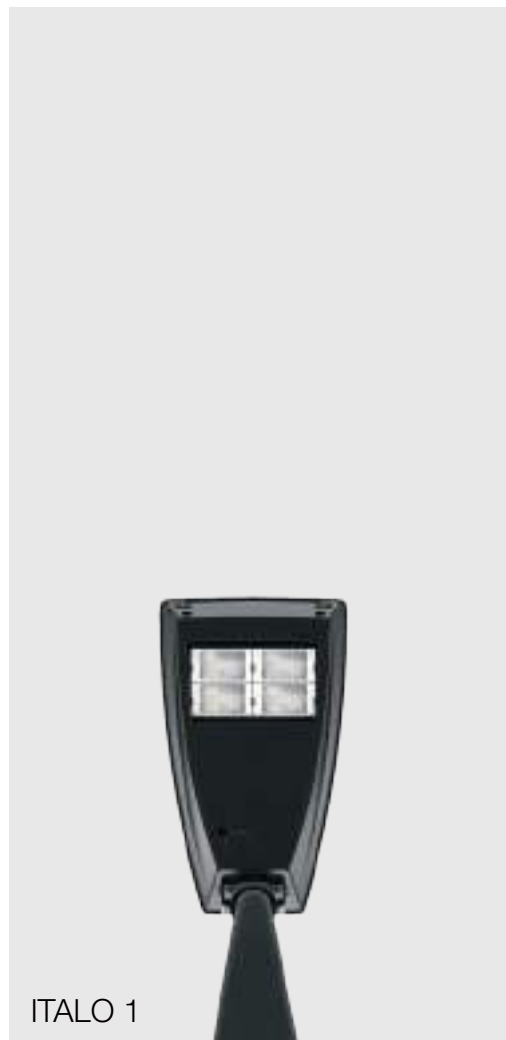
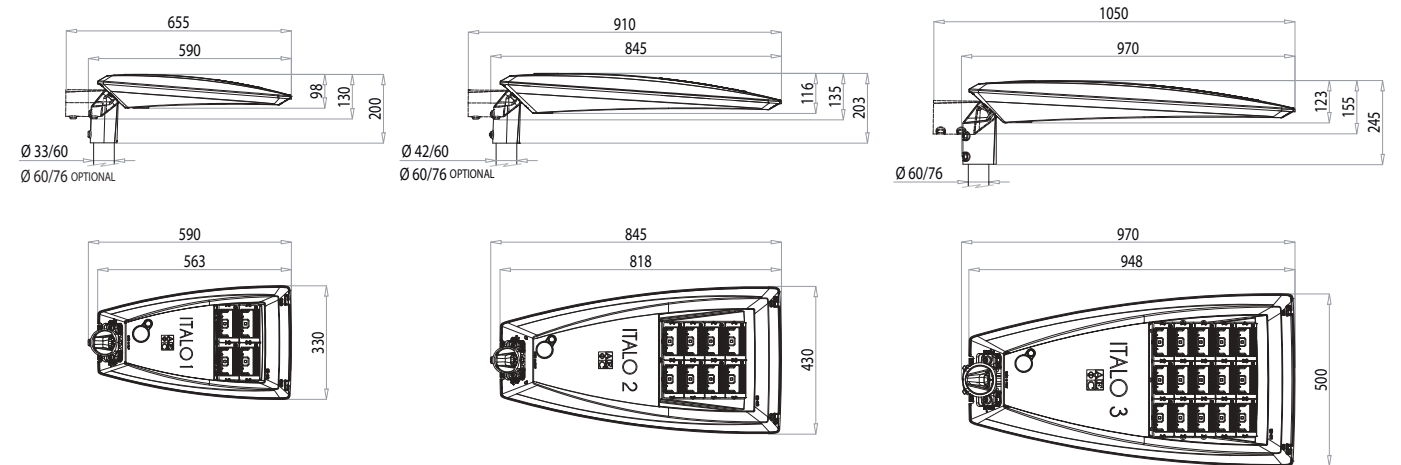

ITALO 1



ITALO 2



ITALO 3

ITALO

**La serie completa**  
*The complete series*



ILLUMINAZIONE



\*Sulla base del rapporto sociale Ecolight 2021  
Based on the Ecolight 2021 social report

Apertura massima  
Maximum opening | 60°





# illuminazione stradale

Street lighting luminaires

Gamma completa  
Complete Gamma

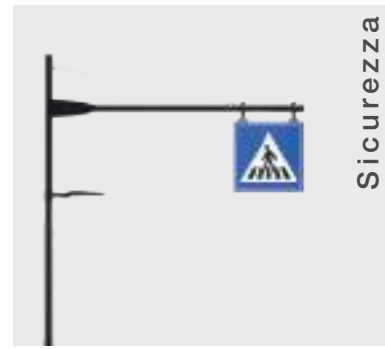
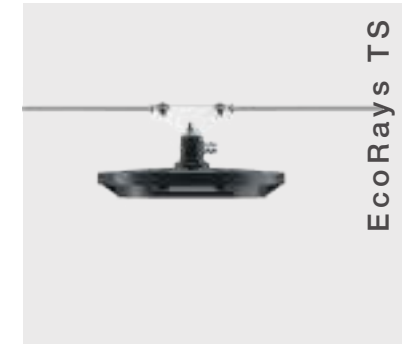

# Street Lighting



# Arredo urbano

Urban lighting luminaires

Gamma completa

Complete Gamma

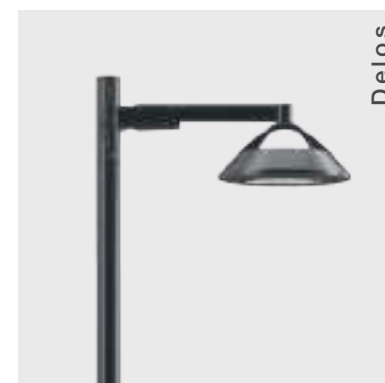
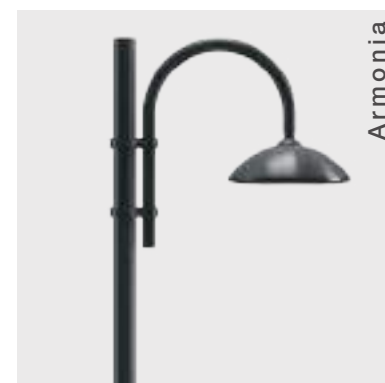
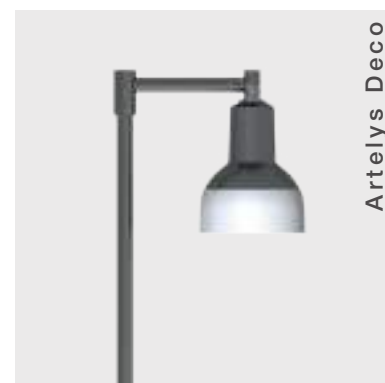
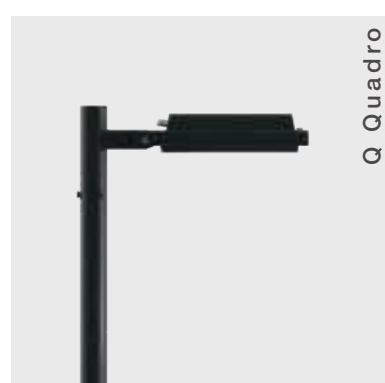
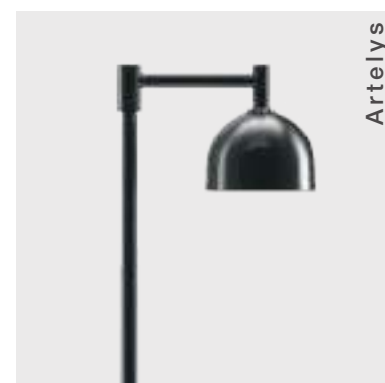
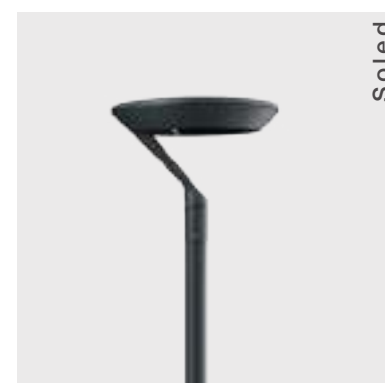
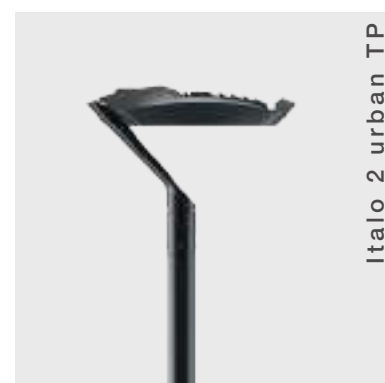
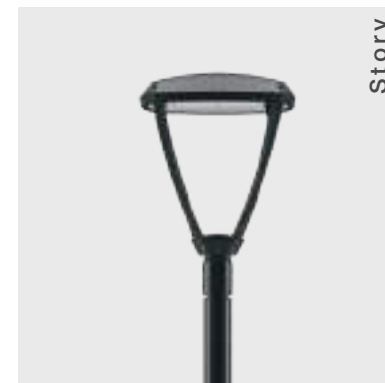
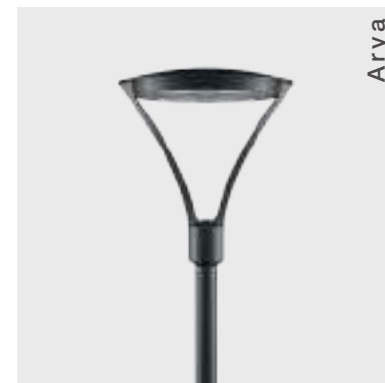
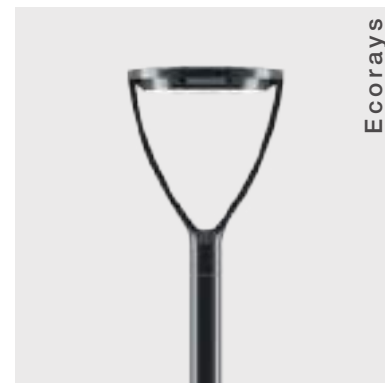
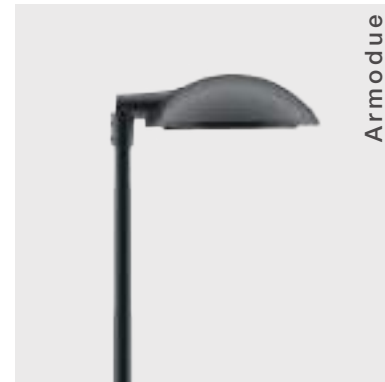



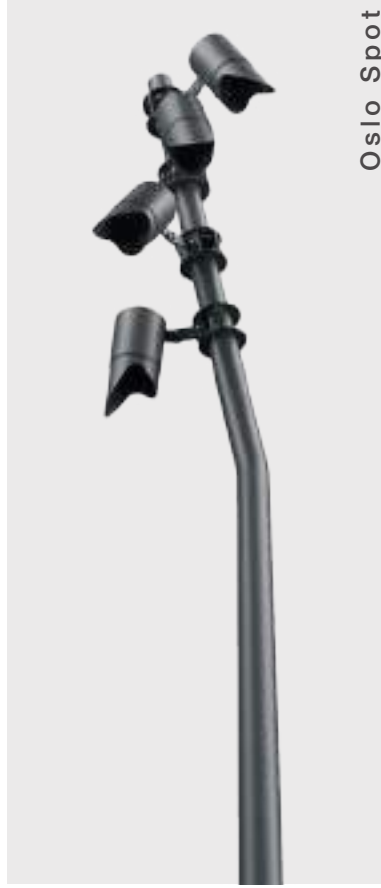
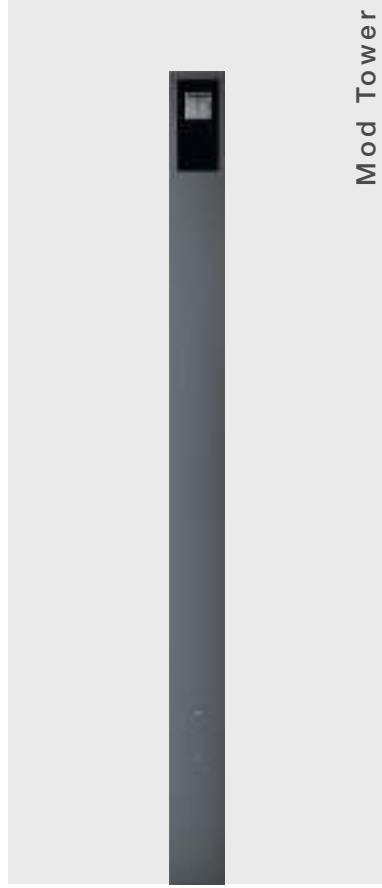

# Urban References





# Proiettori Floodlights

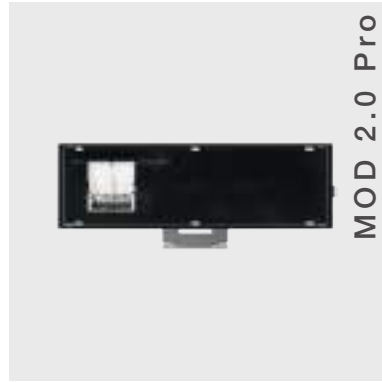

# Floodlighting References

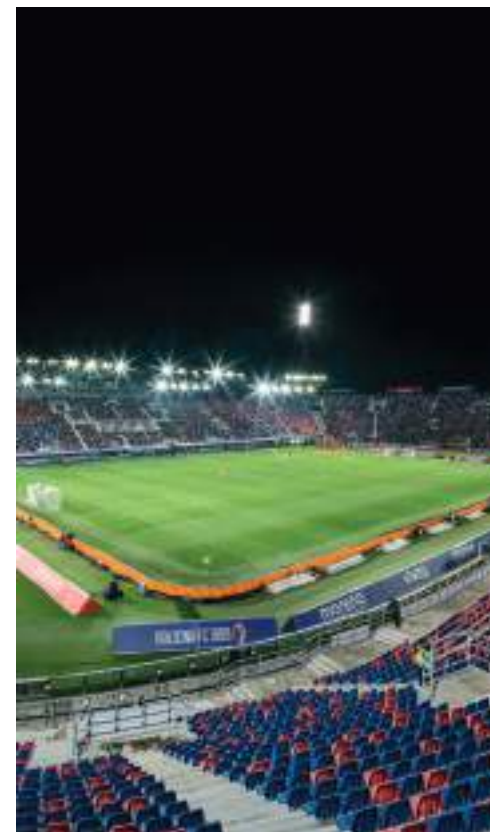



# Serie ALO

ALO floodlight series



# Sport References

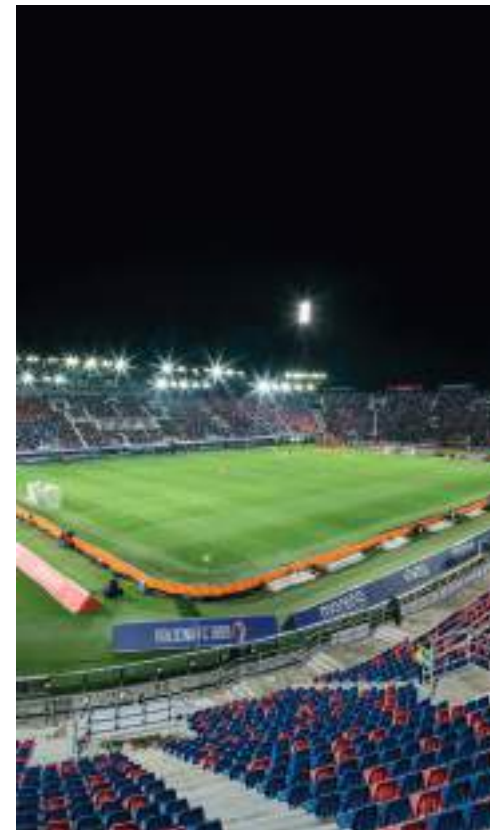

# illuminazione indoor

*Indoor luminaires*



# Indoor Reference







ART DIRECTION  
COPYWRITING  
EDITING  
a cura di

**AEC MARKETING Dept.**

TIPOGRAFIA  
GRAFICHE BADIALI

COPYRIGHT  
**AEC ILLUMINAZIONE**