



Monospot is a floodlight series with innovative technology and design. It comes in 5 sizes with varying wattages. Since the LED modules are located deep inside the reflectors, the luminaires have good cut-off and excellent glare control. In addition to a wide range of fixed light distributions, there is also the Vario Optic version which allows the light beam to be adjusted to suit the specific lighting task. The housings are free of joins and ridges, in or on which dirt and dust can collect. The puristic design and the compact dimensions allow these products to be integrated discreetly into any architectural surrounding.

For the Monospot series there is a gobo projector available with precise optics for sharp-edged image projections. The optical system can accommodate gobos and colour filters simultaneously. With the help of a framer, the edges of the image can be defined and adapted to the size of the projection surface. The Monospot series thus offers many possibilities for imaginative illumination.



Monospot pole luminaires are equipped with a tilt-and-turn fixing system. A wide range of reflectors makes it possible to create different lighting scenarios. The street optic produces a bat-wing type distribution for illuminating paths and driveways.



Clemenstorget, Lund/Sweden
Lighting design: Jørgen Kjær,
COWI Lighting Design, Lyngby/Denmark

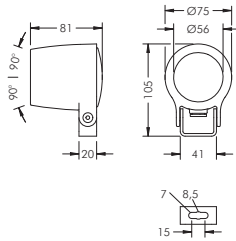

Monospot Mini

With high performance LED,
 CRI: > 80, Colour tolerance: max. 2 SDCM
 Service life: L90/B10 > 50 000 h
 protection class I, IP65 , IK08
 windage area AWW 0.006 m²
 corrosion-resistant die cast aluminium housing AlSi12,
 polyester powder coated,
 precise PMMA optic,
 all exterior steel parts are stainless steel,
 tempered high transmission safety glass,
 silicon gasket,
 mounting bracket powder coated aluminium:
 1 elongated hole Ø 7 mm, spacing 15 mm,
 1 centre hole Ø 8.5 mm, tilt range 180°,
 M16 cable gland,
 integral driver (AC/DC)

Monospot Mini, narrow beam

Part number	Colour	Weight	Light source	Luminous flux	Beam angle γ (FWHM)
8 900 046 019	black	0.5 kg	1 x LED 3 W warm white (3000 K)	128 lm	4°
8 900 066 019	white				
8 900 056 019	silver grey				

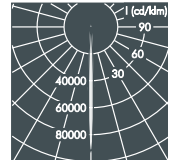
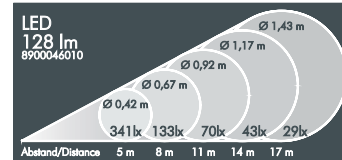

Part number	Colour	Weight	Light source	Luminous flux	Beam angle γ (FWHM)
8 900 045 019	black	0.5 kg	1 x LED 3 W neutral white (4000 K)	136 lm	4°
8 900 065 019	white				
8 900 055 019	silver grey				

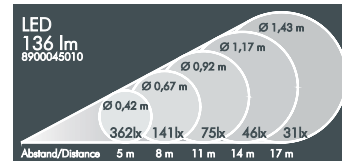

Monospot Mini, linear beam spread, vertical

Part number	Colour	Weight	Light source	Luminous flux	Beam angle γ (FWHM)	
					C 0 – 180	C 90 – 270
8 900 046 029	black	0.5 kg	1 x LED 3 W warm white (3000 K)	130 lm	24°	6°
8 900 066 029	white					
8 900 056 029	silver grey					

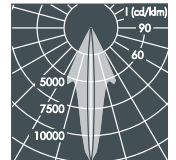
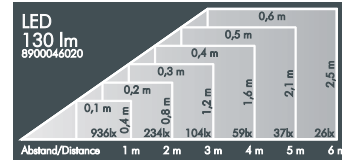

Part number	Colour	Weight	Light source	Luminous flux	Beam angle γ (FWHM)	
					C 0 – 180	C 90 – 270
8 900 045 029	black	0.5 kg	1 x LED 3 W neutral white (4000 K)	140 lm	24°	6°
8 900 065 029	white					
8 900 055 029	silver grey					

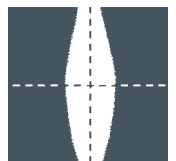
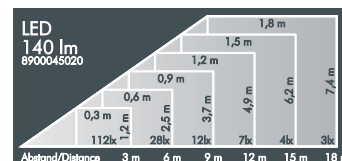

Part number	Description
.3.	Luminaire with linear beam spread, horizontal



Monospot Mini, medium wide beam

Part number	Colour	Weight	Light source	Luminous flux	Beam angle γ (FWHM)
8 900 046 049	black	0.5 kg	1 x LED 3 W warm white (3000 K)	130 lm	13°
8 900 066 049	white				
8 900 056 049	silver grey				

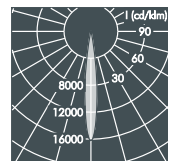
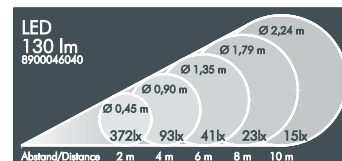

Part number	Colour	Weight	Light source	Luminous flux	Beam angle γ (FWHM)
8 900 045 049	black	0.5 kg	1 x LED 3 W neutral white (4000 K)	142 lm	13°
8 900 065 049	white				
8 900 055 049	silver grey				

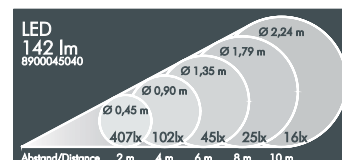

LED (see page 247)

luminaires available in 2700 K and other colour temperatures upon request





Accessories for Monospot Mini

Part number	Colour	Description
129 0 699 940	black	Cowl , stainless steel,
129 0 699 960	white	to avoid lateral glare, for retro-fitting
129 0 699 950	silver grey	

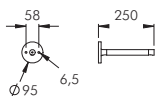

Part number	Colour	Description
129 0 500 940	black	Wall arm 250 mm ,
129 0 500 960	white	aluminium, polyester powder coated
129 0 500 950	silver grey	

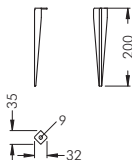

Part number	Colour	Description
129 0 731 940	black	Stainless steel earth spike ,
129 0 731 960	white	for use in landscape lighting
129 0 731 950	silver grey	

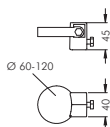

Part number	Colour	Description
128 0 760 940	black	Pole clamp , aluminium,
128 0 760 960	white	polyester powder coated, stainless steel strap,
128 0 760 950	silver grey	for mounting on poles Ø 60 - 120 mm

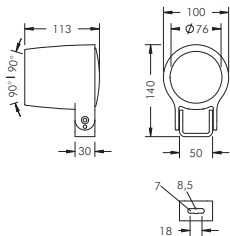

Monospot 1 with mounting bracket

With high performance LED module, integral temperature monitoring device, CRI: > 80, Colour tolerance: max. 3 SDCM
 Service life: L80/B20 > 50 000 h
 protection class I, IP67 , IK08
 windage area AW 0.012 m²
 corrosion-resistant die cast aluminium housing AlSi12, polyester powder coated,
 highly efficient aluminium reflector,
 all exterior steel parts are stainless steel,
 tempered safety glass, silicon gasket,
 closure with 2 stainless steel screws,
 mounting bracket: 1 elongated hole Ø 7 mm,
 spacing 18 mm, 1 centre hole Ø 8,5 mm,
 tilt range 180°, M16 cable gland,
 integral driver (AC/DC)

Monospot 1, narrow beam

Part number	Colour	Weight	Light source	Luminous flux	Beam angle γ (FWHM)
8 901 046 019	black	1.0 kg	1 x LED module 6 W warm white (3000 K)	431 lm	6°
8 901 066 019	white				
8 901 056 019	silver grey				

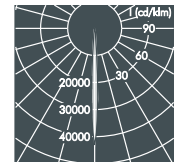
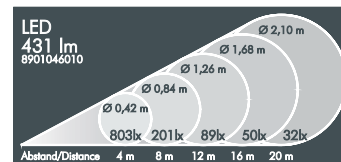

Part number	Colour	Weight	Light source	Luminous flux	Beam angle γ (FWHM)
8 901 045 019	black	1.0 kg	1 x LED module 6 W neutral white (4000 K)	453 lm	6°
8 901 065 019	white				
8 901 055 019	silver grey				

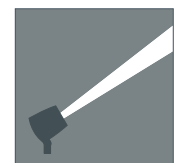
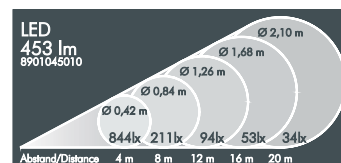

Monospot 1, linear beam spread, vertical

Part number	Colour	Weight	Light source	Luminous flux	Beam angle γ (FWHM)
8 901 046 029	black	1.0 kg	1 x LED module 6 W warm white (3000 K)	392 lm	C 0 – 180
8 901 066 029	white				34°
8 901 056 029	silver grey				7°

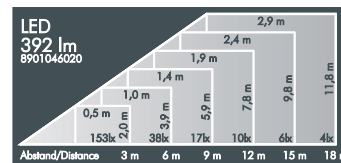

... .3. Luminaire with linear beam spread, horizontal

Monospot 1, linear beam spread, rotatable

Part number	Colour	Description	Luminous flux	Beam angle γ (FWHM)
8 901 046 079	black	Luminaire with external ribbed glass spreader lens, continuously adjustable through 360° from outside the luminaire	353 lm	C 0 – 180
8 901 066 079	white			34°
8 901 056 079	silver grey			7°

Weight 1.1 kg

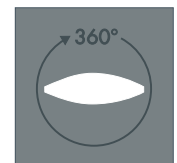

Monospot 1, medium wide beam

Part number	Colour	Weight	Light source	Luminous flux	Beam angle γ (FWHM)
8 901 046 049	black	1.0 kg	1 x LED module 6 W (Zhaga) warm white (3000 K)	449 lm	34°
8 901 066 049	white				
8 901 056 049	silver grey				

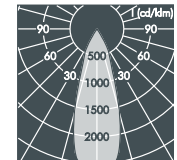
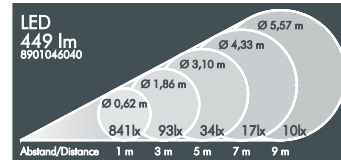

Monospot 1, wide beam

Part number	Colour	Weight	Light source	Luminous flux	Beam angle γ (FWHM)
8 901 046 059	black	1.0 kg	1 x LED module 6 W (Zhaga) warm white (3000 K)	549 lm	44°
8 901 066 059	white				
8 901 056 059	silver grey				

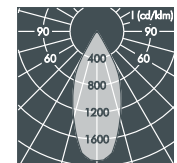
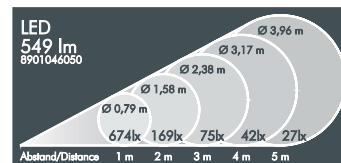

Part number	Colour	Weight	Light source	Luminous flux	Beam angle γ (FWHM)
8 901 045 059	black	1.0 kg	1 x LED module 6 W (Zhaga) neutral white (4000 K)	576 lm	44°
8 901 065 059	white				
8 901 055 059	silver grey				

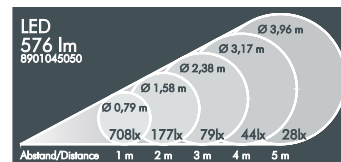

Part number	Description
... .5 ...	Luminaire with neutral white colour temperature (4000 K)

LED (see page 247)
 Luminaires available in 2700 K or other colour temperatures upon request



Monospot 2 with mounting bracket

With high performance LED module (Zhaga), integral temperature monitoring device, CRI: > 80, Colour tolerance: max. 3 SDCM
 Service life: L80/B20 > 50 000 h
 protection class I or II, IP67 , IK08 windage area AW 0.021 m²
 corrosion-resistant die cast aluminium housing AlSi12, polyester powder coated, highly efficient aluminium reflector, all exterior steel parts are stainless steel, tempered safety glass, silicon gasket, closure with 2 stainless steel screws, mounting bracket: 2 drilled holes Ø 7 mm, spacing 30-40 mm, 1 centre hole Ø 17 mm, tilt range 180°, M16 cable gland, integral driver (AC/DC)

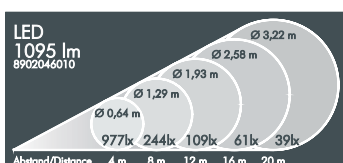
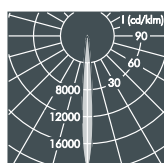
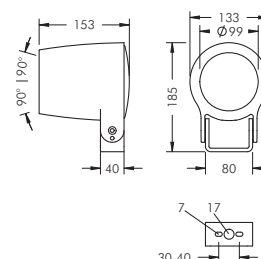

Monospot 2, narrow beam

Part number	Colour	Weight	Light source	Luminous flux	Beam angle γ (FWHM)
8 902 046 019	black	1.9 kg	1 x LED module 15 W warm white (3000 K)	1095 lm	8°
8 902 066 019	white				
8 902 056 019	silver grey				

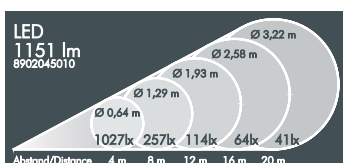

Part number	Colour	Weight	Light source	Luminous flux	Beam angle γ (FWHM)
8 902 045 019	black	1.9 kg	1 x LED module 15 W neutral white (4000 K)	1151 lm	8°
8 902 065 019	white				
8 902 055 019	silver grey				

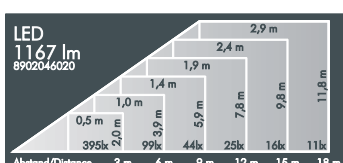

Monospot 2, linear beam spread, vertical

Part number	Colour	Weight	Light source	Luminous flux	Beam angle γ (FWHM)
8 902 046 029	black	1.9 kg	1 x LED module 15 W warm white (3000 K)	1167 lm	C 0 – 180 C 90 – 270
8 902 066 029	white				35° 8°
8 902 056 029	silver grey				

. 3. Luminaire with linear beam spread, horizontal

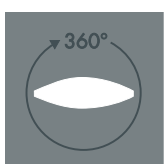

Monospot 2, linear beam spread, rotatable

Part number	Colour	Description	Luminous flux	Beam angle γ (FWHM)
8 902 046 079	black	Luminaire with external ribbed glass spreader lens, continuously adjustable through 360° from outside the luminaire	1008 lm	C 0 – 180
8 902 066 079	white			C 90 – 270
8 902 056 079	silver grey			35° 8°
		Weight 2.0 kg		

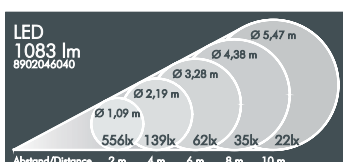
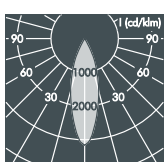

Monospot 2, medium wide beam

Part number	Colour	Weight	Light source	Luminous flux	Beam angle γ (FWHM)
8 902 046 049	black	1.9 kg	1 x LED module 15 W warm white (3000 K)	1083 lm	31°
8 902 066 049	white				
8 902 056 049	silver grey				

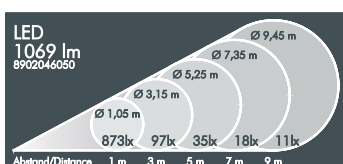
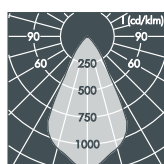

Monospot 2, wide beam

Part number	Colour	Weight	Light source	Luminous flux	Beam angle γ (FWHM)
8 902 046 059	black	1.9 kg	1 x LED module 15 W warm white (3000 K)	1069 lm	55°
8 902 066 059	white				
8 902 056 059	silver grey				

Part number	Description
. . . 6	Protection class II luminaire
. 5	Luminaire with neutral white colour temperature (4000 K)
. 1	Dimmable luminaire (DALI)
. 2	Dimmable luminaire (1-10 V)

LED (see page 247)

Luminaires available in 2700 K or other colour temperatures upon request



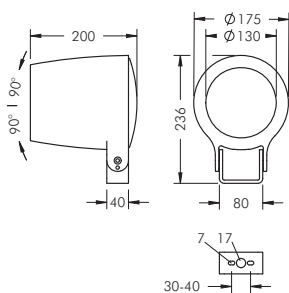

Monospot 3 with mounting bracket

With high performance LED module (Zhaga), integral temperature monitoring device, CRI: > 85, Colour tolerance: 2 SDCM
 Service life: L90/B10 > 50 000 h
 protection class I or II, IP67 IK08
 windage area AW 0.034 m²
 corrosion-resistant die cast aluminium housing AlSi12, polyester powder coated, highly efficient aluminium reflector or lens made of optical silicon (Street Optic), all exterior steel parts are stainless steel, tempered safety glass, silicon gasket, closure with 3 stainless steel screws, mounting bracket: 2 drilled holes \varnothing 7 mm, spacing 30-40 mm, 1 centre hole \varnothing 17 mm, tilt range 180°, M20 cable gland, integral driver (AC/DC)

Monospot 3, narrow beam

Part number	Colour	Weight	Light source	Luminous flux	Beam angle γ (FWHM)
8 903 046 019	black	3.1 kg	1 x LED module 36 W warm white (3000 K)	3289 lm	9°
8 903 066 019	white				
8 903 056 019	silver grey				

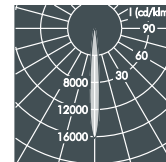
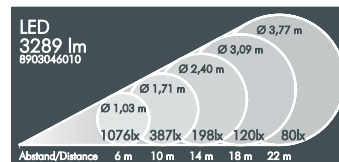

Monospot 3, linear beam spread, vertical

Part number	Colour	Weight	Light source	Luminous flux	Beam angle γ (FWHM)
8 903 046 029	black	3.1 kg	1 x LED module 36 W warm white (3000 K)	2829 lm	C 0 – 180
8 903 066 029	white				36°
8 903 056 029	silver grey				9°

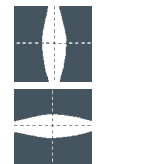
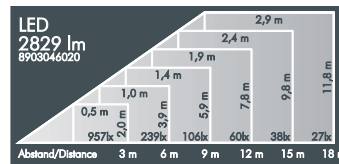

. 3. Luminaire with linear beam spread, horizontal

Monospot 3, linear beam spread, rotatable

Part number	Colour	Description	Luminous flux	Beam angle γ (FWHM)
8 903 046 079	black	Luminaire with external ribbed glass spreader lens, continuously adjustable through 360° from outside the luminaire	2603 lm	C 0 – 180
8 903 066 079	white			36°
8 903 056 079	silver grey			9°

Weight 3.2 kg

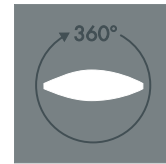

Monospot 3, medium wide beam

Part number	Colour	Weight	Light source	Luminous flux	Beam angle γ (FWHM)
8 903 046 049	black	3.1 kg	1 x LED module 36 W warm white (3000 K)	3283 lm	30°
8 903 066 049	white				
8 903 056 049	silver grey				

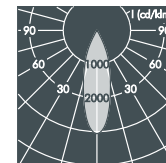
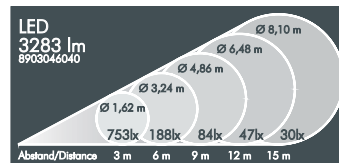

Monospot 3, wide beam

Part number	Colour	Weight	Light source	Luminous flux	Beam angle γ (FWHM)
8 903 046 059	black	3.1 kg	1 x LED module 36 W warm white (3000 K)	3348 lm	53°
8 903 066 059	white				
8 903 056 059	silver grey				

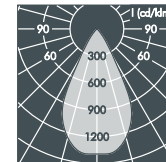
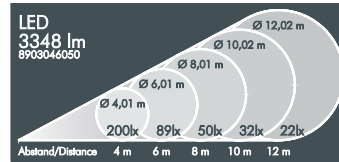

Monospot 3, Street Optic

Part number	Colour	Weight	Light source	Luminous flux	Beam angle γ (FWHM)
8 903 046 089	black	3.9 kg	1 x LED module 36 W warm white (3000 K)	3236 lm	C 0 – 180
8 903 066 089	white				51°
8 903 056 089	silver grey				121°

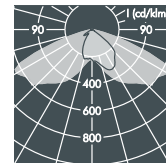
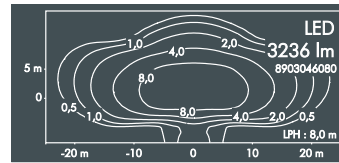

Part number	Description
. . . 7	Protection class II luminaire
. 5	Luminaire with neutral white colour temperature (4000 K)
. 1	Dimmable luminaire (DALI)
. 2	Dimmable luminaire (1-10 V) *

* Not available for Monospot 3, Street Optic

LED (see page 247)

Luminaires available in 2700 K or other colour temperatures upon request



Monospot 3 Vario Optic with mounting bracket

With high performance LED module (Zhaga), integral temperature monitoring device, CRI: > 85, Colour tolerance: 2 SDCM
 Service life: L90/B10 > 50 000 h
 protection class I or II, IP67 , IK08 windage area AW 0.034 m²
 corrosion-resistant die cast aluminium housing AlSi12, polyester powder coated, high transmission glass optical lens, beam angle adjustable from outside the luminaire, all exterior steel parts are stainless steel, tempered safety glass, silicon gasket, closure with 3 stainless steel screws, mounting bracket: 2 drilled holes Ø 7 mm, spacing 30-40 mm, 1 centre hole Ø 17 mm, tilt range 180°, M20 cable gland, integral driver (AC/DC)

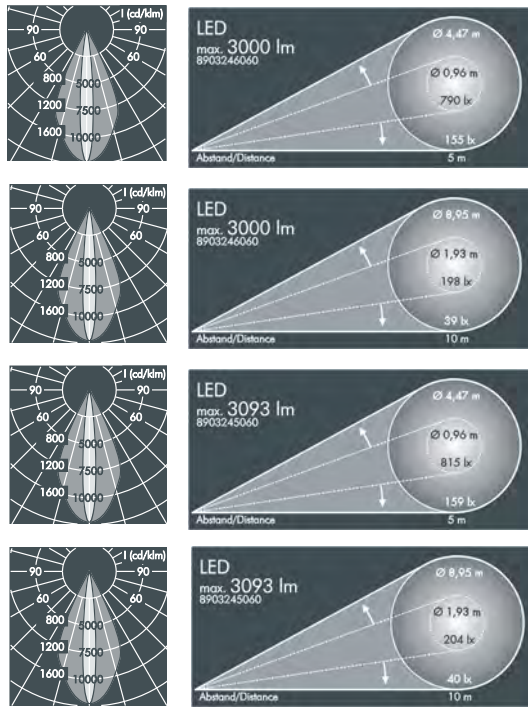
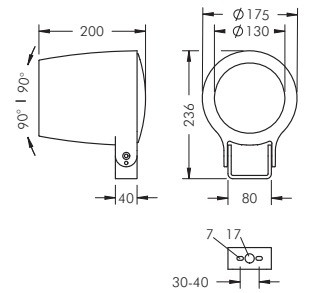

Monospot 3 Vario Optic

Part number	Colour	Weight	Light source	Luminous flux	Beam angle γ (FWHM)
8 903 046 069	black	3.8 kg	1 x LED module 36 W warm white (3000 K)	max. 3000 lm	11°-48°
8 903 066 069	white				
8 903 056 069	silver grey				

Part number	Colour	Weight	Light source	Luminous flux	Beam angle γ (FWHM)
8 903 045 069	black	3.8 kg	1 x LED module 36 W neutral white (4000 K)	max. 3093 lm	11°-48°
8 903 065 069	white				
8 903 055 069	silver grey				

Part number	Description
... 7 ...	Protection class II luminaire
... 1 ..	Dimmable luminaire (DALI)
... 2 ..	Dimmable luminaire (1-10 V)

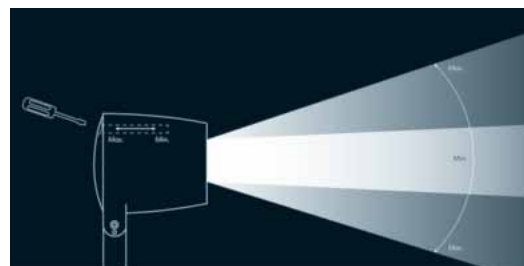

The Vario Optic makes it possible to adjust the beam angle. This is done from outside the luminaire so that the optimal beam angle can be achieved while the floodlight is switched on. This function offers a high degree of flexibility, for example in landscape lighting.

LED (see page 247)

Luminaires available in 2700 K or other colour temperatures upon request



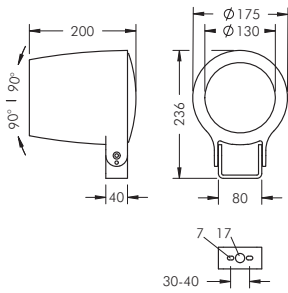

Monospot 3 with mounting bracket asymmetrical beam

With high performance LED module (Zhaga), integral temperature monitoring device, CRI: > 85, Colour tolerance: 2 SDCM
Service life: L90/B10 > 50 000 h
protection class I or II, IP67 , IK08
windage area AW 0.034 m²
corrosion-resistant die cast aluminium housing AlSi12, polyester powder coated,
highly efficient reflector,
all exterior steel parts are stainless steel, tempered safety glass, silicon gasket, closure with 3 stainless steel screws,
mounting bracket: 2 drilled holes Ø 7 mm, spacing 30-40 mm, 1 centre hole Ø 17 mm, tilt range 180°, M20 cable gland, integral driver (AC/DC)

Monospot 3, asymmetrical beam

Part number	Colour	Weight	Light source	Luminous flux	Main beam angle γ
8 903 046 099	black	3.5 kg	1 x LED module 36 W warm white (3000 K)	2938 lm	18°
8 903 066 099	white				
8 903 056 099	silver grey				

Part number	Colour	Weight	Light source	Luminous flux	Main beam angle γ
8 903 045 099	black	3.5 kg	1 x LED module 36 W neutral white (4000 K)	3085 lm	18°
8 903 065 099	white				
8 903 055 099	silver grey				

Part number	Description
. . . 7	Protection class II luminaire
. 1 . .	Dimmable luminaire (DALI)
. 2 . .	Dimmable luminaire (1-10 V)

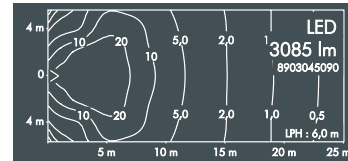
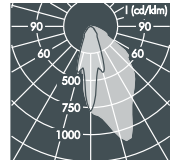
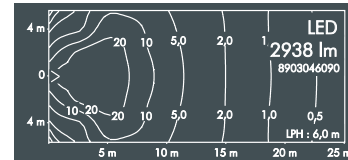

LED (see page 247)

Luminaires available in 2700 K or other colour temperatures upon request



Monospot 4 with mounting bracket

With high performance LED module (Zhaga), integral temperature monitoring device, CRI: > 85, Colour tolerance: 2 SDCM
 Service life: L90/B10 > 50 000 h
 protection class I or II, IP67 , IK08
 windage area AW 0.051 m²
 corrosion-resistant die cast aluminium housing AlSi12, polyester powder coated,
 highly efficient aluminium reflector or lens made of optical silicon (Street Optic),
 all exterior steel parts are stainless steel, tempered safety glass,
 silicon gasket, closure with 3 stainless steel screws,
 mounting bracket: 2 drilled holes Ø 7 mm, spacing 40-60 mm, 1 centre hole Ø 21 mm,
 tilt range 180°, M20 cable gland,
 integral driver (AC/DC)

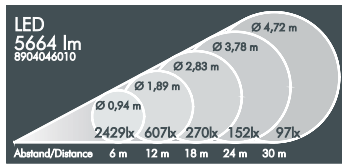
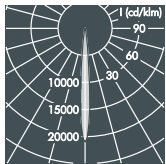
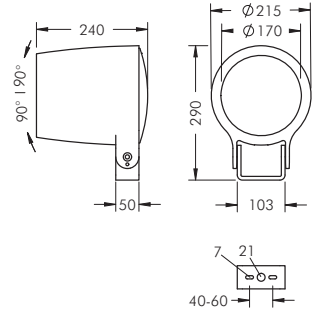

Monospot 4, narrow beam

Part number	Colour	Weight	Light source	Luminous flux	Beam angle γ (FWHM)
8 904 046 019	black	4.9 kg	1 x LED module 70 W warm white (3000 K)	5664 lm	9°
8 904 066 019	white				
8 904 056 019	silver grey				

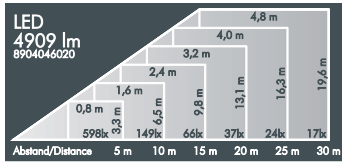

Monospot 4, linear beam spread, vertical

Part number	Colour	Weight	Light source	Luminous flux	Beam angle γ (FWHM)
8 904 046 029	black	4.9 kg	1 x LED module 70 W warm white (3000 K)	4909 lm	C 0 – 180
8 904 066 029	white				C 90 – 270
8 904 056 029	silver grey				36°

... 3. Luminaire with linear beam spread, horizontal

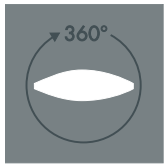

Monospot 4, linear beam spread, rotatable

Part number	Colour	Description	Luminous flux	Beam angle γ (FWHM)
8 904 046 079	black	Luminaire with external ribbed glass spreader lens, continuously adjustable through 360° from outside the luminaire	4517 lm	C 0 – 180
8 904 066 079	white			C 90 – 270
8 904 056 079	silver grey			36°

Weight 5.1 kg

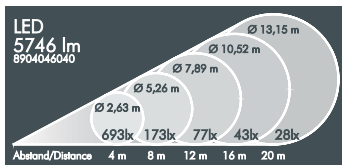
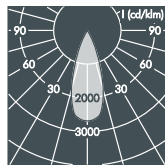

Monospot 4, medium wide beam

Part number	Colour	Weight	Light source	Luminous flux	Beam angle γ (FWHM)
8 904 046 049	black	4.9 kg	1 x LED module 70 W warm white (3000 K)	5746 lm	36°
8 904 066 049	white				
8 904 056 049	silver grey				

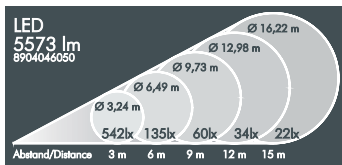
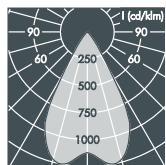

Monospot 4, wide beam

Part number	Colour	Weight	Light source	Luminous flux	Beam angle γ (FWHM)
8 904 046 059	black	4.9 kg	1 x LED module 70 W warm white (3000 K)	5573 lm	57°
8 904 066 059	white				
8 904 056 059	silver grey				

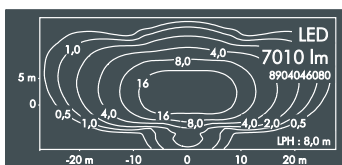
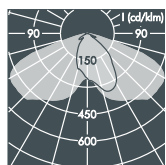

Monospot 4, Street Optic

Part number	Colour	Weight	Light source	Luminous flux	Beam angle γ (FWHM)
8 904 046 089	black	5.1 kg	1 x LED module 70 W warm white (3000 K)	7010 lm	C 0 – 180
8 904 066 089	white				C 90 – 270
8 904 056 089	silver grey				51°

Part number	Description
. . . 8	Protection class II luminaire
. 5 . . .	Luminaire with neutral white colour temperature (4000 K)
. 1 . .	Dimmable luminaire (DALI)
Part number *	Description
. . . 4 . . 9 0 . .	Luminaire with LED module RGBW max. 49 W
. . . 4 . . 2 1 . .	Luminaire with Tuneable White LED max. 37 W (2700 K - 6500 K)

* Not available for Monospot 4, Street Optic

LED (see page 247)

Luminaires available in 2700 K or other colour temperatures upon request



Monospot Gobo

With high performance LED module, CRI: > 70, colour tolerance: max. 4 SDCM
 Service life: L70/B20 > 50 000 h
 protection class I, IP65 , IK08
 windage area AW 0.074 m², corrosion-resistant die cast aluminium housing AlSi12, polyester powder coated, focusable lens, carrier for gobos and colour filters, all exterior steel parts are stainless steel, tempered safety glass, silicon gasket, closure with 3 stainless steel screws, mounting bracket: 2 drilled holes Ø 7 mm, spacing 40-60 mm, 1 centre hole Ø 21 mm, tilt range 180°, M20 cable gland, integral driver (AC/DC)

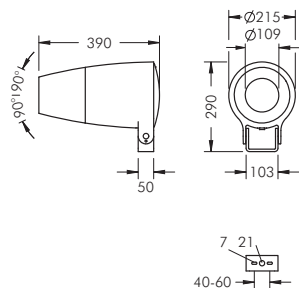

Monospot Gobo, 63 mm focal length

Part number	Colour	Weight	Light source	Luminous flux	Beam angle
8 905 044 059	black	6.7 kg	1 x LED module 47 W cool white (6500 K)	1000 lm	30°
8 905 064 059	white				
8 905 054 059	silver grey				

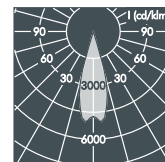
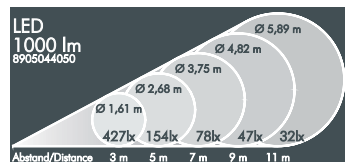

Monospot Gobo, 85 mm focal length

Part number	Colour	Weight	Light source	Luminous flux	Beam angle
8 905 044 049	black	6.7 kg	1x LED module 47 W cool white (6500 K)	1095 lm	20°
8 905 064 049	white				
8 905 054 049	silver grey				

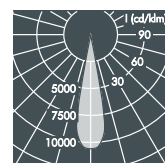
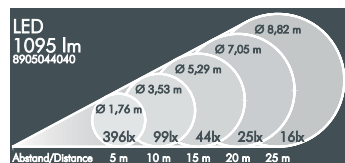

Monospot Gobo, 150 mm focal length

Part number	Colour	Weight	Light source	Luminous flux	Beam angle
8 905 044 019	black	6.7 kg	1x LED module 47 W cool white (6500 K)	907 lm	12°
8 905 064 019	white				
8 905 054 019	silver grey				

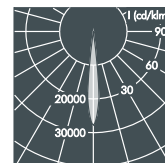
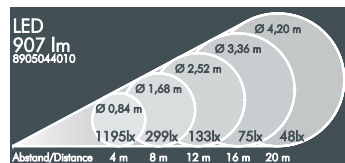

Part number	Description
. 1..	Dimmable version (DALI)
. 2..	Dimmable version (1-10 V)

Accessories Monospot Gobo

Part number	Colour	Description
129 0 551 000	yellow	Dichroic colour filter
129 0 557 000	red	
129 0 553 000	blue	
129 0 558 000	green	

Part number	Description
129 0 780 000	Fraser for sharp edges on 3- or 4-sided images

Part number	Example	Description
129 0 489 000	waves	Standard gobos Ø 50 mm
129 0 490 000	stars	
129 0 491 000	hash	



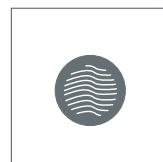

Custom made gobos can be produced from image data in one of the following file formats: **EPS** (min. 300 dpi), **TIF** (min. 300 dpi), **JPG** (in low compression).
 Max. image size D on gobo: D = 38 mm (outer diameter gobo 50 mm)



LED (see page 247)



Monospot 2 pole luminaire

With high performance LED module (Zhaga),
 integral temperature monitoring device,
 CRI: > 80, Colour tolerance: max. 3 SDCM
 Service life: L80/B20 > 50 000 h
 protection class I or II, IP67    , IK08
 windage area AW 0.021 m²
 corrosion-resistant die cast aluminium housing AlSi12,
 polyester powder coated,
 highly efficient aluminium reflector,
 all exterior steel parts are stainless steel,
 tempered safety glass, silicon gasket,
 closure with 2 stainless steel screws,
 for installation on poles Ø 60 - 100 mm,
 tiltable base made of powder coated aluminium,
 2 drilled holes Ø 9 mm, spacing 95 mm,
 1 centre hole Ø 13.5 mm, tilt range 90°,
 swivel range 360°, M16 cable gland,
 integral driver (AC/DC)

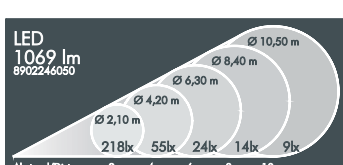
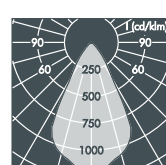
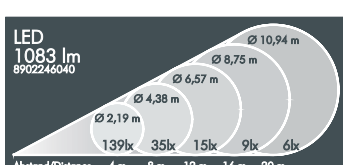
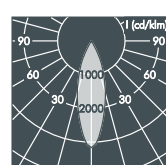
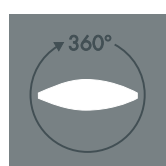
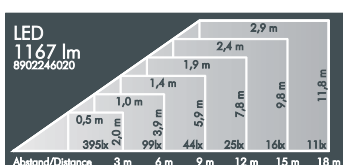
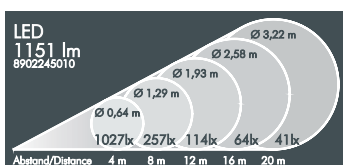
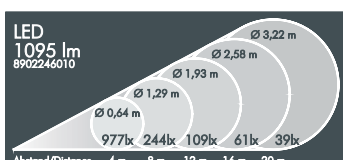
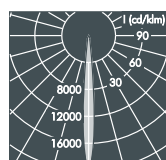
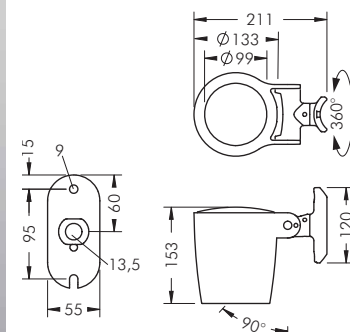

LED (see page 247)

Luminaires available in 2700 K or other colour temperatures upon request



Monospot 2 pole luminaire, narrow beam

Part number	Colour	Weight	Light source	Luminous flux	Beam angle γ (FWHM)
8 902 246 019	black	2.1 kg	1 x LED module 15 W warm white (3000 K)	1095 lm	8°
8 902 266 019	white				
8 902 256 019	silver grey				

Part number	Colour	Weight	Light source	Luminous flux	Beam angle γ (FWHM)
8 902 245 019	black	2.1 kg	1 x LED module 15 W neutral white (4000 K)	1151 lm	8°
8 902 265 019	white				
8 902 255 019	silver grey				

Monospot 2 pole luminaire, linear beam spread, vertical

Part number	Colour	Weight	Light source	Luminous flux	Beam angle γ (FWHM)
8 902 246 029	black	2.1 kg	1 x LED module 15 W warm white (3000 K)	1167 lm	C 0 - 180
8 902 266 029	white				C 90 - 270
8 902 256 029	silver grey				35°

... 3. Luminaire with linear beam spread, horizontal

Monospot 2 pole luminaire, linear beam spread, rotatable

Part number	Colour	Description	Luminous flux	Beam angle γ (FWHM)
8 902 246 079	black	Luminaire with external ribbed glass spreader lense, continuously adjustable through 360° from outside the luminaire	1008 lm	C 0 - 180
8 902 266 079	white			C 90 - 270
8 902 256 079	silver grey			35°
		Weight 2.2 kg		

Monospot 2 pole luminaire, medium wide beam

Part number	Colour	Weight	Light source	Luminous flux	Beam angle γ (FWHM)
8 902 246 049	black	2.1 kg	1 x LED module 15 W warm white (3000 K)	1083 lm	31°
8 902 266 049	white				
8 902 256 049	silver grey				

Monospot 2 pole luminaire, wide beam

Part number	Colour	Weight	Light source	Luminous flux	Beam angle γ (FWHM)
8 902 246 059	black	2.1 kg	1 x LED module 15 W warm white (3000 K)	1069 lm	55°
8 902 266 059	white				
8 902 256 059	silver grey				

Part number	Description
... 6 ...	Protection class II luminaire
... 5 ...	Luminaire with neutral white colour temperature (4000 K)
... 1 ..	Dimmable luminaire (DALI)
... 2 ..	Dimmable luminaire (1-10 V)

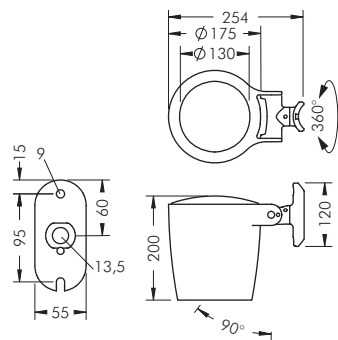

Monospot 3 pole luminaire

With high performance LED module (Zhaga), integral temperature monitoring device, CRI: > 85, Colour tolerance: 2 SDCM
 Service life: L90/B10 > 50 000 h
 protection class I or II, IP67 IK08
 windage area AW 0.034 m²
 corrosion-resistant die cast aluminium housing AlSi12, polyester powder coated,
 highly efficient aluminium reflector,
 all exterior steel parts are stainless steel,
 tempered safety glass, silicon gasket,
 closure with 3 stainless steel screws,
 for installation on poles Ø 60 - 100 mm,
 tiltable base made of powder coated aluminium,
 2 drilled holes Ø 9 mm, spacing 95 mm,
 1 drilled hole Ø 13.5 mm, tilt range 90°,
 swivel range 360°, M20 cable gland,
 integral driver (AC/DC)

Monospot 3 pole luminaire, narrow beam

Part number	Colour	Weight	Light source	Luminous flux	Beam angle γ (FWHM)
8 903 246 019	black	3.3 kg	1 x LED module 36 W warm white (3000 K)	3289 lm	9°
8 903 266 019	white				
8 903 256 019	silver grey				

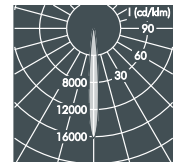
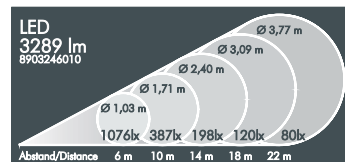

Monospot 3 pole luminaire, linear beam spread, vertical

Part number	Colour	Weight	Light source	Luminous flux	Beam angle γ (FWHM)
8 903 246 029	black	3.3 kg	1 x LED module 36 W warm white (3000 K)	2829 lm	C 0 – 180
8 903 266 029	white				36°
8 903 256 029	silver grey				9°

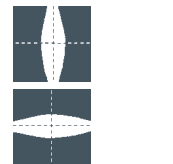
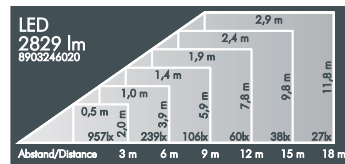

. 3. Luminaire with linear beam spread, horizontal

Monospot 3 pole luminaire, linear beam spread, rotatable

Part number	Colour	Description	Luminous flux	Beam angle γ (FWHM)
8 903 246 079	black	Luminaire with external ribbed glass spreader lens, continuously adjustable through 360° from outside the luminaire	2603 lm	C 0 – 180
8 903 266 079	white			36°
8 903 256 079	silver grey			9°

Weight 3.4 kg

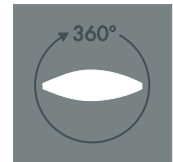

Monospot 3 pole luminaire, medium wide beam

Part number	Colour	Weight	Light source	Luminous flux	Beam angle γ (FWHM)
8 903 246 049	black	3.3 kg	1 x LED module 36 W warm white (3000 K)	3283 lm	30°
8 903 266 049	white				
8 903 256 049	silver grey				

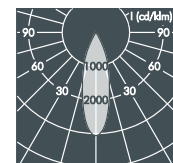
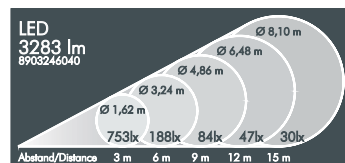

Monospot 3 pole luminaire, wide beam

Part number	Colour	Weight	Light source	Luminous flux	Beam angle γ (FWHM)
8 903 246 059	black	3.3 kg	1 x LED module 36 W warm white (3000 K)	3348 lm	53°
8 903 266 059	white				
8 903 256 059	silver grey				

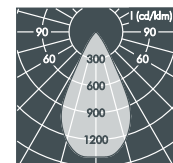
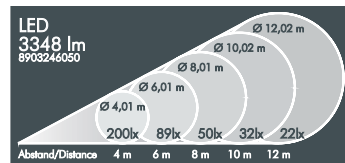

Monospot 3 pole luminaire, asymmetrical beam

Part number	Colour	Weight	Light source	Luminous flux	Main beam angle γ
8 903 246 099	black	3.7 kg	1 x LED module 36 W warm white (3000 K)	2938 lm	18°
8 903 266 099	white				
8 903 256 099	silver grey				

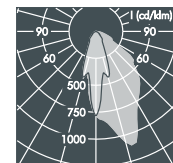
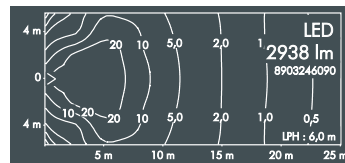

Part number	Description
. . . 7	Protection class II luminaire
. 5	Luminaire with neutral white colour temperature (4000 K)
. 1	Dimmable luminaire (DALI)
. 2	Dimmable luminaire (1-10 V)



LED (see page 247)

Luminaires available in 2700 K or other colour temperatures upon request



Monospot 3 Vario Optic pole luminaire

With high performance LED module (Zhaga), integral temperature monitoring device, CRI: > 85, Colour tolerance: 2 SDCM
 Service life: L80/B20 > 50 000 h
 protection class I or II, IP67 , IK08 windage area AW 0.034 m²
 corrosion-resistant die cast aluminium housing AlSi12, polyester powder coated, high transmission glass optical lens, beam angle adjustable from outside the luminaire, all exterior steel parts are stainless steel, tempered safety glass, silicon gasket, closure with 3 stainless steel screws, for installation on poles Ø 60 - 100 mm, tiltable base made of powder coated aluminium, 2 drilled holes Ø 9 mm, spacing 95 mm, 1 drilled hole Ø 13.5 mm, tilt range 90°, swivel range 360°, M20 cable gland, integral driver (AC/DC)

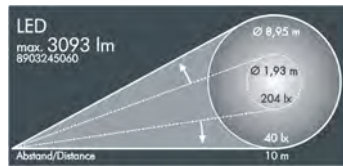
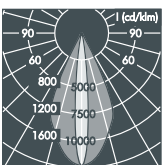
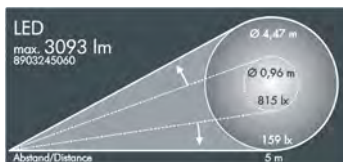
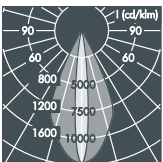
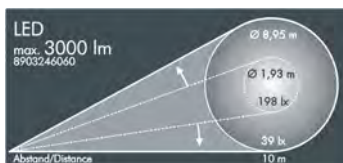
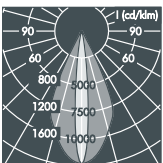
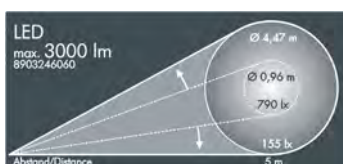
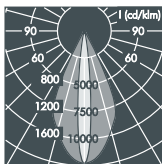
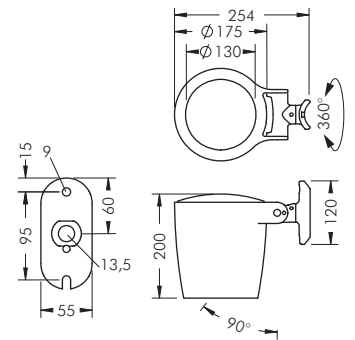

Monospot 3 pole luminaire, Vario Optic

Part number	Colour	Weight	Light source	Luminous flux	Beam angle γ (FWHM)
8 903 246 069	black	4.0 kg	1 x LED module 36 W warm white (3000 K)	max. 3000 lm	11°-48°
8 903 266 069	white				
8 903 256 069	silver grey				

Part number	Colour	Weight	Light source	Luminous flux	Beam angle γ (FWHM)
8 903 245 069	black	4.0 kg	1 x LED module 36 W neutral white (4000 K)	max. 3093 lm	11°-48°
8 903 265 069	white				
8 903 255 069	silver grey				

Part number	Description
. . . 7	Protection class II luminaire
. 1 . .	Dimmable luminaire (DALI)
. 2 . .	Dimmable luminaire (1-10 V)

LED (see page 247)

Luminaires available in 2700 K or other colour temperatures upon request



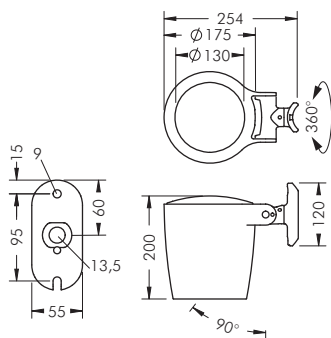

Monospot 3 Street Optic pole luminaire

With high performance LED module (Zhaga), integral temperature monitoring device, CRI: > 85, Colour tolerance: 2 SDCM
 Service life: L90/B10 > 50 000 h
 protection class I or II, IP67 , IK08
 windage area AW 0.034 m²

corrosion-resistant die cast aluminium housing AlSi12, polyester powder coated, lense made of high efficiency, UV stabilized optical silicon, all exterior steel parts are stainless steel, tempered safety glass, silicon gasket, closure with 3 stainless steel screws, for installation on poles Ø 60 - 100 mm, tiltable base made of powder coated aluminium, 2 drilled holes Ø 9 mm, spacing 95 mm, 1 drilled hole Ø 13.5 mm, tilt range 90°, swivel range 360°, M20 cable gland, integral driver (AC/DC)

Monospot 3 pole luminaire, Street Optic

Part number	Colour	Weight	Light source	Luminous flux	Beam angle γ (FWHM)	
8 903 246 089	black	4.1 kg	1 x LED module 36 W warm white (3000 K)	3236 lm	C 0 – 180	C 90 – 270
8 903 266 089	white				51°	121°
8 903 256 089	silver grey					

Part number	Colour	Weight	Light source	Luminous flux	Beam angle γ (FWHM)	
8 903 245 089	black	4.1 kg	1 x LED module 36 W neutral white (4000 K)	3374 lm	C 0 – 180	C 90 – 270
8 903 265 089	white				51°	121°
8 903 255 089	silver grey					

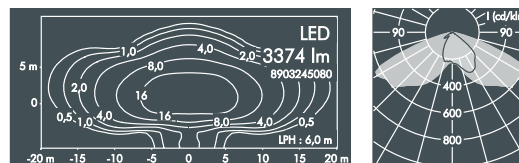
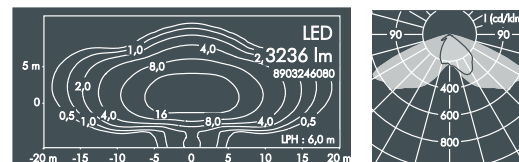

Part number	Description
. . . 7	Protection class II luminaire
. 1..	Dimmable luminaire (DALI)

Illumination examples (according to DIN EN 13201-2)

	Lighting situation			
	S(P)2	S(P)3	S(P)4	S(P)5
LPH	6 m	6 m	6 m	6 m
D	30 m	35 m	37 m	41 m
D/H	5	5,8	6,2	6,8
Em	9,3 lx	8 lx	7,5 lx	6,8 lx
Emin	3,1 lx	1,5 lx	1,0 lx	0,6 lx
Emin/Em	0,33	0,19	0,13	0,1
TI*	11%	12%	13%	14%





* TI: Threshold Increment (unit for measuring glare).
 A low TI value indicates a low glare factor.

LED (see page 247)

Luminaires available in 2700 K or other colour temperatures upon request



Monospot 4 pole luminaire

With high performance LED module (Zhaga), integral temperature monitoring device, CRI: > 85, Colour tolerance: 2 SDCM
 Service life: L90/B10 > 50 000 h
 protection class I or II, IP67    , IK08
 windage area AW 0.051 m²
 corrosion-resistant die cast aluminium housing AlSi12, polyester powder coated,
 highly efficient aluminium reflector or lens made of optical silicon (Street Optic),
 all exterior steel parts are stainless steel, tempered safety glass, silicon gasket,
 closure with 3 stainless steel screws, for installation on poles Ø 60 - 100 mm,
 tiltable base made of powder coated aluminium, 2 drilled holes Ø 9 mm, spacing 95 mm,
 1 drilled hole Ø 13.5 mm, tilt range 90°, swivel range 360°, M20 cable gland,
 integral driver (AC/DC)

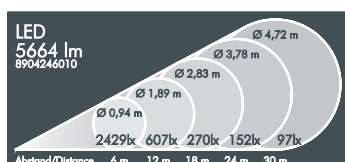
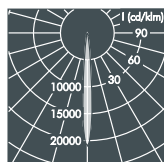
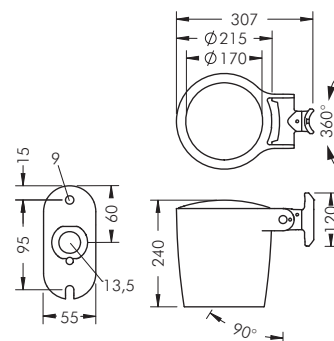

Monospot 4 pole luminaire, narrow beam

Part number	Colour	Weight	Light source	Luminous flux	Beam angle γ (FWHM)
8 904 246 019	black	5.2 kg	1 x LED module 70 W warm white (3000 K)	5664 lm	9°
8 904 266 019	white				
8 904 256 019	silver grey				

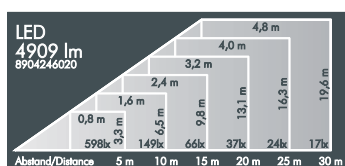

Monospot 4 pole luminaire, linear beam spread, vertical

Part number	Colour	Weight	Light source	Luminous flux	Beam angle γ (FWHM)
8 904 246 029	black	5.2 kg	1 x LED module 70 W warm white (3000 K)	4909 lm	C 0 - 180
8 904 266 029	white				C 90 - 270
8 904 256 029	silver grey				36°

... 3. Luminaire with linear beam spread, horizontal

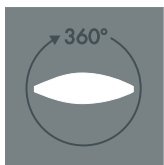

Monospot 4 pole luminaire, linear beam spread, rotatable

Part number	Colour	Description	Luminous flux	Beam angle γ (FWHM)
8 904 246 079	black	Luminaire with external ribbed glass spreader lens, continuously adjustable through 360° from outside the luminaire	4517 lm	C 0 - 180
8 904 266 079	white			C 90 - 270
8 904 256 079	silver grey			36°

Weight 5.4 kg

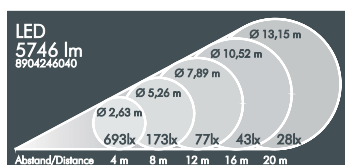
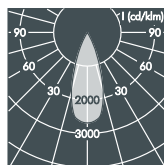

Monospot 4 pole luminaire, medium wide beam

Part number	Colour	Weight	Light source	Luminous flux	Beam angle γ (FWHM)
8 904 246 049	black	5.2 kg	1 x LED module 70 W warm white (3000 K)	5746 lm	36°
8 904 266 049	white				
8 904 256 049	silver grey				

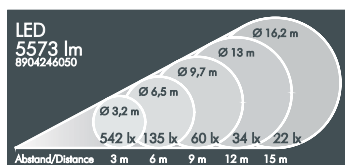
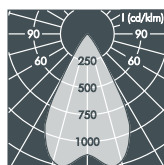

Monospot 4 pole luminaire, wide beam

Part number	Colour	Weight	Light source	Luminous flux	Beam angle γ (FWHM)
8 904 246 059	black	5.2 kg	1 x LED module 70 W warm white (3000 K)	5573 lm	57°
8 904 266 059	white				
8 904 256 059	silver grey				

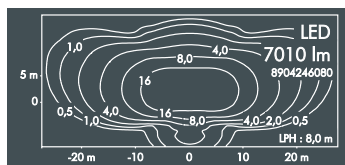
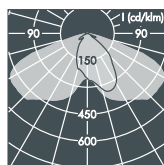

Monospot 4 pole luminaire, Street Optic

Part number	Colour	Weight	Light source	Luminous flux	Beam angle γ (FWHM)
8 904 246 089	black	5.4 kg	1 x LED module 70 W warm white (3000 K)	7010 lm	C 0 - 180
8 904 266 089	white				C 90 - 270
8 904 256 089	silver grey				51°

Part number	Description
. . . 8	Protection class II luminaire
. 5 . . .	Luminaire with neutral white colour temperature (4000 K)
. 1 . .	Dimmable luminaire (DALI)
Part number *	Description
. . . 4 . . 9 0 . .	Luminaire with LED module RGBW max. 49 W 
. . . 4 . . 2 1 . .	Luminaire with Tuneable White LED max. 37 W (2700 K - 6500 K)

* Not available for Monospot 4 pole luminaire, Street Optic

LED (see page 247)

Luminaires available in 2700 K or other colour temperatures upon request



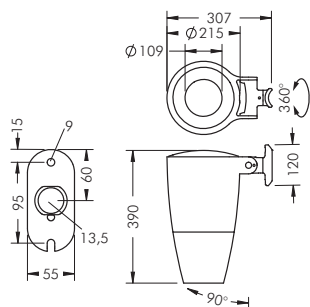

Monospot Gobo pole luminaire

With high performance LED module, CRI: > 70, colour tolerance: max. 4 SDCM service life: L70/B20 > 50 000 h protection class I, IP65 , IK08 windage area AW 0.076 m², corrosion-resistant die cast aluminium housing AlSi12, polyester powder coated, focusable lense, carrier for gobos and colour filters, all exterior steel parts are stainless steel, tempered safety glass, silicon gasket, closure with 3 stainless steel screws, for installation on poles Ø 60 - 100 mm, tilttable base made of powder coated aluminium, 2 drilled holes Ø 9 mm, spacing 95 mm, 1 drilled hole Ø 13.5 mm, tilt range 90°, swivel range 360°, M20 cable gland, integral driver (AC/DC)

Monospot Gobo pole luminaire, 63 mm focal length

Part number	Colour	Weight	Light source	Luminous flux	Beam angle
8 905 244 059	black	7.0 kg	1 x LED module 47 W cool white (6500 K)	1000 lm	30°
8 905 264 059	white				
8 905 254 059	silver grey				

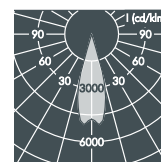
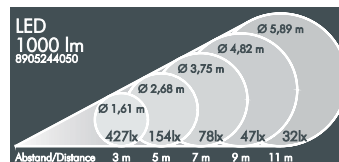

Monospot Gobo pole luminaire, 85 mm focal length

Part number	Colour	Weight	Light source	Luminous flux	Beam angle
8 905 244 049	black	7.0 kg	1 x LED module 47 W cool white (6500 K)	1095 lm	20°
8 905 264 049	white				
8 905 254 049	silver grey				

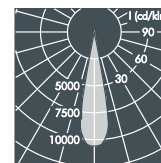
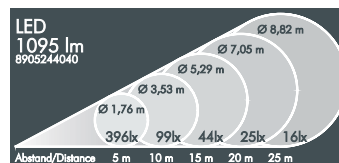

Monospot Gobo pole luminaire, 150 mm focal length

Part number	Colour	Weight	Light source	Luminous flux	Beam angle
8 905 244 019	black	7.0 kg	1 x LED module 47 W cool white (6500 K)	907 lm	12°
8 905 264 019	white				
8 905 254 019	silver grey				

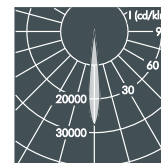
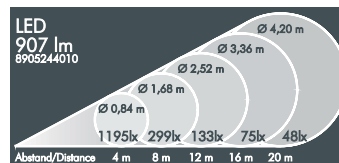

Part number	Description
. 1..	Dimmable version (DALI)
. 2..	Dimmable version (1-10 V)

LED (see page 247)



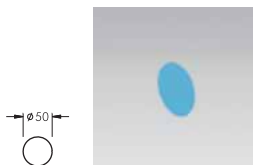

Accessories Monospot Gobo

Part number	Colour	Description
129 0 551 000	yellow	Dichroic colour filter
129 0 557 000	red	
129 0 553 000	blue	
129 0 558 000	green	

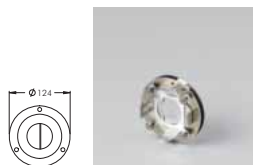

Part number	Description
129 0 780 000	Framer for sharp edges on 3- or 4-sided images



Part number	Example	Description
129 0 489 000	waves	Standard gobos Ø 50 mm
129 0 490 000	stars	
129 0 491 000	hash	

Custom made gobos can be produced from image data in one of the following file formats: **EPS** (min. 300 dpi), **TIF** (min. 300 dpi), **JPG** (in low compression).
Max. image size D on gobo: D = 38 mm (outer diameter gobo 50 mm)

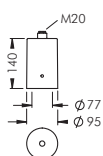
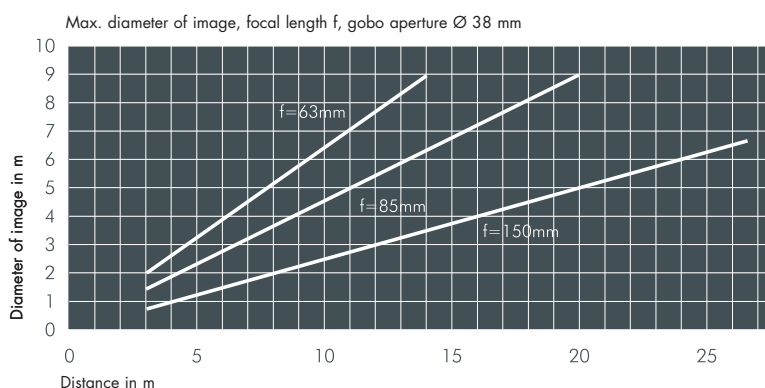

Part number	Colour	Description
128 0 626 940	black	Pole Top Filter , aluminium, for 76 mm pole top, with M20 x 1.5 connection thread, for installation of one projector with mounting bracket
128 0 626 960	white	
128 0 626 950	silver grey	



Monospot 2

Part number	Description
129 0 728 940	Radial louvre , internal (factory fitted), to reduce lateral glare



Monospot 3

Part number	Description
129 0 729 940	Radial louvre , internal (factory fitted), to reduce lateral glare



Monospot 4

Part number	Description
129 0 730 940	Radial louvre , internal (factory fitted), to reduce lateral glare



Monospot 1, 2

Part number	Luminaire	Description	Beam angle γ (FWHM)	
			narrow beam	medium wide beam
129 0 732 000	Monospot 1	Prismatic glass ,	15°	41°
129 0 733 000	Monospot 2	for diffused light distribution	17°	38°



Monospot 3, 4

Part number	Luminaire	Description	Beam angle γ (FWHM)	
			narrow beam	medium wide beam
129 0 734 000	Monospot 3	Prismatic glass ,	18°	37°
129 0 735 000	Monospot 4	for diffused light distribution	19°	46°

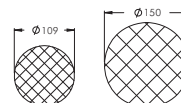

Monospot 1, 2

Part number	Luminaire	Description
129 0 751 000	Monospot 1	Honeycomb louvre , internal (factory fitted),
129 0 752 000	Monospot 2	to avoid glare



Monospot 3, 4

Part number	Luminaire	Description
129 0 753 000	Monospot 3	Honeycomb louvre , internal (factory fitted),
129 0 754 000	Monospot 4	to avoid glare

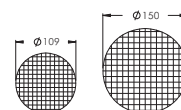

Since the LED modules are located deep inside the reflectors, the luminaires have good cut-off and excellent glare control. Accessories, such as louvres and optical glasses, are internally fitted and therefore maintenance-free.

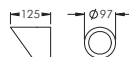

Monospot 1

Part number	Colour	Description
129 0 722 940	black	Cowl , stainless steel, to avoid lateral glare, for retro-fitting
129 0 722 960	white	
129 0 722 950	silver grey	



Monospot 2

Part number	Colour	Description
129 0 723 940	black	Cowl , stainless steel, to avoid lateral glare, for retro-fitting
129 0 723 960	white	
129 0 723 950	silver grey	

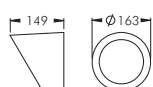

Monospot 3

Part number	Colour	Description
129 0 724 940	black	Cowl , stainless steel, to avoid lateral glare, for retro-fitting
129 0 724 960	white	
129 0 724 950	silver grey	

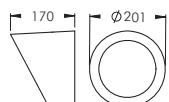

Monospot 4

Part number	Colour	Description
129 0 725 940	black	Cowl , stainless steel, to avoid lateral glare, for retro-fitting
129 0 725 960	white	
129 0 725 950	silver grey	

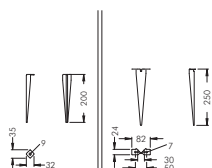

Monospot 1

Part number	Part number	Colour	Description
129 0 731 940	129 0 502 940	black	Stainless steel earth spike , for use in landscape lighting
129 0 731 960	129 0 502 960	white	
129 0 731 950	129 0 502 950	silver grey	

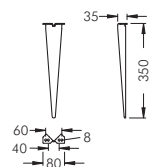

Monospot 3, 4

Part number	Colour	Description
129 0 736 940	black	Stainless steel earth spike , for use in landscape lighting
129 0 736 960	white	
129 0 736 950	silver grey	

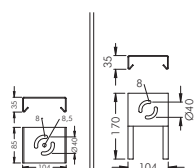

Monospot 1, 2

Part number	Part number	Description
120 0 620 940	120 0 622 940	Expandable tree strap with mounting plate , made of polyester fiber for trunk circumference 350 – 450 mm*, with polyester powder coated mounting plate

*different lengths available upon request

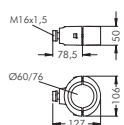

Monospot 2, 3, 4

Part number	Colour	Description
129 0 790 940	black	Single pole mount clamp , aluminium, for poles \varnothing 60 mm
129 0 790 960	white	
129 0 790 950	silver grey	

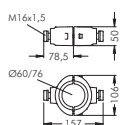

Part number	Colour	Description
129 0 792 940	black	Single pole mount clamp , aluminium, for poles \varnothing 76 mm
129 0 792 960	white	
129 0 792 950	silver grey	

Part number	Colour	Description
129 0 791 940	black	Double pole mount clamp , aluminium, for poles \varnothing 60 mm
129 0 791 960	white	
129 0 791 950	silver grey	

Part number	Colour	Description
129 0 793 940	black	Double pole mount clamp , aluminium, for poles \varnothing 76 mm
129 0 793 960	white	
129 0 793 950	silver grey	

