

BAULMANN LEUCHTEN

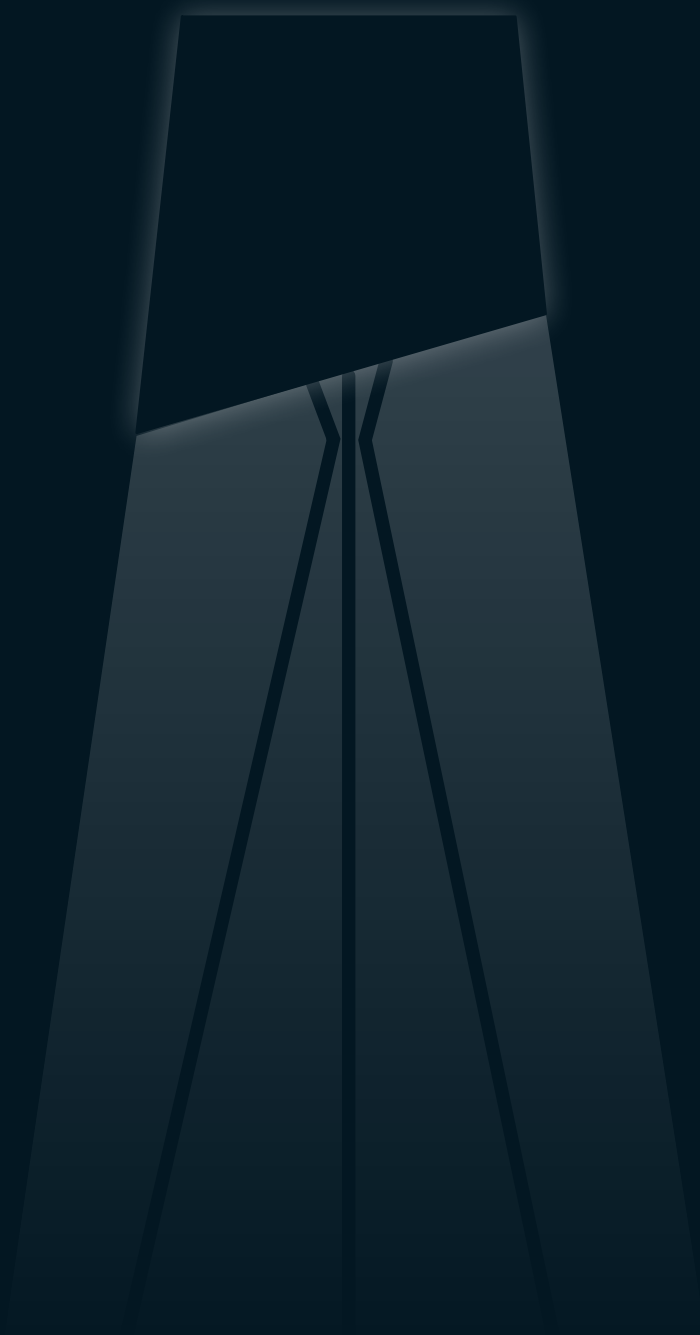



BAULMANN



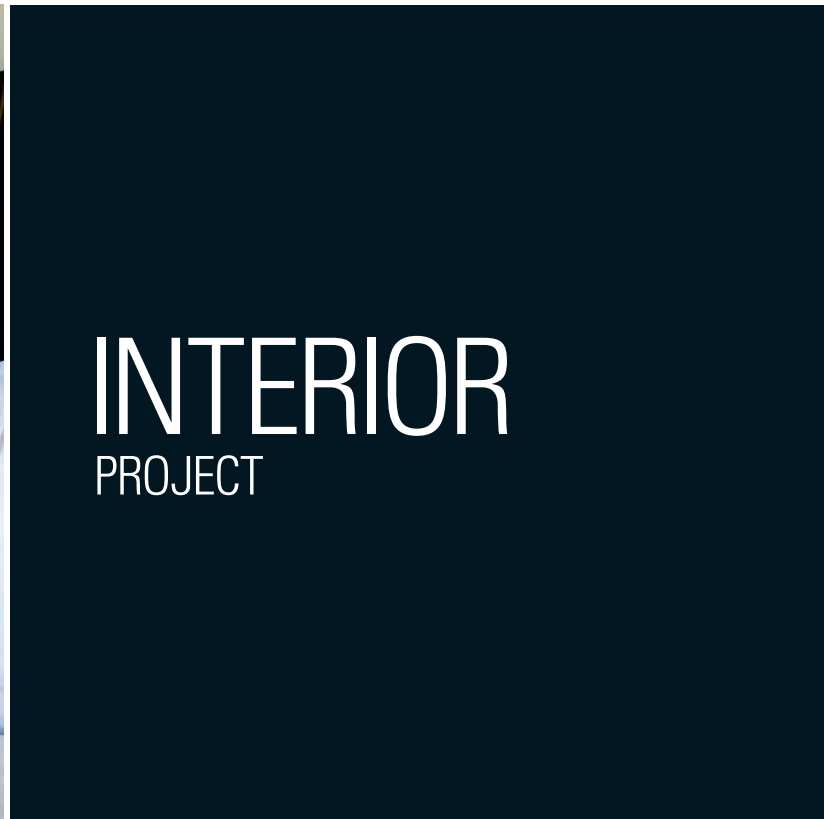
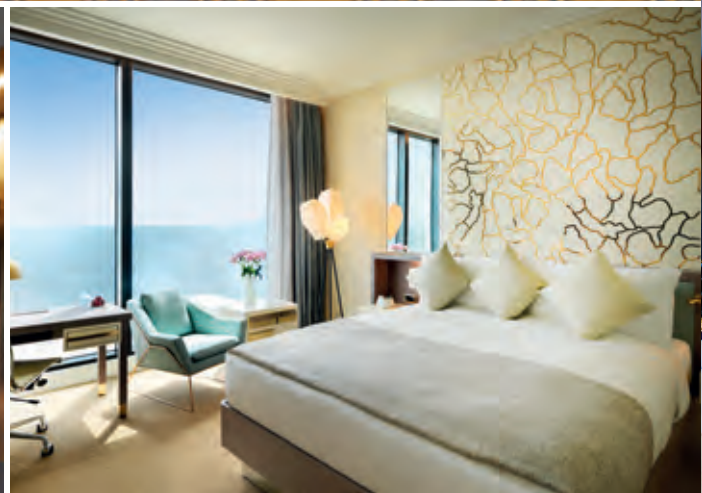
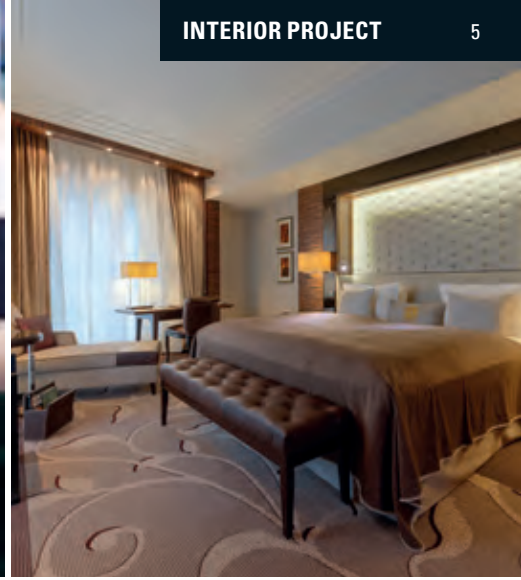

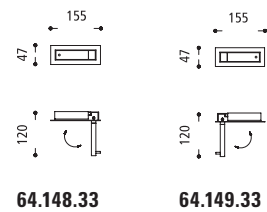

64.148.33

64.149.33

33 LED 3 W 2.700 K SNT extern

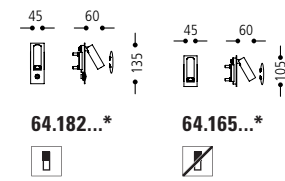

64.182...*

64.165...*

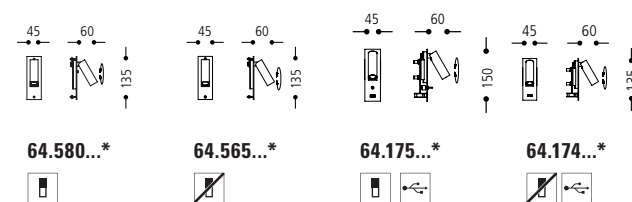

64.580...*

64.565...*

64.175...*

64.174...*

LED 1 W 3.000 K SNT extern

*Farbe / finish / couleur

03 05 14 15 33 54



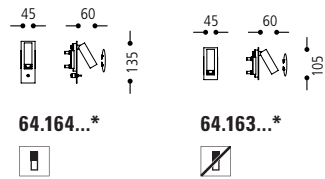

LED 1 W 3.000 K SNT

*Farbe / finish / couleur

- 03
- 05
- 14
- 15
- 33
- 54

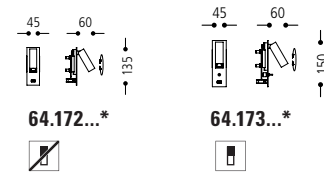

LED 1 W 3.000 K SNT

*Farbe / finish / couleur

- 03
- 05
- 14
- 15
- 33
- 54



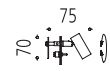

64.349...*

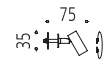

64.348...*

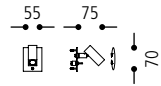

64.502...*

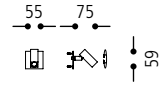

64.501...*



LED 1 W 3.000 K SNT extern

*Farbe / finish / couleur

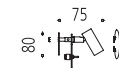

64.351...*

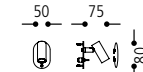

64.506...*

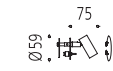

64.364...*

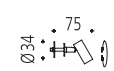

64.363...*



LED 1 W 3.000 K SNT extern

*Farbe / finish / couleur



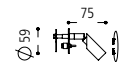

64.360...*

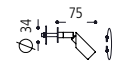

64.359...*



64.354...*



64.353...*



LED 1 W 3.000 K SNT extern

*Farbe / finish / couleur

03 05 14 15 54





64.340...*

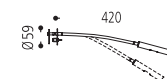

64.347...*



*Farbe / finish / couleur

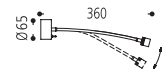

64.341...*



*Farbe / finish / couleur



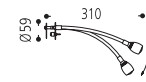

64.345.69

69 LED 1 W 3.000 K SNT extern

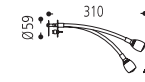

64.345...*

SNT extern

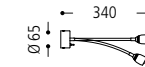

64.361...*

SNT

LED 1 W 3.000 K

*Farbe / finish / couleur

37 64 65 69



Natur pur

- Klimapfad
- Jugetbach
- Waldkindergarten
- Schaukelbank
- Waldluft
- Schwalbennest
- Waldhängematten
- Waldtreppe
- Bergquelle
- Kräuterwiese

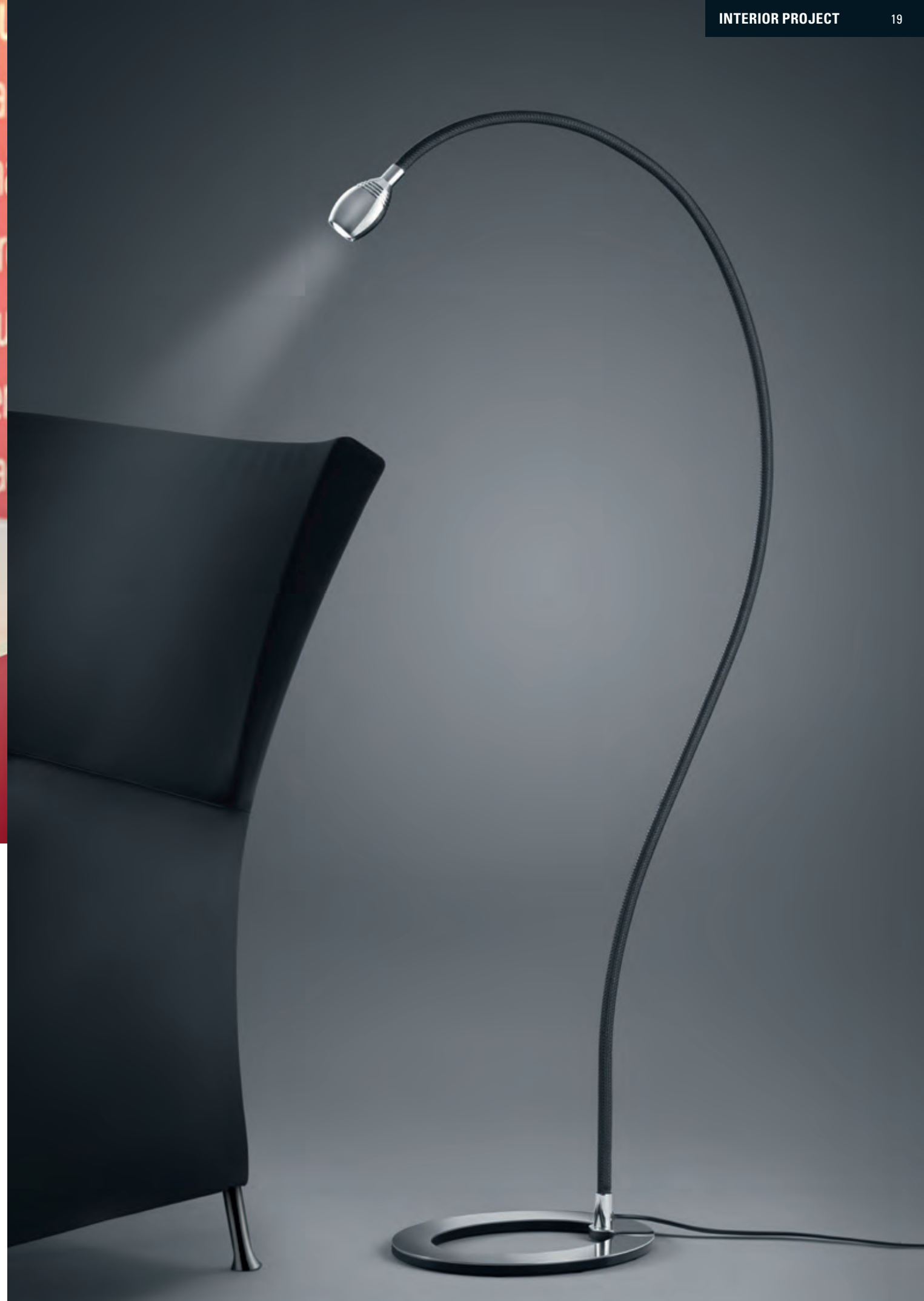

24.345...*

LED 4 W	3.000 K	SNT
---------	---------	-----

*Farbe / finish / couleur

37	64	65	67	69
----	----	----	----	----



14.345...*

LED 4 W 3,000 K SNT

*Farbe / finish / couleur

- 37
- 64
- 65
- 67
- 69

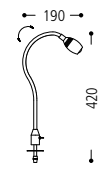

14.346...*

LED 4 W 3,000 K SNT extern

*Farbe / finish / couleur

- 37
- 64
- 65
- 67
- 69



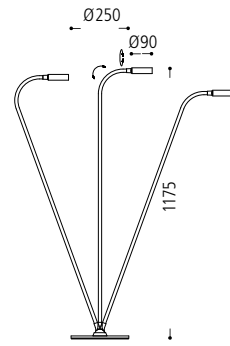

24.107...*

LED 6 W 3.000 K SNT

*Farbe / finish / couleur

38 55 69

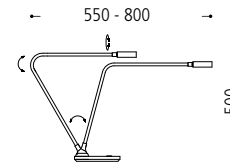

14.107...*

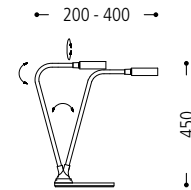

14.106...*

LED 6 W 3.000 K SNT

*Farbe / finish / couleur

38 55 69



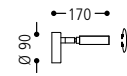

64.109...*

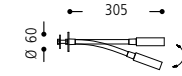

64.108...*

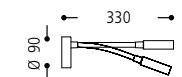

64.110...*



*Farbe / finish / couleur

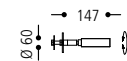

64.107...*



*Farbe / finish / couleur





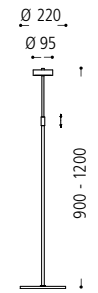

24.108.69

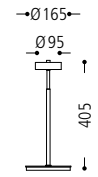

14.108.69

69 LED 6 W SNT

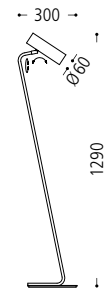

24.129.01

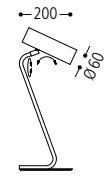

14.129.01

01 GU10



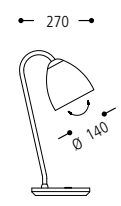

14.245.69

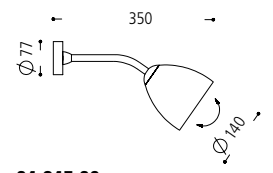

64.245.69

69 GX53 LED 5 W

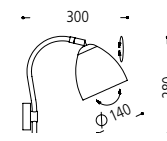

64.246...*

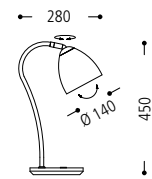

14.246...*

GX53
LED 5 W

*Farbe / finish / couleur

55 69

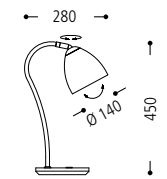

14.249...*

GX53
LED 5 W

*Farbe / finish / couleur

55 69



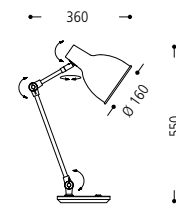

14.244...*

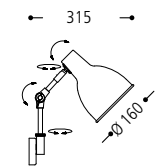

64.244...*

E27

*Farbe / finish / couleur

55 69

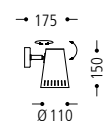
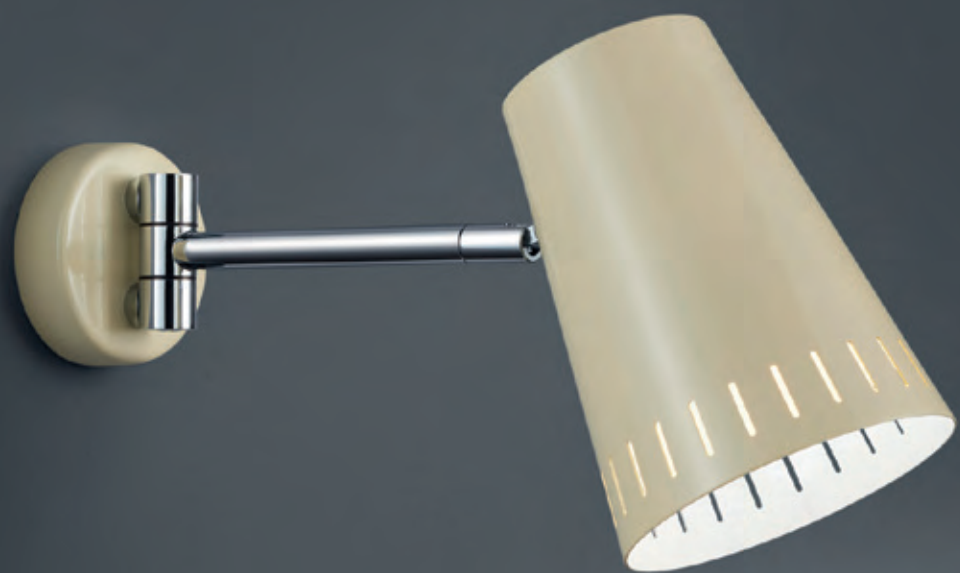

64.234...*

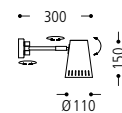

64.235...*

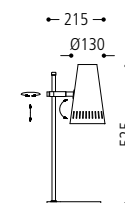

14.234...*

GX53
LED S W

*Farbe / finish / couleur



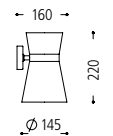

63.326...*-...**

** Schirm / shade / ABJ

139 4208 135 4207

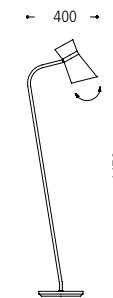

23.326...*-...**

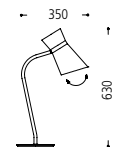

13.326...*-...**

** Schirm / shade / ABJ

139 4205 135 4204

GX53
LED 5 W

*Farbe / finish / couleur

03 69



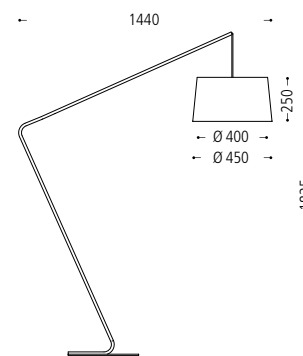

23.159.69-4048

69 E27

Schirm / shade / ABJ

150

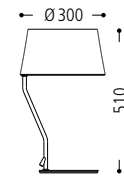
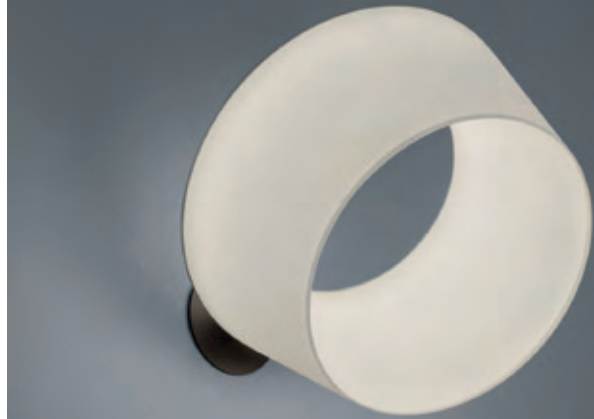

13.703.69-4230

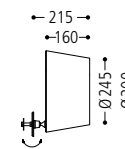

63.703.69-4230



23.703.69-4229

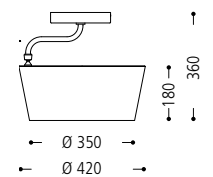

83.703.69-4229

69 LED 6 W 3.000 K

Schirm / shade / ABJ

135

69 LED 15 W 3.000 K SNT

Schirm / shade / ABJ

135

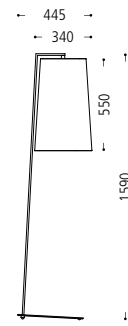

23.155.69-4310

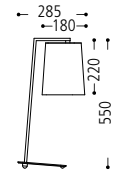

13.155.69-4311

69 E27

Schirm / shade / ABJ

144

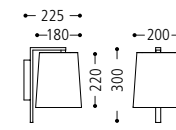

63.155.69-4311

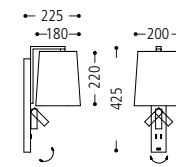

63.156.69-4311

+ LED 1 W 3.000 K SNT

69 E27

Schirm / shade / ABJ

144



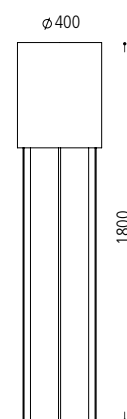

23.160...*-4049

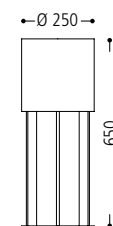

13.160...*-4050

E27

*Farbe / finish / couleur

19 33 54

Schirm / shade / ABJ

135

Design: Iria Degen



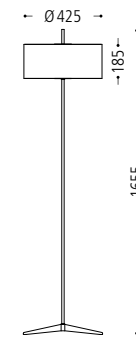
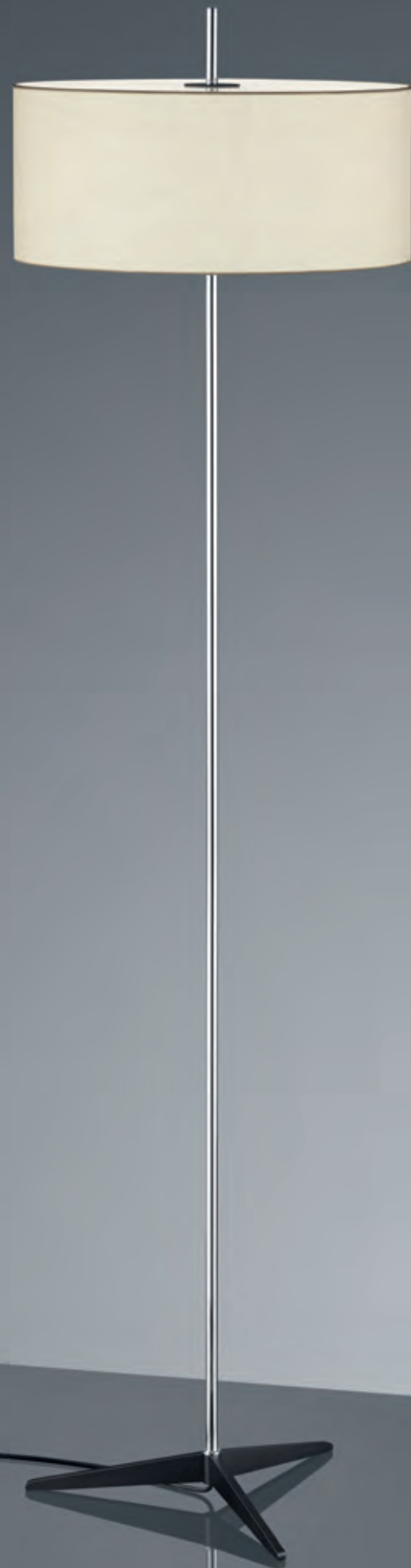

23.327.69-4045

3 x E27

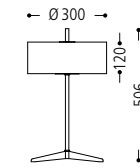

13.327.69-4046

3 x E14

69

Schirm / shade / ABJ

144

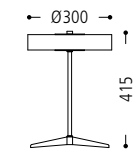

13.728.69-4047

69 LED 10 W 3.000 K SNT

Schirm / shade / ABJ

143





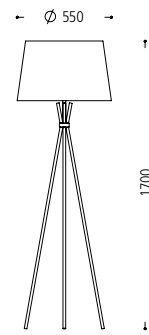

23.158...*-...**

E27

*Farbe / finish / couleur

03 30 33

** Schirm / shade / ABJ

135 4001 139 4043

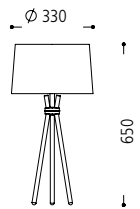
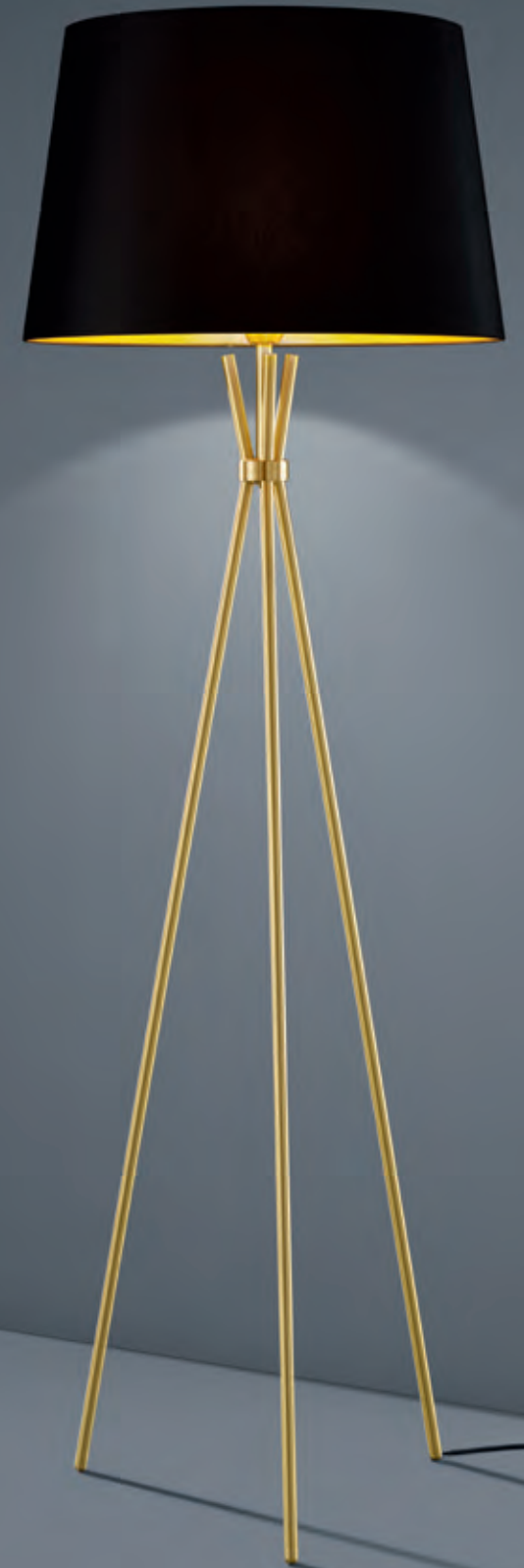
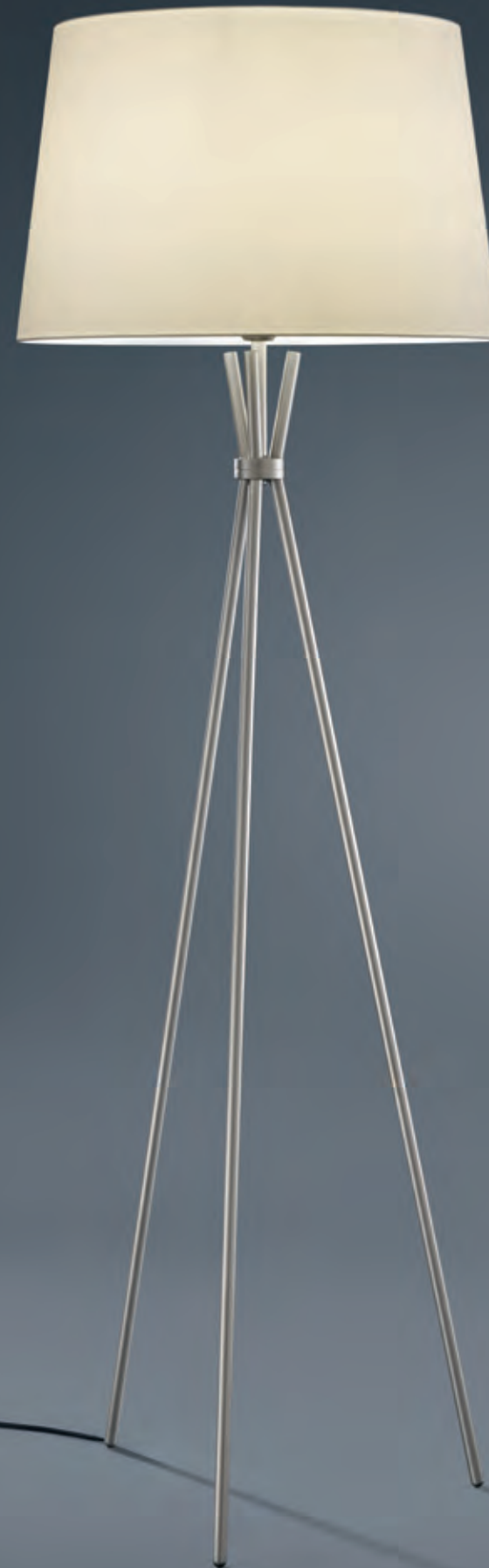

13.158...*-...**

E27

*Farbe / finish / couleur

03 30 33

** Schirm / shade / ABJ

135 4007 139 4044

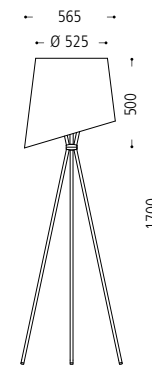

23.158...*-4224



13.158...*-4225

E27

* Farbe / finish / couleur



Schirm / shade / ABJ



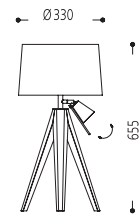

13.157.69-....*

69 E27 + GU10

* Schirm / shade / ABJ

135 4007 128 4009

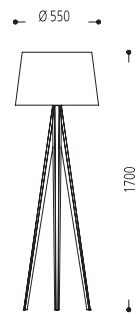
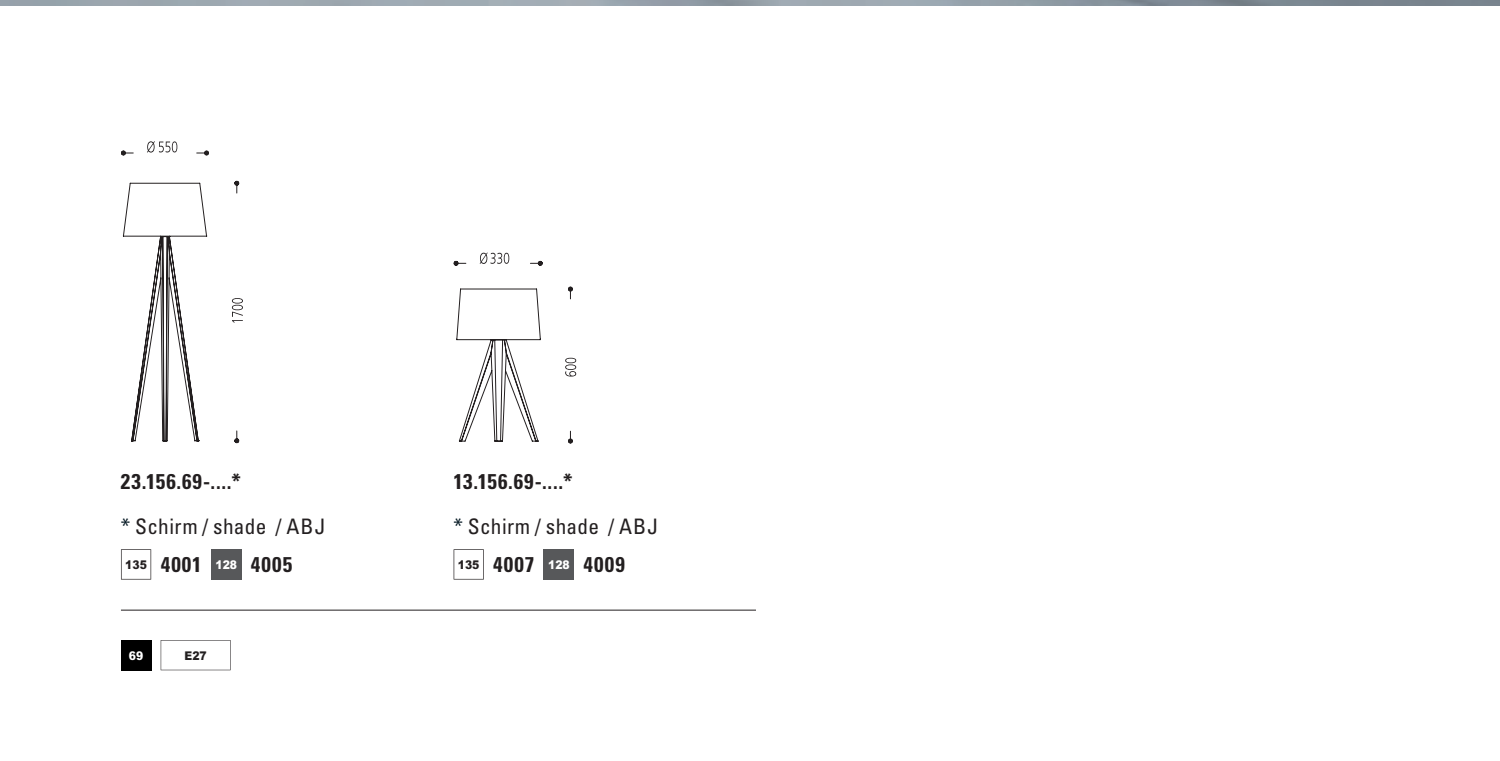

23.156.69-....*

* Schirm / shade / ABJ

135 4001 128 4005

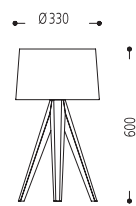

13.156.69-....*

* Schirm / shade / ABJ

135 4007 128 4009

69 E27



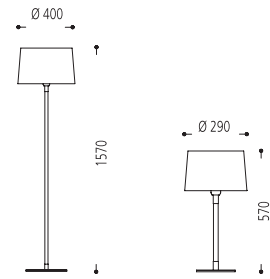

23.323...*-4036 13.323...*-3886

E27

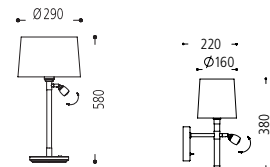

13.325...*-3886 63.324...*-4042

E27

E14

+ LED 1 W 3.000 K SNT

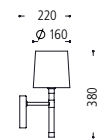

63.323...*-4042

E14

* Farbe / finish / couleur

37 64 65 69

Schirm / shade / ABJ

135





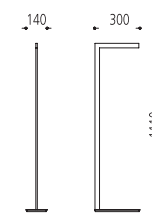

24.157.33
LED 3 W

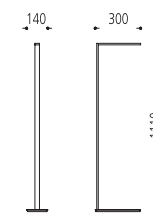

24.156.33
LED 3 W

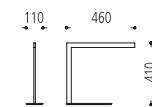

14.157.33
LED 6 W

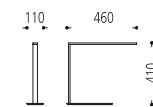

14.156.33
LED 6 W

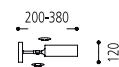

64.400.14

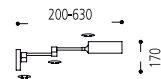

64.420.14

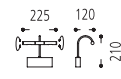

64.057.30

LED 6 W

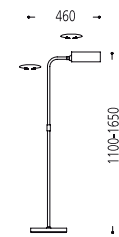

24.400.14

14 E27

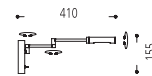

64.155.30

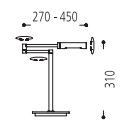

14.155.30

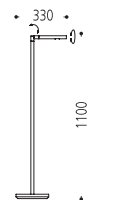

24.154.30

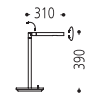

14.154.30

30 LED 3 W 2.700 K SNT

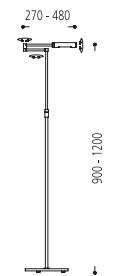

24.155.30

LED 3 W

30 2.700 K SNT



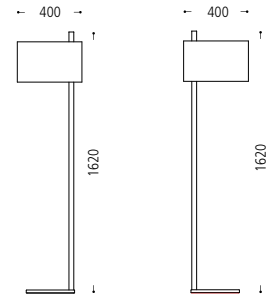

23.704.30-2023 23.705.30-2023

LED 12 W

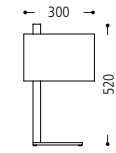

13.705.30-2024

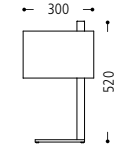

13.704.30-2024

30 LED 9 W 3.000 K SNT

Schirm / shade / ABJ

135

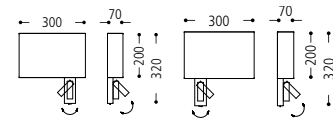

63.704.30-2026 63.705.30-2027

LED 9 W + LED 1 W

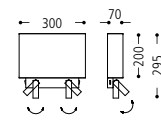

63.706.30-2025

LED 9 W + 2 x LED 1 W

30 3.000 K SNT

Schirm / shade / ABJ

135



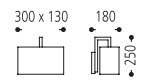

63.150.33-3845

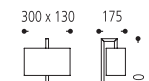

13.150.33-3845

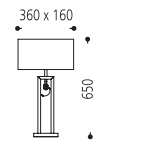

13.153.33-3847

+ LED 1 W 3.000 K SNT

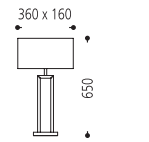

13.152.33-3847

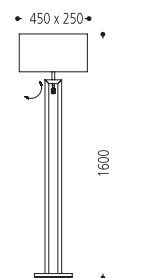

23.153.33-3848

+ LED 1 W 3.000 K SNT

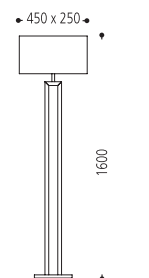

23.152.33-3848

33 E27

Schirm / shade / ABJ

135



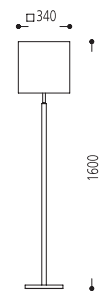

25.140.41-4127

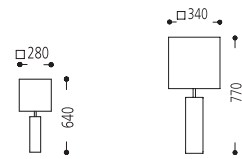

15.140.41-4126 15.141.41-4127

41 E27

Schirm / shade / ABJ

135

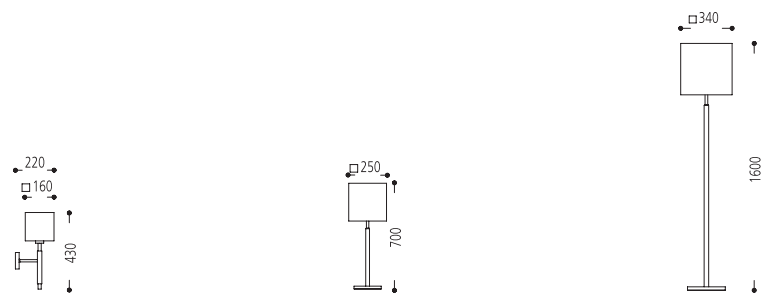

63.154.82-4131

13.154.82-4125

23.154.82-4127

82 E27

Schirm / shade / ABJ

135

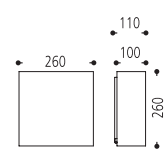
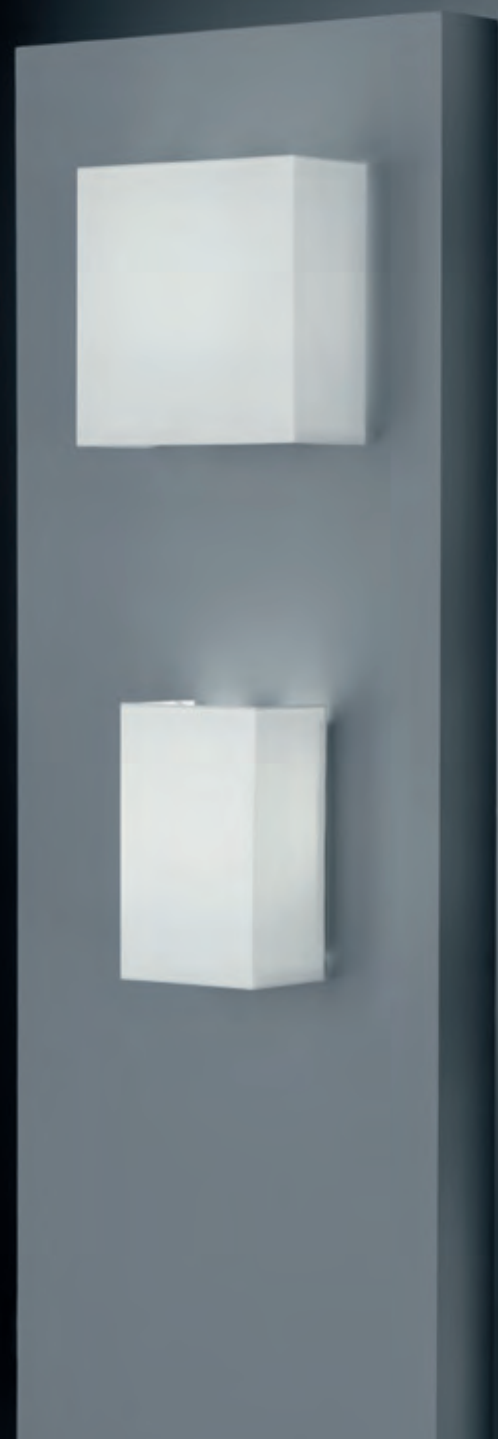

64.831.55-2092

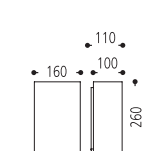

64.831.55-2090

55

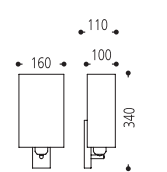

63.301.30-2091

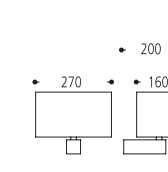

63.320.30-3840

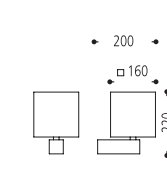

63.320.30-4131

30

E27

Schirm / shade / ABJ

135

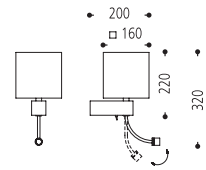

63.321.30-4131

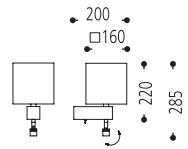

63.322.30-4131

30

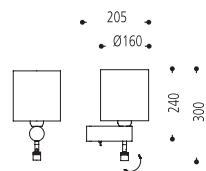

63.148.19-4038

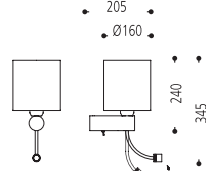

63.147.19-4038

19

E27 + LED 1 W 3,000 K SNT

Schirm/shade / ABJ

135





63.311.30-3913



63.312.30-3915

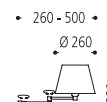

63.313.30-3915



Schirm / shade / ABJ

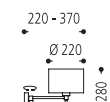

63.315...*-3858

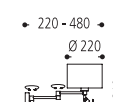

63.319...*-3858



*Farbe / finish / couleur



Schirm / shade / ABJ



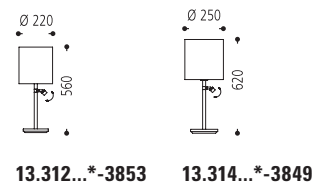

13.312...*-3853

13.314...*-3849

+ LED 1 W 3,000 K SNT

270 - 610

Ø 270



13.315...*-3854

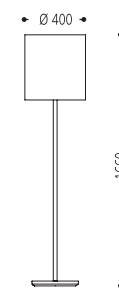

23.311...*-3856

E27

350 - 680

Ø 350



23.315...*-3855

E27

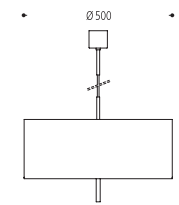

33.311...*-3857

E27

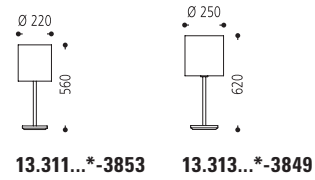

13.311...*-3853

13.313...*-3849

E27

*Farbe / finish / couleur

19 30

Schirm / shade / ABJ

135

Ø 340



1600

23.131...*-4822

G5 28 W EVG

*Farbe / finish / couleur

19 30

Schirm / shade / ABJ

135





63.409.15-3879

E14



13.409.15-3878

E27

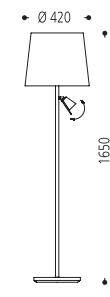

23.409.15-3877

E27

15 + GU10

Schirm / shade / ABJ

135

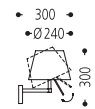

63.310.15-3883

E14

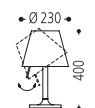

13.309.15-3881

E27

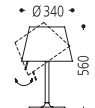

13.310.15-3884

E27

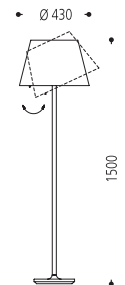

23.310.15-3885

E27

15

Schirm / shade / ABJ

135

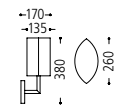

63.108.15-3646

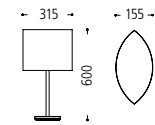

13.311.15-3641

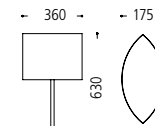

13.313.15-3642

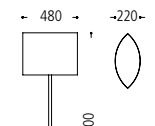

23.311.15-3644

15

E27

Schirm / shade / ABJ

131



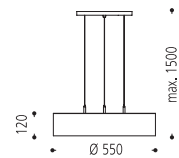

33.751.15-3810

LED 35 W 3.000 K SNT

15

Schirm / shade / ABJ

140

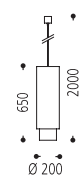

33.208.15-3690

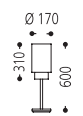

13.208.15-3687

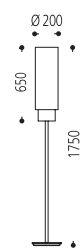

23.208.15-3688

15 E27

Schirm / shade / ABJ

140 135

Schirmmaterial: Leinenstruktur 140 (außen), Chintz naturweiß 135 (innen) /
 shade: linen-structure 140 (outside), chintz off white 135 (inside) /
 ABJ: toile-structure 140 (dehors), chintz blanc 135 (à l'intérieur)



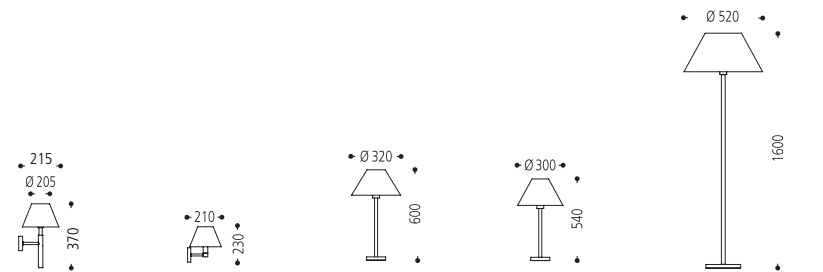

63.317.30-3836 63.316.30-3836 13.317.30-3832 13.316.30-3830 23.316.30-3838

E14

E27

30

Schirm / shade / ABJ

135



13.145.09-3698

E27

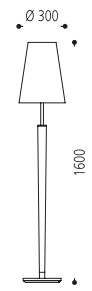

23.145.09-3700

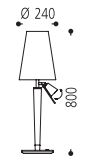

13.148.09-3698

E27 + GU10

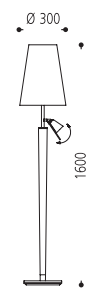

23.148.09-3700

09

Schirm / shade / ABJ

131

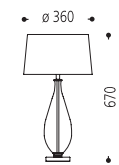

16.130.30-3834

30

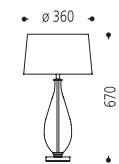

16.130.50-3834

50

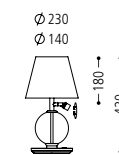

16.145.30-3881

30 + LED 1 W 3.000 K SNT

E27

Schirm / shade / ABJ

135



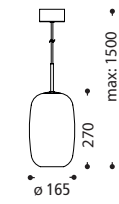

34.162...*-...**

**Glas / glass / verre

871 Klar / clear / clair

872 Rauch / smoke / fumé

873 Amber / amber / ambré

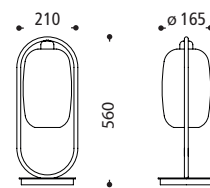

14.162...*-...**

E27

*Farbe / finish / couleur

03 69

**Glas / glass / verre

871 Klar / clear / clair

872 Rauch / smoke / fumé

873 Amber / amber / ambré

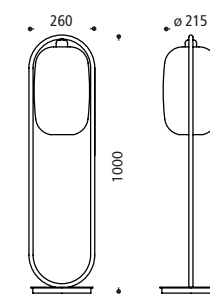

24.162...*-...**

**Glas / glass / verre

874 Klar / clear / clair

875 Rauch / smoke / fumé

876 Amber / amber / ambré

E27

*Farbe / finish / couleur

03 69



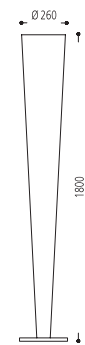

23.129...*-...**

G5 35 W

** Schirm / shade / ABJ

105 4817 135 4807

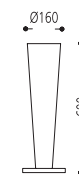

13.129...*-...**

G5 14 W

** Schirm / shade / ABJ

105 4816 135 4806

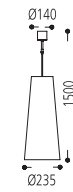

33.208.15-4818

15 E27

Schirm / shade / ABJ

105

EVG

*Farbe / finish / couleur

09 14

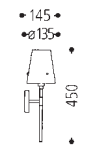

63.185.33-3567

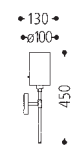

63.185.33-3557

E14

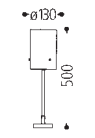

13.185.33-3551

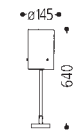

13.186.33-3552

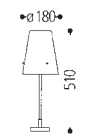

13.185.33-3561

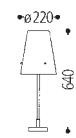

13.186.33-3562



23.185.33-3521



23.185.33-3554

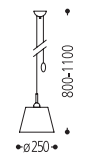

34.185.33-3568

E27

33

Schirm / shade / ABJ

710

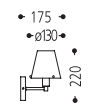

63.101...*-3565

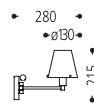

63.103...*-3565

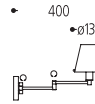

63.104...*-3565

E14

*Farbe / finish / couleur

30 33

Schirm / shade / ABJ

710



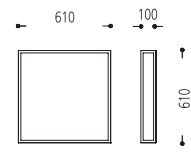

83.342.54

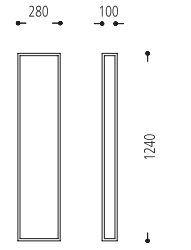

83.343.54

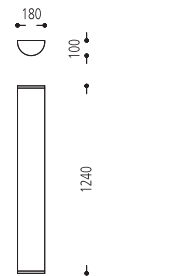

83.344.54

54	LED 25 W	3.000 K	SNT
----	----------	---------	-----

Schirm / shade / ABJ

200



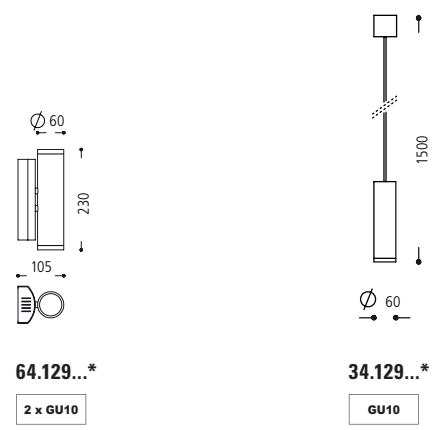
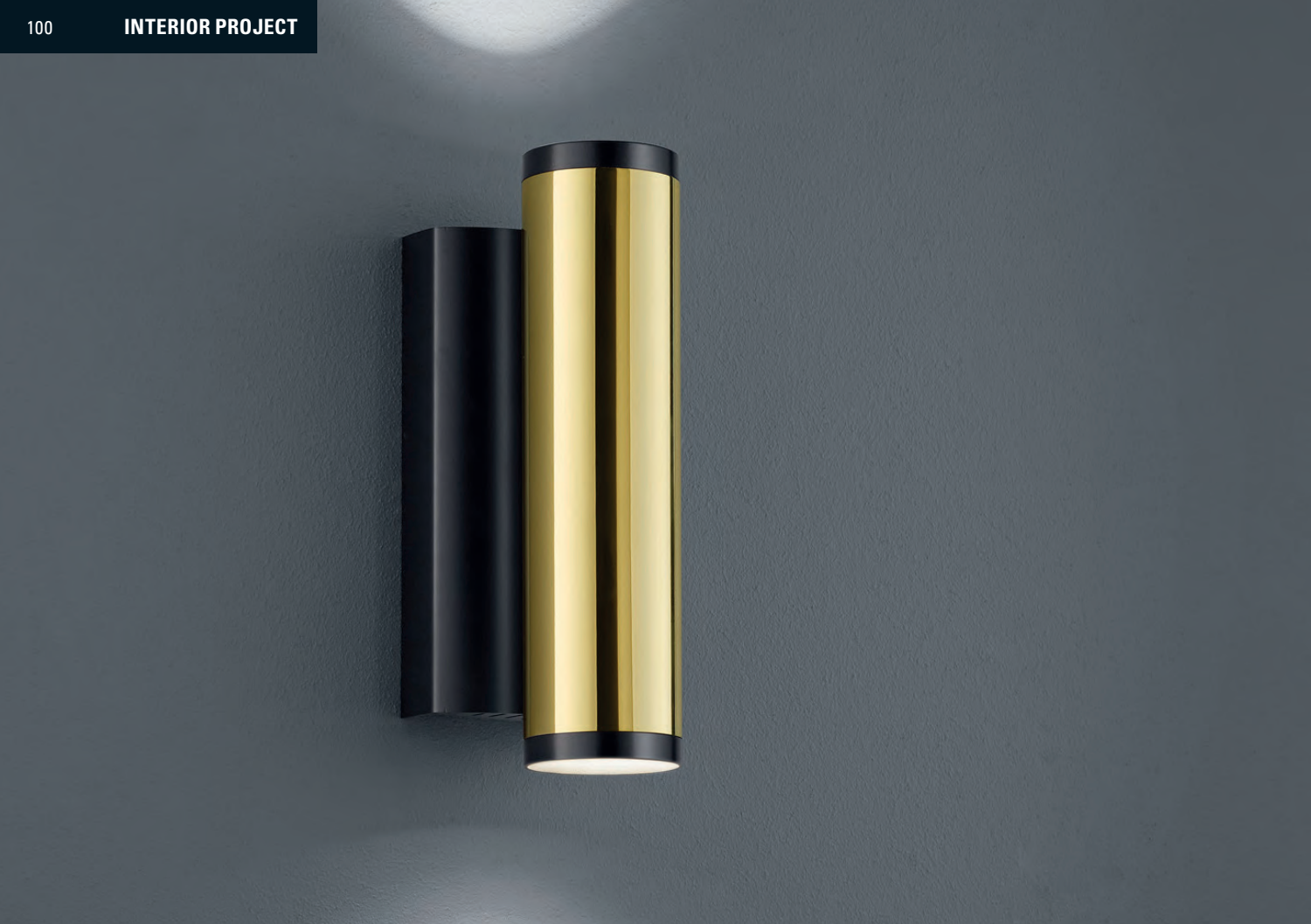

64.129...*
2 x GU10

34.129...*
GU10

*Farbe / finish / couleur





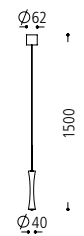

34.143...*

LED 4 W 3.000 K SNT

*Farbe / finish / couleur

55 69



34.286...*

GU5,3

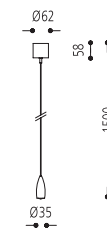

34.284...*

LED 4 W 3.000 K

SNT

*Farbe / finish / couleur

14 15 54



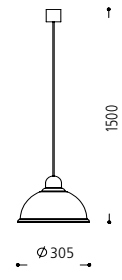

34.122.69

69	E27
----	-----



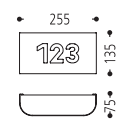
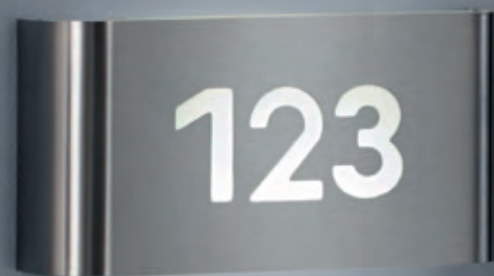

63.980.82

82 LED 5 W 3,000 K SNT

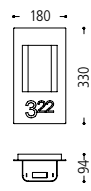

63.972...*

LED 6 W 2,700 K SNT

*Farbe / finish / couleur



Design: Studioarchitects

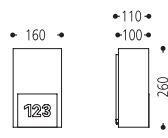

64.831.55-2086

55 E27

Schirm/shade / ABJ

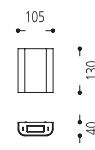

64.145...*

LED 6 W 2,700 K SNT

*Farbe / finish / couleur



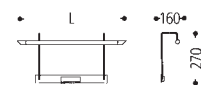

64.067...* L 550

64.068...* L 650

LED 5 W SNT

64.069...* L 750

64.070...* L 850

LED 7 W SNT



64.063...* L 525

64.064...* L 625

LED 5 W SNT
extern

64.065...* L 725

64.066...* L 825

LED 7 W SNT
extern

64.040...* L 540

64.050...* L 640

LED 5 W SNT

3.000
K

*Farbe / finish / couleur

01 14

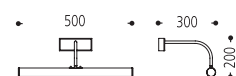

64.056.30

2 x E14

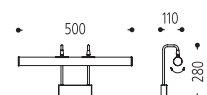

64.055.30

2 x E14

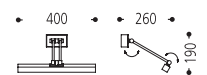

64.048.30

LED 4 W 3.000
K SNT

30



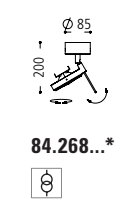

84.268...*

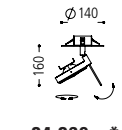

84.269...*

AR111
G53

*Farbe / finish / couleur

15 54



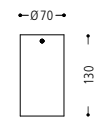
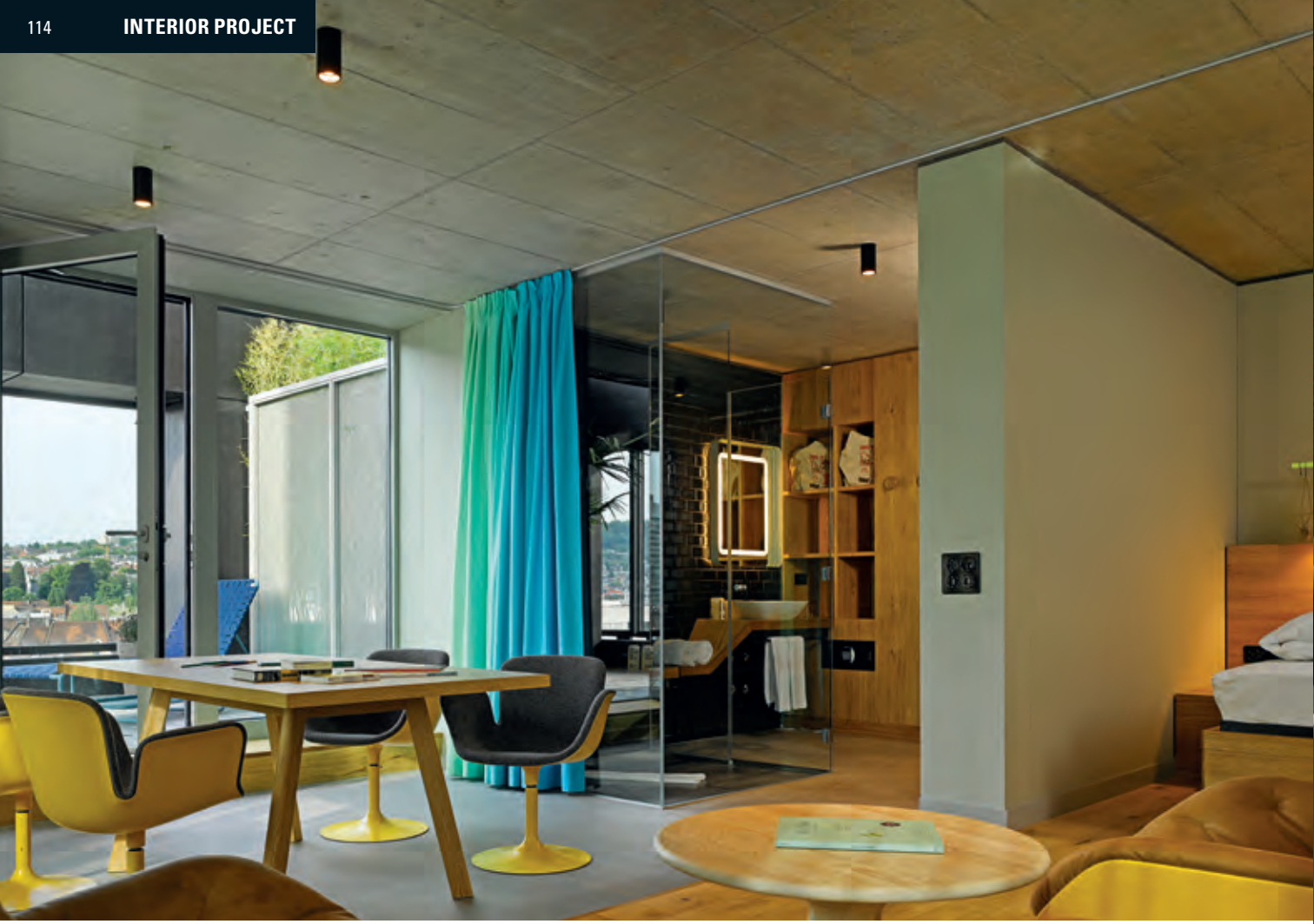

83.129...*

GU10

*Farbe / finish / couleur



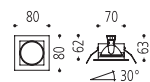

84.285.15

GU5,3



84.283.15

GU5,3

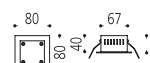

84.279.15-6004

QT9 G4 IP44

15

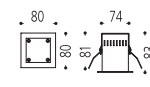

84.282.15-6004

GU5,3

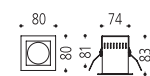

84.282.15

GU5,3



88.224.15

LED 1 W 3.000 K M M

15



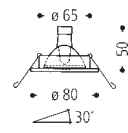

84.139.82

82

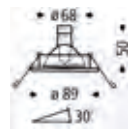

84.119...*

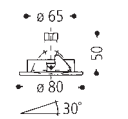

84.129...*

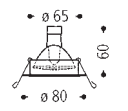

84.216...*

GU5,3

*Farbe / finish / couleur



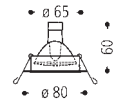

84.116...*

GU5,3

Zubehör / accessories / accessoires:
2860 Glassatz / glass-set / jeu de verre

IP44

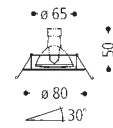

84.219...*

GU5,3

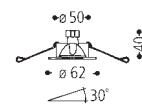

84.112...*

GU4

*Farbe / finish / couleur

01 14 55

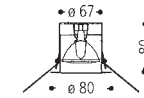

84.010...*

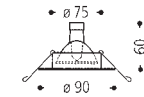

84.115...*

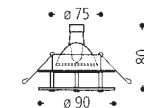

84.115...*-429

GU5,3

*Farbe / finish / couleur

01 14 55

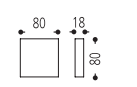
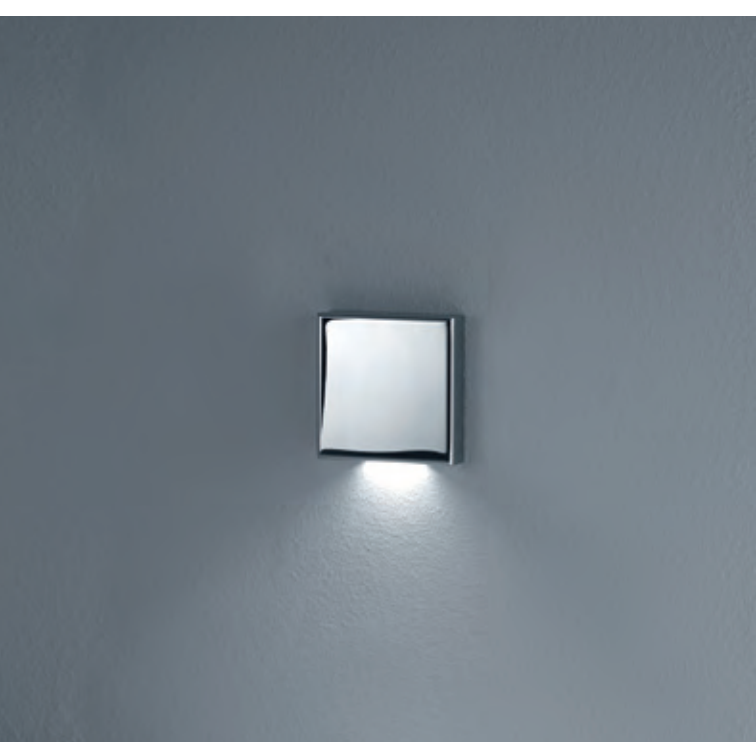

64.357...*

LED 3 W 2.700 K

*Farbe / finish / couleur

- 15
- 54
- 81



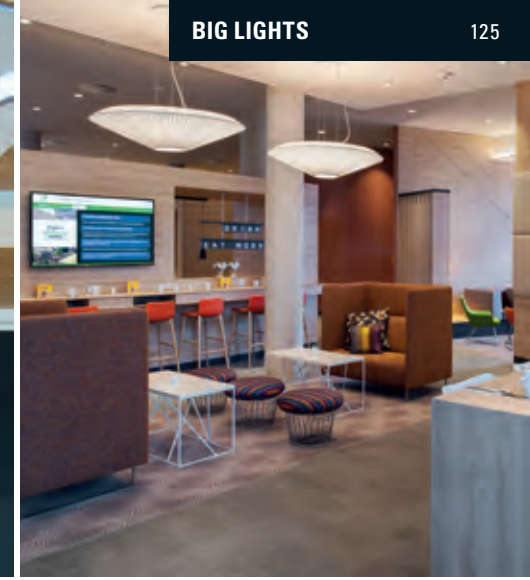

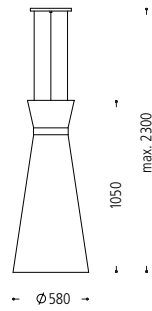

33.700...*...**

LED 15 W 3.000 K **SNT**

*Farbe / finish / couleur

15 55 **69**

** Schirm / shade / ABJ

135 4276

161 4277

139 4278

162 4279



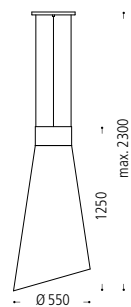

33.700...*...**

LED 15 W 3.000 K SNT

*Farbe / finish / couleur

15 55 69

** Schirm / shade / ABJ

144 4226

161 4227

162 4228



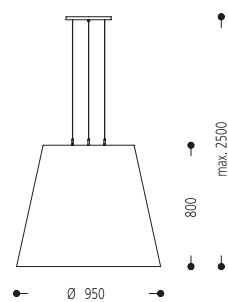

33.905.15-....*

*** 4269**

Schirmmaterial: Chintz champ 131 (außen) / Plissee champ 103 (innen)
 shade: chintz champ 131 (outside) / pleated champ 103 (inside)
 ABJ: chintz champ 131 (dehors) / plissé champ 103 (à l'intérieur)

*** 4270**

Schirmmaterial: Taft schwarz 136 (außen) / Taft gold 141 (innen)
 shade: taffeta black 136 (outside) / taffeta gold 141 (inside)
 ABJ: taffetas noir 136 (dehors) / taffetas d'or 141 (à l'intérieur)

*** 4271**

Schirmmaterial: Chintz schwarz (außen) / gold 139 (innen)
 shade: chintz black (outside) / gold 139 (inside)
 ABJ: chintz noir (dehors) / d'or 139 (à l'intérieur)

15 3 x E27



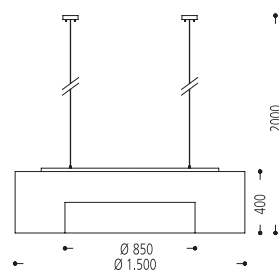

33.665.15-3715

5 x 2G11
55 W

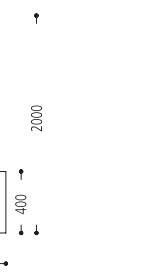

33.675.15-3715

5 x 2G11
55 W

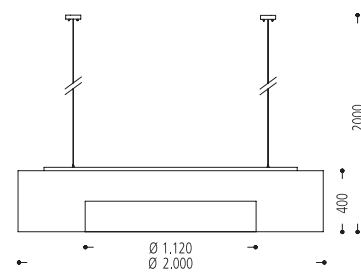

33.667.15-3717

6 x 2G11
55 W

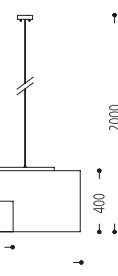

33.677.15-3717

6 x 2G11
55 W

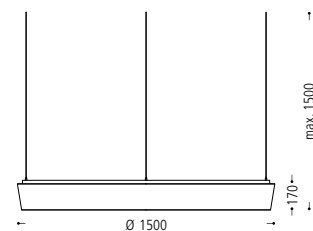

33.703.15-4233

LED 32 W



15

Schirm/shade / ABJ

135





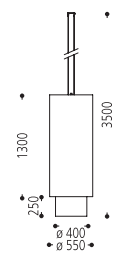

34.908.15-....*

*** 4294**

Schirmmaterial: Chintz gelb 132 (außen), Chintz weiß 130 (innen) /
 shade: chintz yellow 132 (outside), chintz white 130 (inside) /
 ABJ: chintz jaune 132 (dehors), chintz blanc 130 (à l'intérieur)

*** 4295**

Schirmmaterial: Chintz champ 131 (außen), Chintz weiß 130 (innen) /
 shade: chintz champ 131 (outside), chintz white 130 (inside) /
 ABJ: chintz champ 131 (dehors), chintz blanc 130 (à l'intérieur)

*** 4296**

Schirmmaterial: Chintz naturweiß 135 (außen), Chintz weiß 130 (innen) /
 shade: Chintz off white 135 (outside), chintz white 130 (inside) /
 ABJ: Chintz blanc 135 (dehors), chintz blanc 130 (à l'intérieur)

*** 4297**

Schirmmaterial: Contra H grob natur 105 (außen), Chintz weiß 130 (innen) /
 shade: contra H coarse nature 105 (outside), chintz white 130 (inside) /
 ABJ: contra H grossier nature 105 (dehors), chintz blanc 130 (à l'intérieur)



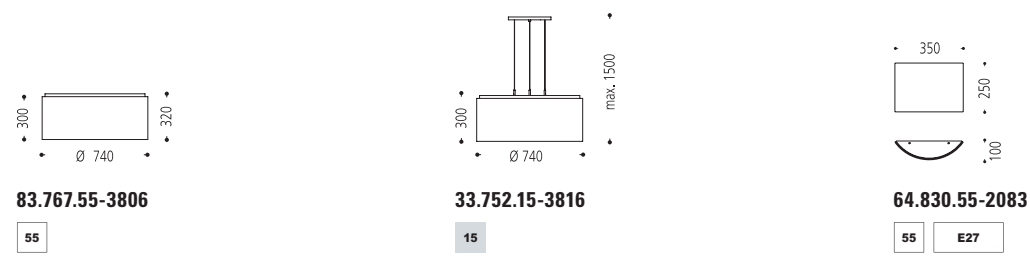

83.767.55-3806 **33.752.15-3816** **64.830.55-2083**

55 15 55 E27

LED 60 W 3,000 K SNT

Schirm / shade / ABJ
135

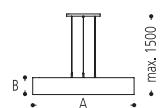

33.751.15-3810 A 550 B 120 **33.753.15-3812** A 940 B 150

LED 35 W

LED 85 W

33.752.15-3811 A 740 B 150 **33.754.15-3813** A 1.140 B 150

LED 60 W

LED 120 W

15 3.000 K SNT

Schirm/shade / ABJ

135

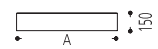

83.766.55-3803 A 550

LED 35 W

83.767.55-3804 A 740

LED 60 W

83.768.55-3805 A 940

LED 85 W



63.756.55-3720 A 550

LED 35 W

63.757.55-3721 A 740

LED 60 W

63.758.55-3722 A 940

LED 85 W

55 3,000 K SNT

Schirm / shade / ABJ

135



83.754.55-3801 A 300

LED 10 W

83.755.55-3802 A 400

LED 15 W



63.754.55-3718 A 300

LED 10 W

63.755.55-3719 A 400

LED 15 W

55 3,000 K SNT

Schirm / shade / ABJ

135



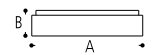

83.751.15 A 550 B 120
LED 35 W

83.752.15 A 740 B 150
LED 60 W

83.753.15 A 940 B 150
LED 85 W

83.756.15 A 1.140 B 150
LED 120 W

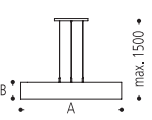

34.751.15 A 550 B 120
LED 35 W

34.759.15 A 740 B 150
LED 60 W

34.753.15 A 940 B 150
LED 85 W

34.754.15 A 1.140 B 150
LED 120 W

15 3,000 K SNT



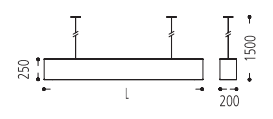

33.568.15-4259 L 1.000

G5 39 W

33.569.15-4260 L 1.300

G5 54 W

15 EVG

Schirm / shade / ABJ

135

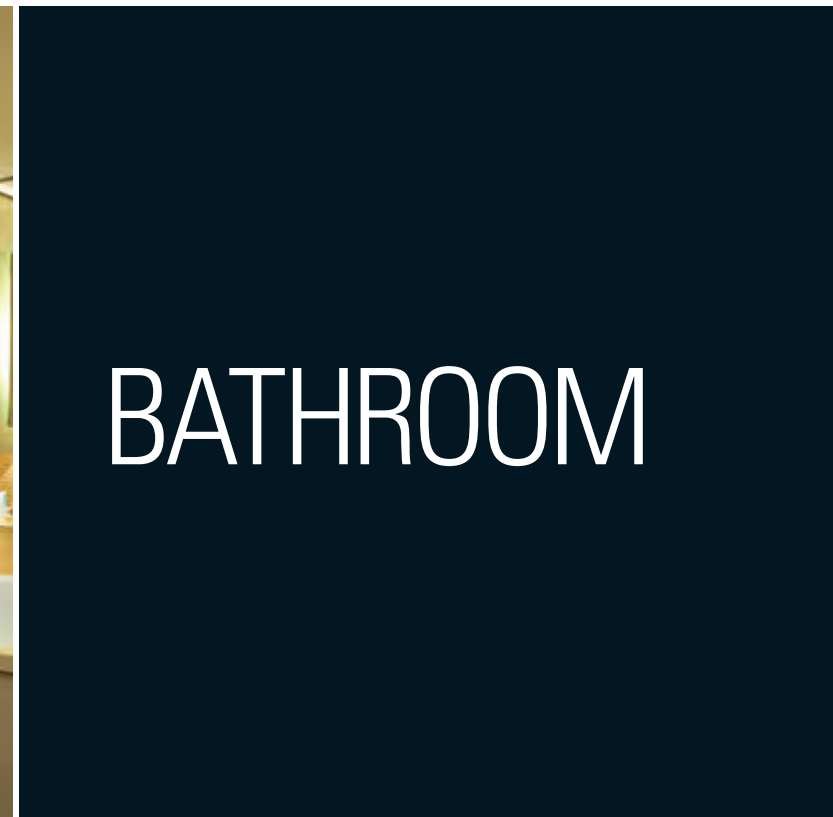

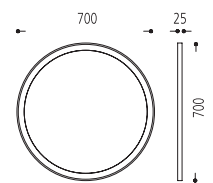
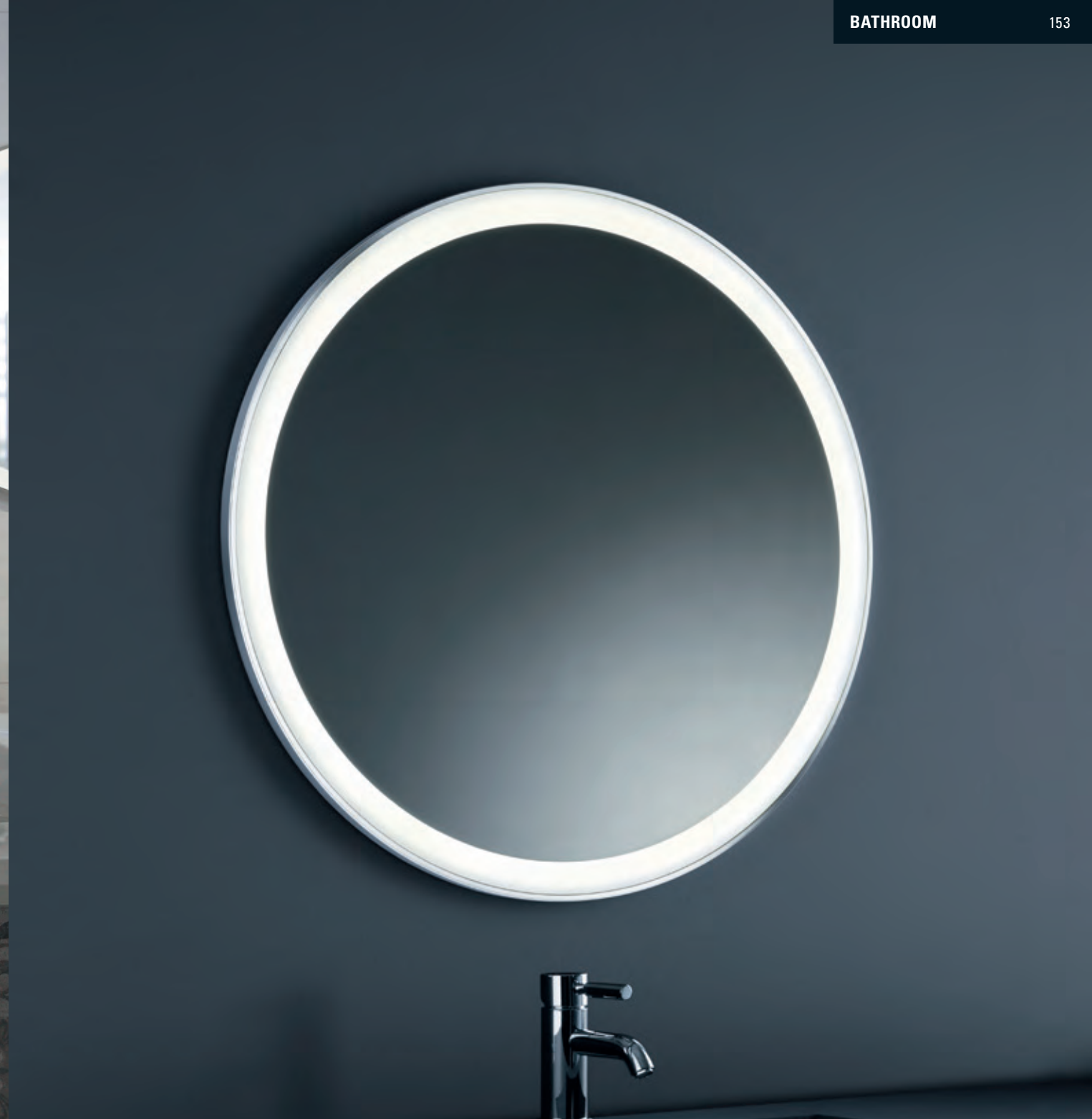

65.727...*

LED 18 W	3.000 K	SNT	IP44
----------	---------	-----	------

*Farbe / finish / couleur

19	69	81	82
----	----	----	----

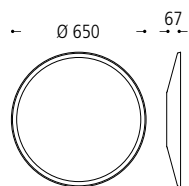

65.728.55

LED 18 W	3.000 K	SNT	IP44
----------	---------	-----	------

*Farbe / finish / couleur

55	XX
----	----



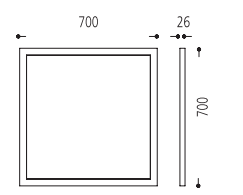

65.737.81

- 81
- LED 27 W
- 3.000 K
- SNT
- IP44

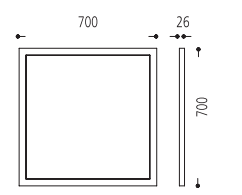
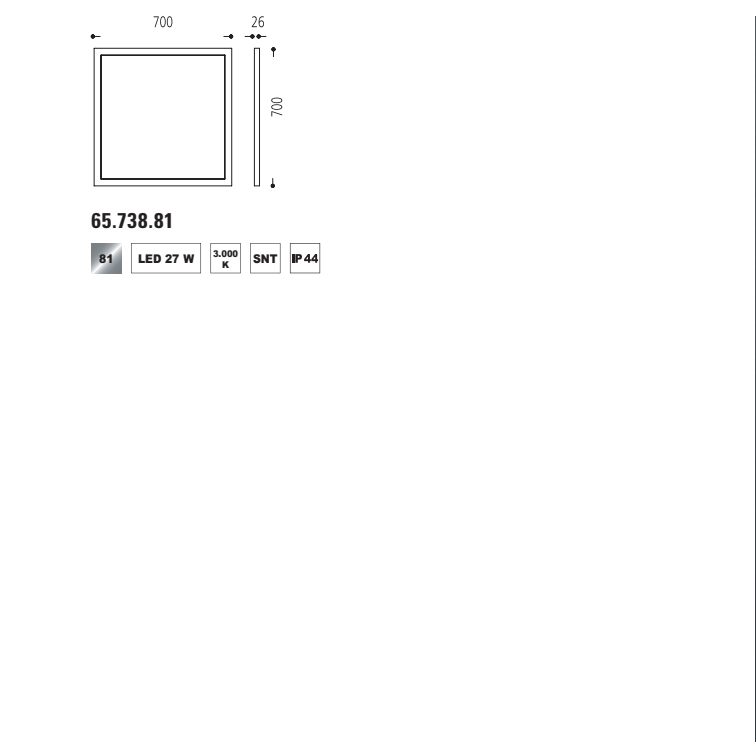

65.738.81

- 81
- LED 27 W
- 3.000 K
- SNT
- IP44

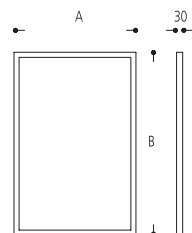

65.712...* A 600 B 900

LED 15 W

65.713...* A 800 B 1.000

LED 17 W

65.714...* A 800 B 1.200

LED 19 W

3.000 K SNT extern IP 44

*Farbe / finish / couleur

69 81



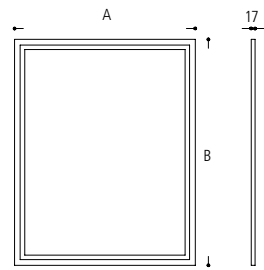

65.702.81 A 600 B 900

LED 15 W

65.703.81 A 800 B 1.000

LED 17 W

B1 3.000 K SNT extern IP44

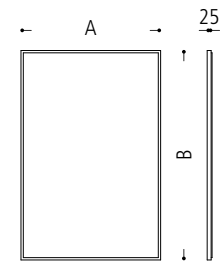

65.741.00 A 450 B 700

LED 12 W

65.742.00 A 600 B 800

LED 15 W

65.743.00 A 1200 B 700

LED 18 W

3.000 K SNT IP44



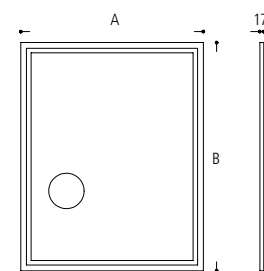

65.708.81 A 600 B 900

LED 15 W

65.709.81 A 800 B 1.000

LED 17 W

81 3.000 K SNT 44

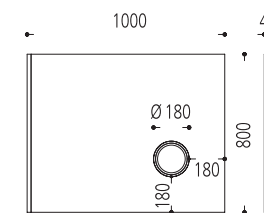

65.725.00

LED 10 W 3.000 K SNT 44

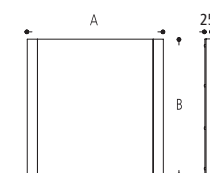

65.721.00 A 800 B 800

LED 25 W

65.726.00 A 1.000 B 800

LED 30 W

3.000
K

SNT

IP44

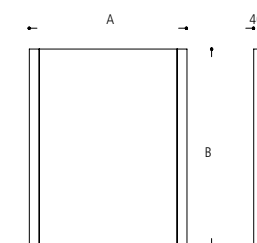

65.618.00 A 600 B 900

2 x G5
21 W

65.620.00 A 800 B 800

2 x G5
24 W

65.622.00 A 800 B 1.000

2 x G5
21 W

65.625.00 A 1.000 B 800

2 x G5
24 W

EVG

IP44



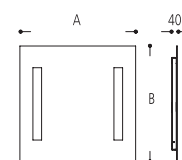

65.610.00 A 600 B 900

2 x G5
21 W

65.612.00 A 800 B 800

2 x G5
24 W

65.615.00 A 800 B 1.000

2 x G5
21 W

65.617.00 A 1.000 B 800

2 x G5
24 W

65.716.00 A 600 B 900

LED 16 W

65.717.00 A 800 B 800

LED 14 W

65.718.00 A 800 B 1.000

LED 18 W

65.719.00 A 1.000 B 800

LED 14 W

EVG IP44

3.000 K SNT IP44

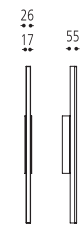

65.103.81 L 600

LED 6 W

65.104.81 L 900

LED 9 W

81 3,000 K SNT IP44

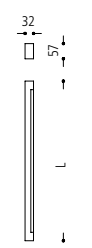

65.370.81 L 600

LED 6 W

65.371.81 L 900

LED 9 W

81 3,000 K SNT IP44



65.382.81 L 600

LED 6 W

65.383.81 L 900

LED 9 W

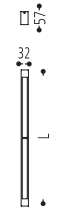

65.384.81 L 600

LED 6 W

65.385.81 L 900

LED 9 W

81 3,000 K SNT P44



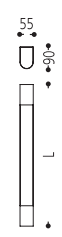

65.442.81 L 600

GS 14 W

65.443.81 L 800

GS 14 W

65.444.81 L 1.000

GS 21 W

65.445.81 L 1.200

GS 24 W

EVG

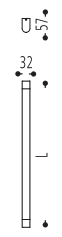

65.348.81 L 600

LED 6 W

65.349.81 L 900

LED 9 W

3.000 K SNT

B1 RP44





65.603...* L 300

S14s
LED 6 W

65.604...* L 500

S14s
LED 9 W

65.605...* L 1.000

S14s
LED 16 W

IP 20

*Farbe / finish / couleur

81 82

Design: Grimm / Kraege

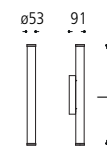

65.111...* L 600

LED 6 W

65.112...* L 900

LED 9 W

3.000 K SNT IP44

*Farbe / finish / couleur

14 55

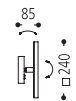

65.584.81

81

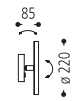

65.580.14

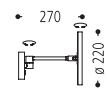

65.581.14

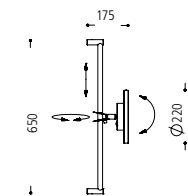

65.582.14

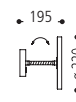

65.583.14

14

LED 3 W 3.000 K SNT IP40





65.295...*

*Farbe / finish / couleur

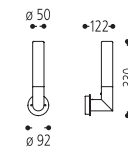

65.311.14

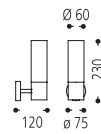

65.317.14

Farbe / finish / couleur

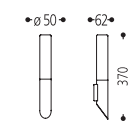

65.310.14



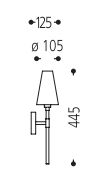

63.185.14-726

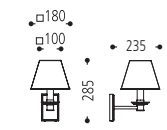

63.166.14-4130

Schirm/shade / ABJ

135

14 E14 IP20



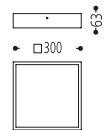

65.469.82

LED 14 W

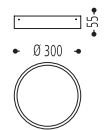

65.468.82

LED 10 W

82 3,000 K SNT IP44

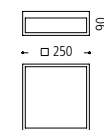

83.700.82



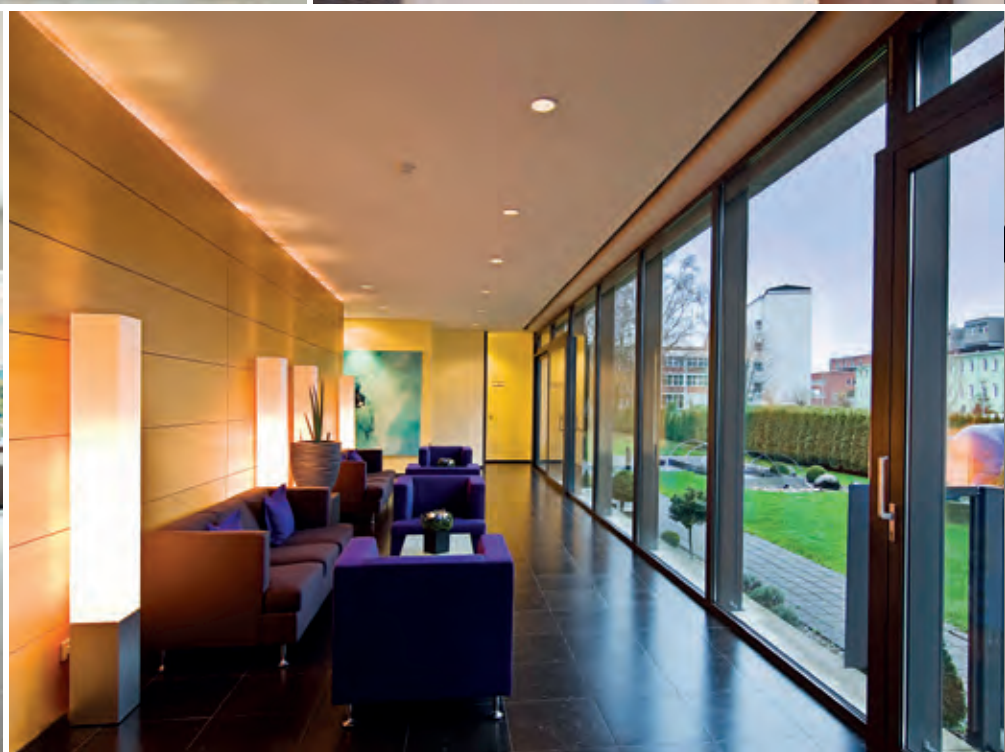

82 LED 10 W 3,000 K SNT IP40



Transformatoren / transformers / transformateurs
Schaltnetzteile / LED driver / convertisseur LED





























Baulmann-Nr. Baulmann-No. Baulmann-No.	VA VA VA	Primär- spannung Primary voltage Tension primaire	Sekundär- spannung Secondary voltage Tension secondaire	Schutzart Protection rating Type de protection	Schutz- klasse Protection class Classe de protection	ENEC / KEMA	VDE	 Sekundärkabelzuführung Secondary cable feeding Câble d'alimentation secondaire	Maße (mm) (ohne Kabelführung) Dimensions (mm) (without cable entry) Dimensions (mm) (sans introd. de câble)	L	B / W / L	H	Ø
elektronische Transformatoren / electronic transformers / transformateurs électroniques													
78.072.00	10-60	230 V	11,8 V	IP 20	II	x	x	x	Klemme / terminal / borne	104	36	22	
78.105.00	20-105	230 V	11,8 V	IP 20	II	x	x	x	Klemme / terminal / borne	111	37	28	
78.150.00	75-150	230 V	11,7 V	IP 20	II	x	x	x	Klemme / terminal / borne	167	39	30	
78.200.00	50-200	230 V	11,7 V	IP 20	II	x	x	x	Klemme / terminal / borne	200	37	30	
Schaltnetzteile / LED driver / convertisseur LED													
77.816.00	0-12 W	230 V	12 V / dc	IP 20	II	x		x	Klemme / terminal / borne	85	40	22	
77.830.00	0-20 W	230 V	12 V / dc	IP 20	II	x		x	Klemme / terminal / borne	167	38	29,5	
77.831.00	0-30 W	230 V	12 V / dc	IP 20	II			x	Klemme / terminal / borne	151	41	30	
78.001.00	0-1 W	230 V	350 mA	IP 20	II	x		x	Klemme / terminal / borne	58	39	20	
78.003.00	1-4 W	230 V	350 mA	IP 20	II	x		x	Klemme / terminal / borne	58	39	20	
78.006.00	1-8 W	230 V	350 mA	IP 20	II	x		x	Klemme / terminal / borne	58	35	21	
78.008.00	1-10 W	230 V	350 mA	IP 20	II	x		x	Litze / litz wire / âme tordonnée			24	55
78.019.00	1-18 W	230 V	350 mA	IP 20	II	x		x	Klemme / terminal / borne	153	67	30,5	

Zeichenerklärung / legend / légende

	Schalter / switch / interrupteur		Schutzart IP 44 / protection rating IP 44 / type de protection IP 44
	Ohne Schalter / without switch / sans interrupteur		Leuchten, geeignet zum Ein- oder Anbau in / an Einrichtungsgegenstände, die in ihrem Brandverhalten nicht bekannt sind / luminaires for direct installation in or on fixtures such as furniture items whose combustion characteristics are unknown / appareils d'éclairage pour l'installation directe dans ou sur du mobilier dont les caractéristiques de combustion sont inconnues
	Touch Dimmer / touch dimmer / variation tactile		
	Inkl. Schaltnetzteil / integrated LED driver included / incl. convertisseur LED		
	Inkl. Schaltnetzteil, lose beigelegt / remote LED driver included, added as loose part / incl. convertisseur LED, ajouté comme pièce détachée		
	Inkl. elektronischem Vorschaltgerät, nicht dimmbar / electronic ballast included, not dimmable / incl. self conventionelle électronique, non graduable		
	Inkl. elektronischem Vorschaltgerät / Schaltnetzteil, dimmbar 1-10 Volt / electronic ballast / LED driver included, dimmable 1-10 Volt / incl. self conventionelle électronique / convertisseur LED, graduable 1-10 Volt		
	elektr. Transformator / electronic transformer / transformateur électronique		
	Schutzart IP 20 / protection rating IP 20 / type de protection IP 20		
	Schutzart IP 40 / protection rating IP 40 / type de protection IP 40		

Oberflächen-Behandlung / surface treatment / traitement de surface

Die 6. und 7. Ziffer des Nummernblocks geben die nachstehend aufgeführte Oberfläche an / the 6th and 7th numeral of the numeration indicates
the surface treatment / les 6ème et 7ème chiffres de la numération vous indiquent le traitement de surface des luminaires

	Messing poliert / brass polished / laiton poli		Nickel blank-Esche tiefbraun / nickel polished-ash wood deep brown / nickel poli-bois de frêne bistre
	Messing matt / brass dull / laiton mat		Chrom-Nussbaum / chrome-nut tree / chrome-noyer
	Kupfer / copper / cuivre		Rubinrot / red / rouge
	Rostbraun / rust / rouille		Dunkel brüniert / dark bronzed / bronze foncé
	Chrom / chrome / chrome		Weiß / white / blanc
	Titansilber / silver / gris argenté		Schwarz-Gold / black-gold / noir-d'or
	Sterlingsilber / sterling silver / sterling argenté		Schwarz-Silber / black-silver / noir-argenté
	Nickel blank / nickel polished / nickel poli		Samt orange / velvet orange / velours orange
	Nickel matt / nickel dull / nickel mat		Samt violett / velvet violet / velours violet
	Nickel blank-Holz craquelé / nickel polished-cracked wood nickel poli-bois craquelé		Camouflage / camouflage / camouflage
	Taubenblau / powder blue dull / bleu pigeon mat		Schwarz / black / noir
	Samt grün / velvet green / velours vert		Edelstahl blank / stainless steel polished / acier poli
	Taupe / taupe / taupe		Edelstahl gebürstet / stainless steel dull / acier mat
	Creme hochglanz / cream high gloss / crème poli fin		Farbe wählbar / Color selectable / sélectionnable Couleur

Schirmstoffe / shade fabrics / abat-jour en tissu

101	Pongée sand, plissiert	pongée sand coloured, pleated	pongée couleur sable, plissé
103	Plisse champ	pleated champ	plissé champ
105	Contra H grob natur	contra H coarse nature	contra H grossier nature
128	Chintz grau	chintz grey	chintz gris
130	Chintz weiß	chintz white	chintz blanc
131	Chintz champ	chintz champ	chintz champ
132	Chintz gelb	chintz yellow	chintz jaune
135	Chintz naturweiß	chintz off white	chintz blanc
136	Taft schwarz	taffeta black	taffetas noir
139	Chintz schwarz - innen gold	chintz black - inside gold	chintz noir - à l'intérieur d'or
140	Leinenstruktur	linen-structure	toile-structure
141	Taft gold	taffeta gold	taffetas d'or
143	Leinen grau-beige	linen grey-beige	toile-structure beige-gris
144	Leinen champagner	linen champ	toile-structure champ
161	Chintz rostrot - innen Kupfer	chintz rust red - inside copper	chintz rouge - à l'intérieur cuivre
162	Chintz schlammfarben - innen gold	chintz olive - inside gold	chintz olive - à l'intérieur d'or
164	Chintz schwarz - innen Kupfer	Chintz black - inside copper	Chintz noir - à l'intérieur cuivre
200	Karton elfenbeinfarbig	cardboard white	couleur ivoire
702	Spiegelfolie Silber	silver mirror foil	feuille argenté
704	Spiegelfolie Kupfer	copper mirror foil	feuille cuivre
710	Polycarbonat	polycarbonate	polycarbonate

Allgemeine Hinweise

Für unsere Lieferungen und Leistungen gelten die „Allgemeinen Lieferbedingungen für Erzeugnisse und Leistungen der Elektroindustrie“ des ZVEI (Zentralverband Elektrotechnik- und Elektroindustrie e.V.) in ihrer neuesten Fassung. Zusätzlich gelten unsere Verkaufs-, Lieferungs- und Zahlungsbedingungen. Die aktuelle Version finden Sie unter www.baulmann.com.

Alle Leuchten sind nach EN 60598 gefertigt. Formale und technische Änderungen an unseren Produkten, die der Verbesserung dienen, behalten wir uns vor. Alle Abmessungen sind in mm angegeben und ca.-Angaben.

Fest eingebaute LED's sind Bestandteil der Leuchte. Alle anderen Leuchten liefern wir ohne Leuchtmittel. Nur Leuchtmittel mit den passenden elektrischen Daten (Sockel, Spannung, Watt) verwenden. Bei der Auftragserteilung sollten diese mitbestellt werden, um die Gewähr zu haben, dass die richtige Lampe eingesetzt wird.

Sonderanfertigungen

Neben der Herstellung unseres bewährten Leuchtenprogramms sind wir in der Lage, Leuchten nach Ihren Wünschen in Sonderanfertigung herzustellen. Diese Sonderanfertigungen beinhalten nicht nur die Abwandlung bezüglich Farbe oder Schirmmaterial der in diesem Katalog abgebildeten Leuchten, sondern auch die Fertigung spezieller Leuchten für die Lösung individueller Projektanforderungen. In diesem Fall senden Sie uns bitte Ihre spezifizierte Anfrage.

LED

In allen Kategorien unseres Programms sind zahlreiche Leuchten mit hochwertiger, leistungsfähiger und effizienter LED-Technik verfügbar. Die aktuellste Entwicklung im Bereich der LED-Technologie findet in unseren Produkten kontinuierlich Berücksichtigung. Trotz unserer strengen qualitativen Anforderungen können wir in der Farbtemperatur jedoch eine Toleranz von +/- 100 Kelvin nicht ausschließen.

Energieklassifizierung

Unsere Leuchten sind gem. EU-Verordnung 874/2012 energieklassifiziert. Detaillierte Hinweise hierzu finden Sie online unter www.baulmann.com.

General Terms and Conditions

For all our services and deliveries please refer to the latest version of the ZVEI (Zentralverband Elektrotechnik- und Elektroindustrie e.V. - the German Electrical and Electronic Manufacturers' Association) under „General delivery specifications for goods and services in the electrical industry“. In addition, our general sales, delivery and payment conditions apply. You can find the most current version under www.baulmann.com.

All lights are manufactured in accordance with EN 60598. We reserve the right to carry out any aesthetic and technical changes on our products that will serve to improve them. All measurements are provided in mm and are approximate indications.

Built-in LEDs form an integral part of certain lights. All other lights are delivered without bulbs. Use only bulbs with the applicable electrical data (base, voltage, watt). When placing the order, these should be included to guarantee the correct bulbs are used in the lights.

Custom-made Production

Aside from the manufacturing of our proven selection of lights, we are also able to produce custom-made lights. Not only do we customise the colour and material of the lampshades in our catalogue, we can also change the design of specific lights to meet individual project specifications. Please contact us to discuss your custom design requirements.

LED

In all categories of our program you will find numerous lights that perform with high-quality and efficient LED technology. We update our products with the latest developments in LED technology on a regular basis. Despite our stringent quality standards, we cannot, however, eliminate a tolerance of +/- 100 Kelvin in colour temperature.

Energy classification

Our lights are energy classified according to the EU regulation 874/2012. More details can be found online under www.baulmann.com.

Informations générales

Nos services et nos livraisons sont assujetties aux "conditions générales de livraison de produits et services de l'industrie électrique" de la ZVEI (Zentralverband Elektrotechnik- und Elektroindustrie e.V., c.a.d. la Fédération professionnelle des industries électrotechnique et électrique allemande) dans leur version la plus récente. Nos propres conditions de vente, de livraison et de paiement restent applicables en complément de celles-ci et dont la version actuelle peut être consultée à tout moment sur le site www.baulmann.com.

Tous nos luminaires sont fabriqués dans le respect de la norme (IEC) DIN EN 60598. Nous réservons le droit d'y apporter toute modification formelle ou technique visant à leur amélioration. Tous les mesures sont indiquées en mm, l'abréviation env. étant réservée aux données à caractère approximatif.

Les LEDs encastré (lampes à diodes électroluminescentes) sont des composants d'une partie de notre gamme de luminaires. Les luminaires de notre gamme qui n'en sont pas équipés sont fournis sans ampoules électriques. N'utiliser que des ampoules électriques conformes aux indications techniques prescrites (socle, tension, Watt). Nous recommandons de les requérir au moment de votre commande auprès de nos services, afin de garantir l'ajout de l'ampoule électrique adéquate au luminaire sélectionné.

Fabrication de modèles hors-série, sur mesure

À côté de notre gamme éprouvée de luminaires, nous sommes en mesure de produire des luminaires sur mesure, selon vos souhaits. Ces modèles hors-série portant sur des modifications en termes de couleur ou de matériau du chapeau par rapport aux modèles de notre catalogue, ils peuvent néanmoins exiger des spécificités techniques au niveau de la fabrication en raison d'exigences contingentes à tout projet individuel. Dans ce cas, nous vous prions de nous faire parvenir votre demande spécifique par écrit. remis. Dans ce cas, nous vous prions de nous envoyer une demande clairement spécifiée.

LED

De nombreux luminaires équipés de technique LED haut de gamme, performante et efficiente sont disponibles dans toutes les catégories de notre catalogue. Nous intégrons systématiquement les techniques LED les plus récentes dans le développement de nos luminaires. Malgré nos strictes exigences en matière de standards de qualité, nous ne pouvons exclure des écarts de température des couleurs de +/-100 Kelvin.

Energieklassifizierung

Nos luminaires sont conformes au règlement délégué (UE) n° 874/2012 de la Commission du 12 juillet 2012. Les indications détaillées relatives à cette réglementation sont consultables en ligne sur le site www.baulmann.com.

Installations- und Montagehinweise

Bei der Montage von Leuchten mit ESD-gefährdeten Bauteilen sind geltende ESD-Richtlinien und Vorschriften zu beachten.

Installationen müssen gemäß DIN VDE 0100 / IEC 364 ausgeführt werden. An Räumen mit Badewanne oder Dusche werden besondere Anforderungen gestellt, die in der DIN VDE 0100 Teil 701 definiert sind. Für unsere empfohlenen Leuchten am Waschtisch gelten keine besonderen Vorschriften. Es sind jedoch die definierten Abstände zur Dusche oder Badewanne einzuhalten.

Advice for installation and assembling

Please follow the prevailing ESD guidelines and directions when assembling lights with ESD-prone parts.

Installations should be carried out according to DIN VDE 0100 / IEC 364. Rooms with Bathtubs or Showers are subject to specific requirements as defined in DIN VDE 0100 section 701. Our recommended lights for washbasins are not subject to specific instructions. However, the specified distance to the shower or bathtub must be observed.

Montage et installation

Le montage de luminaires équipés de composant sensible ESD doit impérativement être effectué conformément aux directives en vigueur en matière de décharges électrostatiques (c.a.d. Electrostatic Discharge, ESD).

Toute installation doit être effectuée conformément aux normes DIN VDE 0100 / IEC 364 en vigueur. Les exigences spécifiques définies dans les normes DIN VDE 0100 partie 701 / IEC 60364-7-701 doivent être impérativement respectées dans les pièces équipées d'une baignoire ou d'une douche. Aucune prescription particulière n'est applicable à nos luminaires de lavabo. Néanmoins les distances prescrites vis-à-vis de la douche ou de la baignoire sont à respecter impérativement. Veuillez respecter également les indications en termes de sécurité, montage et installation publiées sur notre site Web. Veuillez également y consulter les courbes photométriques actuelles disponibles.

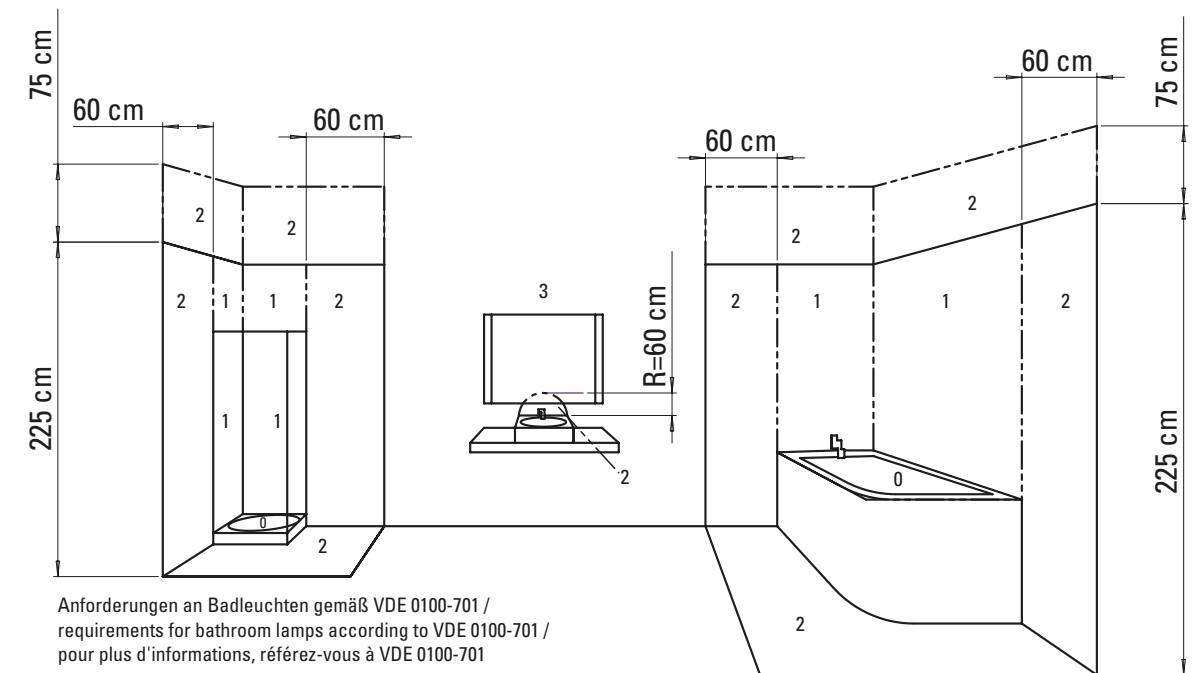

Anforderungen an Badleuchten gemäß VDE 0100-701 / requirements for bathroom lamps according to VDE 0100-701 / pour plus d'informations, référez-vous à VDE 0100-701

- Zone 0 = IPX7
- Zone 1 = IPX5
- Zone 2 = IPX4
- Zone 3 = IP20

Weiterführende Informationen erhalten Sie unter der DIN VDE 0100-701 / for further information please have a look at VDE 0100-701 / luminaire de salle de bain conforme à la norme VDE 0100-701

www.baulmann.com

Die Baulmann Website verknüpft unser umfassendes Leuchtenangebot und die Präsentation des Unternehmens mit aktuellen Anwendungsbeispielen, Referenzprojekten und neuesten Informationen.

www.baulmann.com

The Baulmann Website showcases the extensive selection of lights and offers details of the company, references and latest news and information.

www.baulmann.com

Vous pouvez consulter notre gamme de produits luminaires illustrée de mises en scène concrètes sur notre site Web www.baulmann.com ainsi que nos projets de référence, le profil de notre entreprise et nos plus récents communiqués.

Bildnachweis / picture credits / crédit photographique

Seite page page	Objekt project projet	Foto photo photo			
2/3	[m]eatery bar + restaurant, Dresden	supplied by Gewandhaus Dresden	123	Side Hotel, Hamburg	Andrea Flak, Hamburg
4 links oben	Canal House, Amsterdam	supplied by Curious Hotels	124 oben links	H'otello B01, München	H'Otello, München
4 rechts oben	SETA Hotel, Bad Neuenahr	Dominik Ketz, Bad Neuenahr	124 oben rechts	Atlantic Hotel, Bremen	supplied Atlantic Hotels
4 Mitte links	Steigenberger Hotel Am Kanzleramt, Berlin	supplied by Steigenberger Hotels AG	124 Mitte links	Atlantic Hotel, Lübeck	supplied Atlantic Hotels
4 Mitte rechts	Boulevard Hotel, Baku	Pasha Inshaat, MMC	124 Mitte rechts	Radisson Hotel, Leipzig	supplied by Radisson SAS
4 links unten	Holiday Inn Hotel, Frankfurt Airport	Stefan Effner, Offenbach	124 unten links	Boulevard Hotel, Baku	supplied by Boulevard Hotel Baku
4 rechts unten	25hours Hotel Bikini, Berlin	supplied by 25hours Hotel Company, Hamburg	124 unten rechts	Boulevard Hotel, Baku	supplied by Boulevard Hotel Baku
5 links oben	Pullman Berlin Schweizerhof	supplied by Pullman Berlin Schweizerhof	125 oben links	Thon Hotel, Oslo	supplied by Thon Hotels
5 rechts oben	Steigenberger Hotel Frankfurter Hof, Frankfurt	Soenne - Architekturfotograf, Aachen	125 oben rechts	Holiday Inn, Frankfurt	supplied by Holiday Inn Frankfurt
5 Mitte	Heidelberg Marriott Hotel	supplied by Heidelberg Marriott Hotel	125 Mitte	Cispa, Saarbrücken	Dr. Christian Lindig, Ahlden
5 links unten	Amanzoe Hotel, Kranidi-Argolida, Greece	Foss SA lighting design – Athens, Greece	125 unten	Marriott Hotel, Hamburg	Marriott Hamburg / Matthias Hamel
5 rechts unten	Hampton by Hilton, Berlin	Photo: Quabbe + Tessmann - Arch: ARP Architekten, Hamburg	128	InterContinental , Marseille - Hotel Dieu	IHG InterContinental Hotel Group / Eric Cuvillier
6	Sheraton Hotel, Zürich	reisememo.ch	131	The George Hotel, Hamburg	Andrea Flak, Hamburg
9	Marriott Hotel, Prag	supplied by Prague Marriott Hotel	133	Missionshaus der Pallottiner, Limburg/Lahn	Jörg Hempel, Aachen
13 oben	Hilton Hotel, Kopenhagen	Jönsson DesignLab, Bevis Design Associations, Hilton CPH Airport - Photo: Kira Ursem	134-135	Radisson Blu Resort, Bukovel	supplied by Radisson Bukovel
13 unten	Steigenberger Hotel Am Kanzleramt, Berlin	Soenne - Architekturfotograf, Aachen	137	Staatsoper, Hamburg	Andrea Flak, Hamburg
15	Hotel Die Halde, Oberried	supplied by Hotel Die Halde, Oberried	138	Kardinal-Schulte-Haus, Bergisch-Gladbach	supplied by Kardinal-Schulte-Haus
16	Haubers Alpenresort, Oberstaufen	supplied by Haubers Alpenresort	141	Weingut Max Müller I, Volkach	Stefan Meyer
18	Haubers Alpenresort, Oberstaufen	supplied by Haubers Alpenresort	144-145	Vodafone Campus, Düsseldorf	Vodafone / Jens Howorka
20	Hotel Platzhirsch, Fulda	supplied by Hotel Platzhirsch, Fulda	147	FU, Berlin	Stefan Müller-Neumann
26/27	The Romanos Luxury Collection, Costa Navarino	TEMES S.A.	148	cha cha, positive eating	Andrea Flak, Hamburg
31	Bavaria Boutique Hotel, München	supplied by Bavaria Boutique Hotel	149	cha cha, positive eating	Andrea Flak, Hamburg
32	Valdall Fjordhotell	supplied by Valdall Fjordhotell	150 oben	Steigenberger Hotel Frankfurter Hof, Frankfurt	Soenne - Architekturfotograf, Aachen
39	H'Otello K80, Berlin	supplied by H'Otello München	150 Mitte links	SETA Hotel, Bad Neuenahr	Dominik Ketz, Bad Neuenahr
41	Racketcentrum Hotel, Jönköping	supplied by Racketcentrum Schweden	150 Mitte rechts	InterContinental, Marseille - Hotel Dieu	IHG InterContinental Hotel Group / Eric Cuvillier
47		Iria Degen Interiors, Zürich	150 unten	Budersand Hotel - Golf und SPA, Sylt	BZ.COMM GmbH, Ffm. am Main / Jana Ebert
50 oben	25hours Langstraße, Zürich	Stephan Lemke for 25hours	151 oben links	Andaz, Amsterdam	supplied by Andaz, Amsterdam
50 unten	25hours Bikini Hotel, Berlin	supplied by 25hours Hotel Company, Hamburg	151 oben rechts	25hours Langstraße, Zürich	Stephan Lemke for 25hours
51	25hours Zürich West	supplied by 25hours Hotel Company, Zürich	151 Mitte	Hilton Hotel, Mainz	Hilton Mainz / Quabbe + Tessmann
55	Roomers, Baden-Baden	Steve Herud / Roomers	151 unten	Steigenberger Hotel Am Kanzleramt, Berlin	Soenne - Architekturfotograf, Aachen
57	Rica Hotel, Narvik	Gatis Rozenfelds, SIA 'F64 Photo Agency', Riga	152	Hotel Comète, Paris	supplied by Hotel Comète
58	Thon Hotel, Oslo	supplied by Thon Hotels	154	Budersand Hotel - Golf und SPA, Sylt	BZ.COMM GmbH, Ffm. am Main / Jana Ebert
60/61	Steigenberger Hotel Am Kanzleramt, Berlin	Soenne - Architekturfotograf, Aachen	167	Sheraton Hotel, Stockholm	Andrea Flak, Hamburg
63	Hotel 47°, Konstanz	supplied by Hotel 47° Konstanz	173	Atlantic Hotel, Bremen	supplied by Atlantic Hotels
69	Haubers Alpenresort, Oberstaufen	supplied by Haubers Alpenresort	175	Kardinal-Schulte-Haus, Bergisch-Gladbach	supplied by Kardinal-Schulte-Haus
73	SI Suites, Stuttgart	supplied by Apartment House SI Betriebs GmbH, Stuttgart	184 oben links	Depot 1899, Frankfurt-Sachsenhausen	supplied by Messe Frankfurt
75 oben	Lindner SPA und Golfresort Weimarer Land, Blankenhain	supplied by Spa & Golf Resort Weimarer Land Betriebsgesellschaft mbH	184 oben rechts	Roomers, Baden-Baden	supplied by Roomers Baden-Baden
75 unten	Rica Hotel Narvik	Gatis Rozenfelds, SIA 'F64 Photo Agency', Riga	184 Mitte links	Ibis Styles, Aalen	Quelle: Accor Hospitality, München Photo: Christoph Weiss
77	Kardinal-Schulte-Haus, Bergisch-Gladbach	supplied by Kardinal-Schulte-Haus	184 Mitte rechts	Rica Hotel, Narvik	Gatis Rozenfelds, SIA 'F64 Photo Agency', Riga
81	Hotel Ritter, Durbach	supplied by Hotel Ritter, Durbach	184 unten links	Hotel 47°, Konstanz	supplied by Hotel 47° Konstanz
85 oben	Interconti, Marseille	supplied by Interconti Marseille	184 unten rechts	Hotel Der Blaue Reiter, Karlsruhe	supplied by Hotel der Blaue Reiter GmbH & Co. KG, Karlsruhe
85 unten	The Romanos Luxury Collection, Costa Navarino	TEMES S.A.	185 oben	Marriott Hotel, Berlin	supplied by Berlin Marriott Hotel
87	Hotel Santa Tecla Palace	supplied by Santa Tecla, Italien	185 Mitte	Humboldt Universität, Berlin	supplied by Humboldt Universität zu Berlin
89	Schloss Elmau, Elmau	Schlosshotel Elmau	185 unten	SI-Suites, Stuttgart	supplied by Apartment House SI Betriebs GmbH, Stuttgart
90 oben	Intercity Hotel, Hannover	supplied by Intercity Hannover			
90 unten	Sheraton Hotel, Stockholm	Starwood Hotels & Resorts Worlwide, Inc.			
95	Hotel am Stadtgarten, Freiburg	supplied by Hotel am Stadtgarten			
99	The Romanos Luxury Collection, Costa Navarino	TEMES S.A.			
102-103	Chalet Christiania Zermatt	diesigner konzept GmbH (Design und Ausführung)			
104	Roomers, Baden-Baden	supplied by Roomers Baden-Baden			
106	Hampton by Hilton, Berlin	Photo: Quabbe + Tessmann - Arch: ARP Architekten, Hamburg			
109	Steigenberger Hotel Am Kanzleramt, Berlin	Soenne - Architekturfotograf, Aachen			
112 oben	Das BollAnts - SPA im Bad , Bad Sobernheim	supplied by BollAnts - SPA im Bad, Bad Sobernheim			
112 unten	Schloss Elmau, Elmau	Schlosshotel Elmau			
114	25hours Langstraße, Zürich	Stephan Lemke for 25hours			
119	Spielbank, Mainz	Mehler & Partner Design Agentur GmbH			

Inhalt / index / contenu

13.129.	95	14.157.33	63	24.129.01	29	63.150.33	68	64.065.	110	64.361.	17	65.612.00	167	83.768.55	142
13.145.09	89	14.162.	92	24.154.30	64	63.154.82	70	64.066.	110	64.363.	11	65.615.00	167	84.010.	121
13.148.09	89	14.234.	37	24.155.30	65	63.155.69	45	64.067.	110	64.364.	11	65.617.00	167	84.112.	120
13.150.33	69	14.244.	35	24.156.33	63	63.156.69	45	64.069.	110	64.400.14	64	65.618.00	165	84.115.	121
13.152.33	68	14.245.69	31	24.157.33	63	63.166.14	181	64.070.	110	64.420.14	64	65.620.00	165	84.116.	120
13.153.33	68	14.246.	32	24.162.	93	63.185.14	181	64.107.	24	64.501.	10	65.622.00	165	84.119.	118
13.154.82	70	14.249.	33	24.345.	18	63.185.33	96	64.108.	25	64.502.	10	65.625.00	165	84.129.	118
13.155.69	44	14.345.	20	24.400.14	64	63.301.30	73	64.109.	24	64.506.	11	65.702.81	160	84.139.82	118
13.156.69	56	14.346.	21	25.140.41	70	63.310.15	82	64.110.	25	64.580.	7	65.703.81	160	84.216.	118
13.157.69	57	15.140.41	70	33.208.15	84/95	63.311.30	76	64.129.	100	64.830.55	138	65.708.81	163	84.219.	120
13.158.	52/55	15.141.41	70	33.311.	79	63.312.30	76	64.145.	108	64.831.55	73/108	65.709.81	163	84.268.	113
13.160.	47	16.130.30	91	33.568.15	149	63.313.30	76	64.148.33	6	65.103.81	169	65.712.	158	84.269.	113
13.185.33	96	16.130.50	91	33.569.15	149	63.315.	77	64.149.33	6	65.104.81	169	65.713.	158	84.279.15	116
13.186.33	96	16.145.30	91	33.665.15	132	63.316.30	87	64.155.30	65	65.111.	176	65.714.	158	84.282.15	117
13.208.15	84	23.129.	95	33.667.15	132	63.317.30	87	64.163.	8	65.112.	176	65.716.00	167	84.283.15	116
13.309.15	82	23.131.	79	33.675.15	132	63.319.	77	64.164.	8	65.295.	178	65.717.00	167	84.285.15	116
13.310.15	82	23.145.09	89	33.677.15	132	63.320.30	73	64.165.	7	65.310.14	179	65.718.00	167	88.224.15	117
13.311.	78	23.148.09	89	33.700.	126/128	63.321.30	74	64.172.	9	65.311.14	179	65.719.00	167		
13.311.15	83	23.152.33	68	33.703.15	132	63.322.30	74	64.173.	9	65.317.14	178	65.721.00	165		
13.312.	78	23.153.33	68	33.751.15	84/140	63.323.	58	64.174.	7	65.348.81	174	65.725.00	163		
13.313.	78	23.154.82	70	33.752.15	138/140	63.324.	58	64.175.	7	65.349.81	174	65.726.00	165		
13.313.15	83	23.155.69	44	33.753.15	140	63.326.	39	64.176.	8	65.370.81	170	65.727.	152		
13.314.	78	23.156.69	56	33.754.15	140	63.409.15	81	64.177.	8	65.371.81	170	65.728.55	154		
13.315.	78	23.158.	52/55	33.905.15	130	63.703.69	43	64.182.	7	65.382.81	172	65.737.81	156		
13.316.30	87	23.159.69	41	34.122.69	106	63.704.30	66	64.234.	37	65.383.81	172	65.738.81	157		
13.317.30	87	23.160.	47	34.129.	100	63.705.30	66	64.235.	37	65.384.81	172	65.741.00	161		
13.323.	58	23.185.33	96	34.143.	104	63.706.30	66	64.244.	35	65.385.81	172	65.742.00	161		
13.325.	58	23.208.15	84	34.162.	93	63.754.55	143	64.245.69	31	65.442.81	174	65.743.00	161		
13.326.	39	23.310.15	82	34.185.33	96	63.755.55	143	64.246.	33	65.443.81	174	83.129.	114		
13.327.69	49	23.311.	79	34.284.	105	63.756.55	142	64.340.	14	65.444.81	174	83.342.54	98		
13.409.15	81	23.311.15	83	34.286.	105	63.757.55	142	64.341.	14	65.445.81	174	83.343.54	98		
13.703.69	43	23.315.	79	34.751.15	146	63.758.55	142	64.345.	17	65.468.82	182	83.344.54	98		
13.704.30	67	23.316.30	87	34.753.15	146	63.972.	108	64.345.69	16	65.469.82	182	83.700.82	183		
13.705.30	67	23.323.	58	34.754.15	146	63.980.82	108	64.347.	15	65.580.14	177	83.703.69	43		
13.728.69	49	23.326.	39	34.759.15	146	64.040.	110	64.348.	10	65.581.14	177	83.751.15	146		
14.106.	23	23.327.69	49	34.908.15	136	64.048.30	110	64.349.	10	65.582.14	177	83.752.15	146		
14.107.	23	23.409.15	81	63.101.	96	64.050.	110	64.351.	11	65.583.14	177	83.753.15	146		
14.108.69	28	23.703.69	43	63.103.	96	64.055.30	110	64.353.	12	65.584.81	177	83.754.55	143		
14.129.01	29	23.704.30	66	63.104.	96	64.056.30	110	64.354.	12	65.603.	176	83.755.55	143		
14.154.30	64	23.705.30	66	63.108.15	83	64.057.30	65	64.357.	122	65.604.	176	83.756.15	146		
14.155.30	65	24.107.	22	63.146.19	74	64.063.	110	64.359.	12	65.605.	176	83.766.55	142		
14.156.33	63	24.108.69	28	63.147.19	74	64.064.	110	64.360.	12	65.610.00	167	83.767.55	138/142		

BAULMANN LEUCHTEN

BAULMANN LEUCHTEN GMBH | P.O. BOX 1154, D – 59831 SUNDERN | SELSCHEDE WEG 24, D – 59846 SUNDERN
PHONE: +49(0)2933 847-0 | FAX: +49(0)2933 847-100 | E-MAIL: INFO@BAULMANN.COM | INTERNET: WWW.BAULMANN.COM